

PROGRAMMABLE CONTROLLERS
MELSEC-F

FX3U-CAN



USER'S MANUAL



FX3U

Safety Precautions

(Read these precautions before use.)

Before installation, operation, maintenance or inspection of this product, thoroughly read through and understand this manual and all of the associated manuals. Also, take care to handle the module properly and safely.

This manual classifies the safety precautions into two categories:  **WARNING** and  **CAUTION**.

 WARNING	Indicates that incorrect handling may cause hazardous conditions, resulting in death or severe injury.
 CAUTION	Indicates that incorrect handling may cause hazardous conditions, resulting in medium or slight personal injury or physical damage.

Depending on the circumstances, procedures indicated by  **CAUTION** may also cause severe injury. It is important to follow all precautions for personal safety.

Store this manual in a safe place so that it can be taken out and read whenever necessary. Always forward it to the end user.

1. DESIGN PRECAUTIONS



 WARNING	Reference
<ul style="list-style-type: none"> • Make sure to have the following safety circuits outside of the PLC to ensure safe system operation even during external power supply problems or PLC failure. Otherwise, malfunctions may cause serious accidents. <ol style="list-style-type: none"> 1) Most importantly, have the following: an emergency stop circuit, a protection circuit, an interlock circuit for opposite movements (such as normal vs. reverse rotation), and an interlock circuit (to prevent damage to the equipment at the upper and lower positioning limits). 2) Note that when the PLC CPU detects an error, such as a watchdog timer error, during self-diagnosis, all outputs are turned off. Also, when an error that cannot be detected by the PLC CPU occurs in an input/output control block, output control may be disabled. External circuits and mechanisms should be designed to ensure safe machinery operation in such a case. • For the operating status of each node in the case of a communication error, see the FX3U-CAN user's manual and the product manual of each node. Erroneous output or malfunctions may cause an accident. • When executing control (data changes) to an operating PLC, construct an interlock circuit in the sequence program so that the entire system operates safely. In addition, when executing control such as program changes and operation status changes (status control) to an operating PLC, carefully read the manual and sufficiently confirm safety in advance. Especially in control from external equipment to a PLC in a remote place, problems in the PLC may not be able to be handled promptly due to abnormality in data transfer. Construct an interlock circuit in the sequence program. At the same time, determine the actions in the system between the external equipment and the PLC for protection against abnormalities in data transfer. 	24

 CAUTION	Reference
<ul style="list-style-type: none"> • Make sure to observe the following precautions in order to prevent any damage to the machinery or accidents due to abnormal data written to the PLC under the influence of noise: <ol style="list-style-type: none"> 1) Do not bundle the main circuit line together with or lay it close to the main circuit, high-voltage line or load line. Otherwise, noise disturbance and/or surge induction are likely to take place. As a guideline, lay the control line at least 100mm (3.94") or more away from the main circuit or high-voltage lines. 2) Ground the shield wire or shield of a shielded cable. Do not use common grounding with heavy electrical systems (refer to the manual of the PLC main unit). 	24



Safety Precautions

(Read these precautions before use.)

2. INSTALLATION PRECAUTIONS

 WARNING	Reference
<ul style="list-style-type: none"> Make sure to cut off all phases of the power supply externally before attempting installation or wiring work. Failure to do so may cause electric shock or damage to the product. 	26
 CAUTION	Reference
<ul style="list-style-type: none"> Use the product within the generic environment specifications described in PLC main unit manual (Hardware Edition). Never use the product in areas with excessive dust, oily smoke, conductive dusts, corrosive gas (salt air, Cl₂, H₂S, SO₂ or NO₂), flammable gas, vibration or impacts, or expose it to high temperature, condensation, or rain and wind. If the product is used in such conditions, electric shock, fire, malfunctions, deterioration or damage may occur. Do not touch the conductive parts of the product directly. Doing so may cause device failures or malfunctions. When drilling screw holes or wiring, make sure that cutting and wiring debris do not enter the ventilation slits. Failure to do so may cause fire, equipment failures or malfunctions. Be sure to remove the dust proof sheet from the PLC's ventilation port when installation work is completed. Failure to do so may cause fire, equipment failures or malfunctions. Install the product on a flat surface. If the mounting surface is rough, undue force will be applied to the PC board, thereby causing nonconformities. Install the product securely using a DIN rail or mounting screws. Connect extension cables securely to their designated connectors. Loose connections may cause malfunctions. 	26

3. WIRING PRECAUTIONS

 WARNING	Reference
<ul style="list-style-type: none"> Make sure to cut off all phases of the power supply externally before attempting installation or wiring work. Failure to do so may cause electric shock or damage to the product. 	29
 CAUTION	Reference
<ul style="list-style-type: none"> Perform class D grounding (grounding resistance: 100Ω or less) to the shield of the twisted shield cable (refer to Subsection 4.2.3). Do not use common grounding with heavy electrical systems. When drilling screw holes or wiring, make sure cutting or wire debris does not enter the ventilation slits. Failure to do so may cause fire, equipment failures or malfunctions. Install module so that excessive force will not be applied to communication connectors or communication cables. Failure to do so may result in wire damage/breakage or PLC failure. Make sure to affix the CAN bus connector with fixing screws. Tightening torque should follow the specifications in the manual. Loose connections may cause malfunctions. Make sure to properly wire to the terminal block (CAN bus connector) in accordance with the following precautions. Failure to do so may cause electric shock, equipment failures, a short-circuit, wire breakage, malfunctions, or damage to the product. <ul style="list-style-type: none"> - The disposal size of the cable end should follow the dimensions described in the manual. - Tightening torque should follow the specifications in the manual. - Twist the end of strand wire and make sure that there are no loose wires. - Do not solder-plate the electric wire ends. - Do not connect more than the specified number of wires or electric wires of unspecified size. - Affix the electric wires so that neither the terminal block nor the connected parts are directly stressed. Make sure to observe the following precautions in order to prevent any damage to the machinery or accidents due to abnormal data written to the PLC under the influence of noise: <ol style="list-style-type: none"> 1) Do not bundle the main circuit line together with or lay it close to the main circuit, high-voltage line or load line. Otherwise, noise disturbance and/or surge induction are likely to take place. As a guideline, lay the control line at least 100 mm (3.94") or more away from the main circuit or high-voltage lines. 2) Ground the shield wire or shield of a shielded cable. Do not use common grounding with heavy electrical systems. Place the communication cable in grounded metallic ducts or conduits both inside and outside of the control panel whenever possible. 	29

Safety Precautions

(Read these precautions before use.)

4. STARTUP AND MAINTENANCE PRECAUTIONS

 WARNING	Reference
<ul style="list-style-type: none"> • Do not touch any terminal while the PLC's power is on. Doing so may cause electric shock or malfunctions. • Before cleaning or retightening terminals, cut off all phases of the power supply externally. Failure to do so may cause electric shock. • Before modifying or disrupting the program in operation or running the PLC, carefully read through this manual and the associated manuals and ensure the safety of the operation. An operation error may damage the machinery or cause accidents. 	193 194 198 215

 CAUTION	Reference
<ul style="list-style-type: none"> • Do not disassemble or modify the PLC. Doing so may cause fire, equipment failures, or malfunctions. For repair, contact your local Mitsubishi Electric representative. • Turn off the power to the PLC before connecting or disconnecting any extension cable. Failure to do so may cause equipment failures or malfunctions. • Do not drop the product or exert strong impact to it. Doing so may cause damage. • Turn off the power to the PLC before attaching or detaching the following devices. Failure to do so may cause equipment failures or malfunctions. <ul style="list-style-type: none"> - Peripheral devices, display module, expansion boards, and special adapters - Input/output extension units/blocks, FX Series terminal blocks and special function units/blocks - Battery and memory cassette 	194 198 215

5. DISPOSAL PRECAUTIONS

 CAUTION	Reference
<ul style="list-style-type: none"> • Please contact a certified electronic waste disposal company for the environmentally safe recycling and disposal of your device. 	24

6. TRANSPORTATION AND STORAGE PRECAUTIONS

 CAUTION	Reference
<ul style="list-style-type: none"> • The PLC is a precision instrument. During transportation, avoid impacts larger than those specified in the general specifications of the PLC main unit manual by using dedicated packaging boxes and shock-absorbing palletes. Failure to do so may cause failures in the PLC. After transportation, verify operation of the PLC and check for damage of the mounting part, etc. 	24

Safety Precautions

(Read these precautions before use.)

MEMO

FX3U-CAN

User's Manual

Manual number	JY997D43301
Manual revision	D
Date	8/2016

Foreword

This manual describes the FX3U-CAN Communication Block and should be read and understood before attempting to install or operate the hardware.

Store this manual in a safe place so that you can take it out and read it whenever necessary. Always forward it to the end user.

This manual confers no industrial property rights or any rights of any other kind, nor does it confer any patent licenses. Mitsubishi Electric Corporation cannot be held responsible for any problems involving industrial property rights which may occur as a result of using the contents noted in this manual.

Outline Precautions

- This manual provides information for the use of the FX3U-CAN Communication block. The manual has been written to be used by trained and competent personnel. The definition of such a person or persons is as follows;
 - 1) Any engineer who is responsible for the planning, design and construction of automatic equipment using the product associated with this manual should be of a competent nature, trained and qualified to the local and national standards required to fulfill that role. These engineers should be fully aware of all aspects of safety with aspects regarding to automated equipment.
 - 2) Any commissioning or maintenance engineer must be of a competent nature, trained and qualified to the local and national standards required to fulfill the job. These engineers should also be trained in the use and maintenance of the completed product. This includes being familiar with all associated manuals and documentation for the product. All maintenance should be carried out in accordance with established safety practices.
 - 3) All operators of the completed equipment should be trained to use that product in a safe and coordinated manner in compliance with established safety practices. The operators should also be familiar with documentation that is connected with the actual operation of the completed equipment.
- Note:** The term 'completed equipment' refers to a third party constructed device that contains or uses the product associated with this manual.

- This product has been manufactured as a general-purpose part for general industries, and has not been designed or manufactured to be incorporated in a device or system used in purposes related to human life.
- Before using the product for special purposes such as nuclear power, electric power, aerospace, medicine or passenger movement vehicles, consult with Mitsubishi Electric.
- This product has been manufactured under strict quality control. However when installing the product where major accidents or losses could occur if the product fails, install appropriate backup or failsafe functions into the system.
- When combining this product with other products, please confirm the standards and codes of regulation to which the user should follow. Moreover, please confirm the compatibility of this product with the system, machines, and apparatuses to be used.
- If there is doubt at any stage during installation of the product, always consult a professional electrical engineer who is qualified and trained in the local and national standards. If there is doubt about the operation or use, please consult your local Mitsubishi Electric representative.
- Since the examples within this manual, technical bulletin, catalog, etc. are used as reference; please use it after confirming the function and safety of the equipment and system. Mitsubishi Electric will not accept responsibility for actual use of the product based on these illustrative examples.
- The content, specification etc. of this manual may be changed for improvement without notice.
- The information in this manual has been carefully checked and is believed to be accurate; however, if you notice any doubtful point, error, etc., please contact your local Mitsubishi Electric representative.

Registration

- CiA[®] and CANopen[®] are registered Community Trademarks of CAN in Automation e.V.
- The company name and the product name to be described in this manual are the registered trademarks or trademarks of each company.

Table of Contents

SAFETY PRECAUTIONS	(1)
Standards	8
Certification of UL, cUL standards	8
Compliance with EC directive (CE Marking)	8
Associated Manuals	10
Generic Names and Abbreviations Used in the Manual	12
Reading the Manual	14

1. Introduction **15**

1.1 Outline.....	15
1.1.1 Overview of the CANopen® Network.....	15
1.1.2 Overview of FX3U-CAN communication block	16
1.1.3 Characteristics.....	16
1.2 External Dimensions and Each Part Name.....	18
1.2.1 External dimensions and each part name	18
1.2.2 Power and status LEDs	19
1.2.3 Terminal layout.....	19
1.3 System Configuration.....	20
1.3.1 General configuration	20
1.3.2 Applicable PLC.....	21
1.3.3 Connection with PLC.....	22
1.4 System Start-up Procedure.....	23

2. Specifications **24**

2.1 General Specifications	25
2.2 Power Supply Specifications.....	25
2.3 Performance Specifications	25

3. Installation **26**

3.1 Connection with PLC.....	26
3.2 Mounting	27
3.2.1 DIN rail mounting.....	27
3.2.2 Direct Mounting	28

4. Wiring **29**

4.1 Applicable Cable and Connector.....	29
4.1.1 Applicable connector	29
4.1.2 Applicable cable	30
4.1.3 Termination of cable end.....	30
4.1.4 Removal and installation of CAN bus connector	30
4.2 CAN-Bus Wiring	31
4.2.1 Connecting communication cables.....	31
4.2.2 Module wiring	31
4.2.3 Grounding of twisted pair cable.....	32
4.2.4 Termination.....	32
4.3 Grounding	32

5. Introduction of Functions	33
5.1 Functions List	33
5.2 Function Modes.....	33
5.3 Object Dictionary.....	34
5.4 Command Interface.....	34
5.5 Data Type Definition Area	35
5.6 Communication Profile Area	35
5.6.1 CAN-ID / COB-ID.....	55
5.6.2 Error Register	56
5.6.3 Pre-defined error field.....	56
5.6.4 SDO.....	56
5.6.5 RPDO / TPDO	57
5.6.6 MPDO.....	64
5.6.7 SYNC.....	65
5.6.8 Node guarding.....	66
5.6.9 Heartbeat.....	67
5.6.10 TIME.....	68
5.6.11 Store parameters.....	68
5.6.12 Restore default parameters.....	69
5.6.13 EMCY	69
5.7 Error Behaviour.....	71
5.8 Network Management.....	72
5.8.1 CANopen [®] Boot-Up Procedure and NMT states.....	72
5.8.2 Protocol Boot-Up	73
5.8.3 Protocol NMT (Node control).....	73
5.8.4 NMT slave identification	74
5.8.5 NMT master startup.....	74
5.8.6 NMT slave startup	78
5.8.7 NMT slave assignment.....	80
5.8.8 NMT Bootup / Error Event handling.....	82
5.8.9 Request NMT	83
5.8.10 Request node guarding	84
5.8.11 Flying Master	84
5.8.12 LSS.....	87
5.8.13 Configuration manager.....	87
5.9 Device Profile CiA [®] 405 V2.0 for IEC 61131-3 Programmable Devices.....	89
5.10 Application Profile CiA [®] 417 V2.1 for Lift Control Systems.....	91
5.10.1 Lift number.....	94
5.10.2 Virtual input mapping.....	95
5.10.3 Virtual output mapping.....	97
5.10.4 Door control word	100
5.10.5 Door status word	101
5.10.6 Light barrier status.....	103
5.10.7 Control word	103
5.10.8 Status word.....	105
5.10.9 Modes of operation.....	106
5.10.10 Modes of operation display.....	106
5.10.11 Target position.....	106
5.10.12 Load value.....	106
5.10.13 Load signalling.....	106
6. Allocation of Buffer Memories	107
6.1 Buffer Memories (BFM) Lists	107
6.2 How to Read/Write from/to Buffer Memory	110
6.2.1 Direct specification of buffer memory (FX3U/FX3UC/FX5U/FX5UC only)	110
6.2.2 FROM/TO instructions.....	110
6.3 Receive/Transmit Process Data.....	111

6.4 [BFM #20] Data Exchange Control	111
6.5 [BFM #21] Function Mode.....	112
6.6 [BFM #22] Save/Restore Configuration	113
6.7 [BFM #24] Baud Rate.....	114
6.8 [BFM #25] Communication Status	114
6.9 [BFM #26] FROM/TO Watchdog.....	116
6.10 [BFM #27] Node Address.....	116
6.11 [BFM #29] Error Status	116
6.12 [BFM #30] Module ID Code.....	116
6.13 [BFM #35] CAN Transmission Error Counter.....	117
6.14 [BFM #36] CAN Reception Error Counter	117
6.15 [BFM #37] Baud Rate Display	117
6.16 [BFM #38] Sampling Point Display.....	117
6.17 [BFM #39] BFM Setting Error Display	117
6.18 [BFM #40] BFM Initialisation/Online Mode Write Error Display.....	117
6.19 [BFM #50 to #59] Time Stamp	118
6.20 [BFM #70] NMT Start all Nodes delay.....	119
6.21 [BFM #71] SDO Time out.....	119
6.22 [BFM #601 to #727] NMT State	120
6.23 [BFM #750 to #859] Emergency Message Buffer	121
6.24 [BFM #900 to #963] NMT Error Control Status	123

7. CANopen[®] 405 Mode

124

7.1 Data Transfer Location for CANopen [®] 405 Mode.....	124
7.1.1 Direct TO BFM Access to the CANopen [®] 405 Object.....	124
7.1.2 Direct FROM BFM access to the CANopen [®] 405 Object.....	126
7.2 PDO Mapping/Binding of the Network for CANopen [®] 405 Mode	128
7.2.1 TPDO mapping table	129
7.2.2 RPDO mapping table.....	132
7.2.3 Mode 0 mapping.....	135
7.2.4 Mode A mapping	135
7.2.5 Mode B COB-ID mapping.....	136
7.2.6 Mode B COB-ID Mapping Errors.....	140

8. CANopen[®] 417 Mode

141

8.1 Buffer Memories Lists of Lift Application	141
8.2 Lift Number.....	152
8.3 Virtual Input/Output Mapping	152
8.3.1 Virtual input mapping.....	152
8.3.2 Virtual output mapping.....	155
8.4 Door Control Word/Door Status Word.....	159
8.4.1 Door control word	159
8.4.2 Door status word	160
8.5 Door Position.....	161
8.6 Light Barrier Status	161
8.7 Position Value	161
8.8 Speed Value Car.....	162
8.9 Acceleration Value Car	162
8.10 Control Word/Status Word	162
8.10.1 Control word	162
8.10.2 Status word.....	164
8.11 Modes of operation/Modes of operation display	165
8.11.1 Modes of operation.....	165
8.11.2 Modes of operation display.....	165

8.12 Control Effort	165
8.13 Position Actual Value/Target Position	165
8.13.1 Position actual value	165
8.13.2 Target position	166
8.14 Profile Velocity	166
8.15 Velocity Actual Value/Target Velocity	166
8.15.1 Target velocity	166
8.15.2 Velocity actual value	166
8.16 Load Value	166
8.17 Load Signalling	166

9. CAN Layer 2 Mode **167**

9.1 Receive/Transmit Process Data	167
9.2 Layer 2 Message Specific Error Code List	170
9.3 Pre-defined Layer 2 Message Configuration	170
9.3.1 Pre-defined Layer 2 transmit messages	171
9.3.2 Pre-defined Layer 2 receive messages	173
9.4 Layer 2 RTR Flags	175
9.5 Message Transmit Trigger Flags	176
9.6 PLC RUN>STOP Messages	176
9.7 CIF Sending Layer 2 Message	178

10. Command Interface **179**

10.1 [BFM #1000 to #1066] Command Interface	179
10.2 SDO Request	180
10.2.1 CIF SDO read access	180
10.2.2 CIF Multi SDO read access	181
10.2.3 CIF SDO write access	182
10.2.4 CIF Multi SDO write access	183
10.3 Set Heartbeat	184
10.4 Set Node Guarding / NMT Slave Assignment	185
10.5 Send an Emergency Message	186
10.6 Store Object Dictionary Settings	188
10.7 Restore Object Dictionary Default Settings	189
10.8 Display Current Parameter	189
10.9 Error Messages	190
10.9.1 Error messages	190
10.9.2 CIF busy message	192

11. PLC RUN/STOP **193**

12. Communication Settings Procedure **194**

12.1 CANopen [®] 405 Mode	195
12.2 CANopen [®] 417 Mode	196
12.3 11 bit / 29 bit CAN-ID Layer 2 Mode	197

13. Program Example	198
13.1 System Configuration.....	198
13.2 Local Label Setting.....	199
13.3 Program	202
<hr/>	
14. Diagnostics	215
14.1 Preliminary Checks	215
14.2 Detail Error Check.....	217
Warranty	219
Revised History	220

Standards

Certification of UL, cUL standards

FX3U-CAN units comply with the UL standards (UL, cUL).

UL, cUL File number :E95239

Regarding the standards that comply with the main unit, please refer to either the FX series product catalog or consult with your nearest Mitsubishi product provider.

Compliance with EC directive (CE Marking)

This document does not guarantee that a mechanical system including this product will comply with the following standards.

Compliance to EMC directive and LVD directive for the entire mechanical module should be checked by the user / manufacturer. For more information please consult with your nearest Mitsubishi product provider.

Regarding the standards that comply with the main unit, please refer to either the FX series product catalog or consult with your nearest Mitsubishi product provider.

Requirement for Compliance with EMC directive

The following products have shown compliance through direct testing (of the identified standards below) and design analysis (through the creation of a technical construction file) to the European Directive for Electromagnetic Compatibility (2014/30/EU) when used as directed by the appropriate documentation.

Attention

This product is designed for use in industrial applications.

Type: Programmable Controller (Open Type Equipment)

Models: MELSEC FX3U series manufactured
from April 1st, 2012 FX3U-CAN

Standard	Remark
EN61131-2:2007 Programmable controllers - Equipment requirements and tests	Compliance with all relevant aspects of the standard. EMI • Radiated Emission • Conducted Emission EMS • Radiated electromagnetic field • Fast transient burst • Electrostatic discharge • High-energy surge • Voltage drops and interruptions • Conducted RF • Power frequency magnetic field

Caution for Compliance with EC Directive

- 1) Caution for wiring
For noise prevention, please ground at least 35 mm (1.38") of the twisted-pair cable along the grounding plate to which the ground terminal is connected.
→ For details regarding wiring, refer to Section 4.2
 - 2) Installation in Enclosure
→ For details regarding installation in an enclosure of FX3G Series PLC, refer to FX3G User's Manual - Hardware Edition
→ For details regarding installation in an enclosure of FX3GC^{*1} Series PLC, refer to FX3GC User's Manual - Hardware Edition
→ For details regarding installation in an enclosure of FX3U Series PLC, refer to FX3U User's Manual - Hardware Edition
→ For details regarding installation in an enclosure of FX3UC^{*1} Series PLC, refer to FX3UC User's Manual - Hardware Edition
→ For details regarding installation in an enclosure of FX5U^{*2} PLC, refer to MELSEC iQ-F FX5U User's Manual (Hardware)
→ For details regarding installation in an enclosure of FX5UC^{*2} PLC, refer to MELSEC iQ-F FX5UC User's Manual (Hardware)
- *1. An FX2NC-CNV-IF or FX3UC-1PS-5V is necessary to connect the FX3U-CAN to an FX3GC/FX3UC Series PLC.
- *2. An FX5-CNV-BUS or FX5-CNV-BUSC is necessary to connect the FX3U-CAN to an FX5U/FX5UC PLC.

Associated Manuals

Only the installation manual is packed together with the FX3U-CAN Communication Block.

For a detailed explanation of the FX3U-CAN, refer to this manual.

For further information of the hardware information and instructions on the PLC main unit/CPU Module, refer to the respective manuals.

- ⊙ Refer to these manuals
- ✓ Refer to the appropriate equipment manual
- △ For a detailed explanation, refer to an additional manual

	Title of manual	Document number	Description	Model code	
Manual for the Main Unit/CPU Module					
FX3G Series PLCs Main Unit					
△	Supplied Manual	FX3G Series Hardware Manual	JY997D46001	Describes FX3G Series PLC specification for I/O, wiring and installation extracted from the FX3G User's Manual - Hardware Edition. For details, refer to FX3G Series User's Manual - Hardware Edition.	-
⊙	Additional Manual	FX3G Series User's Manual - Hardware Edition	JY997D31301	Describes FX3G Series PLC specification details for I/O, wiring, installation and maintenance.	09R521
FX3GC Series PLCs Main Unit					
△	Supplied Manual	FX3GC Series Hardware Manual	JY997D45201	Describes FX3GC Series PLC specification for I/O, wiring and installation extracted from the FX3G User's Manual - Hardware Edition. For details, refer to FX3GC Series User's Manual - Hardware Edition.	-
⊙	Additional Manual	FX3GC Series User's Manual - Hardware Edition	JY997D45401	Describes FX3GC Series PLC specification details for I/O, wiring, installation and maintenance.	09R533
FX3U Series PLCs Main Unit					
△	Supplied Manual	FX3U Series Hardware Manual	JY997D50301	Describes FX3U Series PLC specification for I/O, wiring and installation extracted from the FX3U User's Manual - Hardware Edition. For details, refer to FX3U Series User's Manual - Hardware Edition.	-
⊙	Additional Manual	FX3U Series User's Manual - Hardware Edition	JY997D16501	Describes FX3U Series PLC specification details for I/O, wiring, installation and maintenance.	09R516
FX3UC Series PLCs Main Unit					
△	Supplied Manual	FX3UC(D,DS,DSS) Series Hardware Manual	JY997D50501	Describes FX3UC(D,DS,DSS) Series PLC specification for I/O, wiring and installation extracted from the FX3UC Series User's Manual - Hardware Edition. For details, refer to FX3UC Series User's Manual - Hardware Edition.	-
△	Supplied Manual	FX3UC-32MT-LT-2 Hardware Manual	JY997D31601	Describes FX3UC-32MT-LT-2 specification for I/O, wiring and installation extracted from the FX3UC User's Manual - Hardware Edition. For details, refer to FX3UC Series User's Manual - Hardware Edition.	-
△	Supplied Manual	FX3UC-32MT-LT Hardware Manual (Only Japanese document)	JY997D12701	Describes FX3UC-32MT-LT specification for I/O, wiring and installation extracted from the FX3UC User's Manual - Hardware Edition. For details, refer to FX3UC Series User's Manual - Hardware Edition.	-
⊙	Additional Manual	FX3UC Series User's Manual - Hardware Edition	JY997D28701	Describes FX3UC Series PLC specification details for I/O, wiring, installation and maintenance.	09R519

		Title of manual	Document number	Description	Model code
FX5U PLCs CPU Module					
△	Supplied Manual	MELSEC iQ-F FX5U CPU Module Hardware Manual	JY997D53401	Describes FX5U PLC specification for I/O, wiring and installation extracted from the FX5U PLC from MELSEC iQ-F FX5U User's Manual (Hardware). For details, refer to FX5U PLC from MELSEC iQ-F FX5U User's Manual (Hardware).	-
⊙	Additional Manual	MELSEC iQ-F FX5U User's Manual (Hardware)	JY997D55301	Describes FX5U PLC specification details for I/O, wiring, installation and maintenance.	09R536
FX5UC PLCs CPU Module					
△	Supplied Manual	MELSEC iQ-F FX5UC CPU Module Hardware Manual	JY997D61001	Describes FX5UC PLC specification for I/O, wiring and installation extracted from the FX5UC PLC from MELSEC iQ-F FX5UC User's Manual (Hardware). For details, refer to FX5UC PLC from MELSEC iQ-F FX5UC User's Manual (Hardware).	-
⊙	Additional Manual	MELSEC iQ-F FX5UC User's Manual (Hardware)	JY997D61401	Describes FX5UC PLC specification details for I/O, wiring, installation and maintenance.	09R558
Programming					
⊙	Additional Manual	FX3S/FX3G/FX3GC/FX3U/FX3UC Series Programming Manual - Basic & Applied Instruction Edition	JY997D16601	Describes FX3S/FX3G/FX3GC/FX3U/FX3UC Series PLC programming for basic/applied instructions and devices.	09R517
✓	Additional Manual	MELSEC-Q/L/F Structured Programming Manual (Fundamentals)	SH-080782	Programming methods, specifications, functions, etc. required to create structured programs.	13JW06
✓	Additional Manual	FX CPU Structured Programming Manual [Device & Common]	JY997D26001	Devices, parameters, etc. provided in structured projects of GX Works2.	09R925
✓	Additional Manual	FX CPU Structured Programming Manual [Basic & Applied Instruction]	JY997D34701	Sequence instructions provided in structured projects of GX Works2.	09R926
✓	Additional Manual	FX CPU Structured Programming Manual [Application Functions]	JY997D34801	Application functions provided in structured projects of GX Works2.	09R927
✓	Additional Manual	MELSEC iQ-F FX5 Programming Manual (Program Design)	JY997D55701	Describes specifications of ladders, ST, FBD/LD, and other programs and labels.	09R538
⊙	Additional Manual	MELSEC iQ-F FX5 Programming Manual (Instructions, Standard Functions/Function Blocks)	JY997D55801	Describes specifications of instructions and functions that can be used in programs.	09R539
Manuals for FX3U-CAN Communication Block					
△	Supplied Manual	FX3U-CAN Installation Manual	JY997D43201	Describes some of FX3U-CAN communication block specifications for installation and wiring extracted from the FX3U-CAN User's Manual. For details, refer to FX3U-CAN User's Manual.	-
⊙	Additional Manual	FX3U-CAN User's Manual (This Manual)	JY997D43301	Describes details of the FX3U-CAN communication block.	-

Generic Names and Abbreviations Used in the Manual

Generic name or abbreviation	Description
PLC	
FX3G series	Generic name for FX3G Series PLC
FX3G PLC or main unit	Generic name for FX3G Series PLC main unit
FX3GC series	Generic name for FX3GC Series PLC
FX3GC PLC or main unit	Generic name for FX3GC Series PLC main unit
FX3U series	Generic name for FX3U Series PLC
FX3U PLC or main unit	Generic name for FX3U Series PLC main unit
FX3UC series	Generic name for FX3UC Series PLC
FX3UC PLC or main unit	Generic name for FX3UC Series PLC main unit
FX5U	Generic name for FX5U PLC
FX5U PLC or CPU module	Generic name for FX5U PLC CPU module
FX5UC	Generic name for FX5UC PLC
FX5UC PLC or CPU module	Generic name for FX5UC PLC CPU module
Expansion board	Generic name for expansion board The number of connectable units, however, depends on the type of main unit. To check the number of connectable units, refer to the User's Manual - Hardware Edition of the main unit to be used for your system.
Special adapter	Generic name for high-speed input/output special adapter, communication special adapter, analog special adapter, and CF card special adapter. The number of connectable units, however, depends on the type of main unit. To check the number of connectable units, refer to the User's Manual - Hardware Edition of the main unit to be used for your system.
I/O extension unit/block	Generic name for input/output powered extension unit and input/output extension block The number of connectable units, however, depends on the type of main unit. To check the number of connectable units, refer to the User's Manual - Hardware Edition of the main unit to be used for your system.
Special function unit/block or Special extension unit	Generic name for special function unit and special function block The number of connectable units, however, depends on the type of main unit. To check the number of connectable units, refer to the User's Manual - Hardware Edition of the main unit to be used for your system.
Special function unit	Generic name for special function unit
Special function block	Generic name for special function block
FX3U-CAN	Abbreviated name for FX3U-CAN
Memory cassette	Generic name for memory cassette. The number of connectable units, however, depends on the type of main unit. To check the number of connectable units, refer to the User's Manual - Hardware Edition of the main unit to be used for your system.
FX Series terminal block	Generic name for FX Series terminal block. The number of connectable units, however, depends on the type of main unit. To check the number of connectable units, refer to the User's Manual - Hardware Edition of the main unit to be used for your system.
Peripheral unit	
Peripheral unit	Generic name for programming software, handy programming panel, and indicator
Programming tool	
Programming tool	Generic name for programming software and handy programming panel
Programming software	Generic name for programming software
GX Works2	Abbreviation of programming software packages SW□DNC-GXW2-J/SW□DNC-GXW2-E
GX Developer	Abbreviation of programming software packages SW□D5C-GPPW-J/SW□D5C-GPPW-E
Handy programming panel (HPP)	Generic name for FX-30P and FX-20P(-E)

Generic name or abbreviation	Description
Indicator	
GOT1000 series	Generic name for GT15, GT11 and GT10
GOT-900 series	Generic name for GOT-A900 series and GOT-F900 series
GOT-A900 series	Generic name for GOT-A900 series
GOT-F900 series	Generic name for GOT-F900 series
ET-940 series	Generic name for ET-940 series
Manual	
FX3G Hardware Edition	Abbreviation of FX3G Series User's Manual - Hardware Edition
FX3GC Hardware Edition	Abbreviation of FX3GC Series User's Manual - Hardware Edition
FX3U Hardware Edition	Abbreviation of FX3U Series User's Manual - Hardware Edition
FX3UC Hardware Edition	Abbreviation of FX3UC Series User's Manual - Hardware Edition
Programming manual	Generic name for FX3S/FX3G/FX3GC/FX3U/FX3UC Series Programming Manual - Basic and Applied Instruction Edition, MELSEC iQ-F FX5 Programming Manual (Program Design), and MELSEC iQ-F FX5 Programming Manual (Instructions, Standard Functions/Function Blocks)
Communication control Edition	Abbreviation of FX Series User's Manual - Data Communication Edition
Analog control Edition	Abbreviation of FX3S/FX3G/FX3GC/FX3U/FX3UC Series User's Manual - Analog Control Edition
Positioning control Edition	Abbreviation of FX3S/FX3G/FX3GC/FX3U/FX3UC Series User's Manual - Positioning Control Edition
CANopen[®] communication term	
U8, U16, U32, U48	Unsigned Integer x Bit
I8, I16, I32	Signed Integer x Bit
Visible String	String of ISO646 bit coded characters which end after the last character.
Domain	Large block of binary data.
CAN	Controller Area Network
CANopen [®]	CAN based higher-layer protocol
CAN-ID	CAN Identifier Identifier for CAN data and remote frames as defined in ISO11898-1
CiA [®]	CAN in Automation Non-profit organization for standardization of CAN protocols. The CiA [®] Members develop specifications which are published as CiA [®] specifications. (http://can-cia.org/)
COB-ID	Communication object identifier Identifier that contains the CAN-ID and additional control bits.
RPDO	Receive Process Data Objects are data received from other nodes via the CAN bus.
TPDO	Transmit Process Data Objects are data sent to other nodes via the CAN bus.
MPDO	Multiplexed Process Data Object
SDO	Service Data Object
SYNC	Synchronization object
EMCY	Emergency object
NMT	Network management
LSS	Layer Setting Services
OSC	Open Style Connector
RTR	Remote transmission request
VD	Virtual Device

Reading the Manual

Shows the manual title.

This area shows the manual title for the current page.

Shows the title of the chapter and the title of the section.

This area shows the title of the chapter and the title of the section for the current page.

Indexes the chapter number.

The right side of each page indexes the chapter number for the page currently opened.

FX3U-CAN User's Manual
3 Installation
3.2 Mounting

3.2 Mounting

The FX3U-CAN may be installed in a control cabinet with a 35 mm wide DIN46277 DIN rail mounting or M4 screw direct mounting.

3.2.1 DIN rail mounting

The product may be mounted on a 35 mm wide DIN46277 (DIN rail).

- 1 Fit the upper edge (A in the figure to the right) of the DIN rail mounting groove onto the DIN rail.**
- 2 Push the product onto the DIN rail.**
 - An interval space of 1 to 2 mm (0.04" to 0.08") between each unit is necessary.
- 3 Connect the extension cable.**

Connect the extension cable (B in the figure to the right) to the main unit, I/O extension unit/block or special function unit/block on the left side of the product.
For further information of the extension cable connection procedure, refer to the respective product PLC manual.

- Refer to FX3G Hardware Edition
- Refer to FX3GC Hardware Edition
- Refer to FX3U Hardware Edition
- Refer to FX3UC Hardware Edition
- Refer to MELSEC iQ-F FX5U User's Manual (Hardware)
- Refer to MELSEC iQ-F FX5UC User's Manual (Hardware)

• Example of installation on DIN rail

- In the case of the FX3G/FX3U PLC

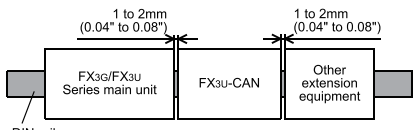
- In the case of the FX3GC/FX3UC PLC

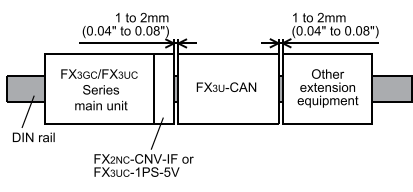

1 Introduction

2 Specifications

3 Installation

4 Wiring

5 Introduction of Functions

6 Allocation of Buffer Memories

7 Interface and Device Profile (4th mode)

8 Lift Application Profile (4th mode)

9 CAN Layer 2 Mode

10 Command Interface

27

Shows the reference.

The "→" mark indicates a reference destination and reference manual.

The above is different from the actual page, as it is provided for explanation only.

1. Introduction

1.1 Outline

The FX3U-CAN communication block is an interface block that allows FX3G/FX3GC/FX3U/FX3UC/FX5U/FX5UC PLCs to connect to a CANopen[®] system. FX3U-CAN can be connected directly to the FX3G/FX3GC^{*1}/FX3U/FX3UC^{*1}/FX5U^{*2}/FX5UC^{*2} PLC's extension port, or to any other extension unit / block's right side extension port.

- *1. An FX2NC-CNV-IF or FX3UC-1PS-5V is necessary to connect the FX3U-CAN to an FX3GC/FX3UC Series PLC.
- *2. An FX5-CNV-BUS or FX5-CNV-BUSC is necessary to connect the FX3U-CAN to an FX5U/FX5UC PLC.

For safe use



- This product has been manufactured as a general-purpose part for general industries, and has not been designed or manufactured to be incorporated in a device or system used in purposes related to human life.
- Before using the product for special purposes such as nuclear power, electric power, aerospace, medicine or passenger movement vehicles, consult with Mitsubishi Electric.
- This product has been manufactured under strict quality control. However when installing the product where major accidents or losses could occur if the product fails, install appropriate backup or failsafe functions in the system.

1.1.1 Overview of the CANopen[®] Network

CANopen[®] is a CAN based higher layer protocol which provides a very flexible system for transferring serial messages between different nodes via the CAN bus.

- 1) Simple, relatively high speed communication can be accomplished with modules that handle binary data such as I/Os or numeric data.
- 2) All CANopen[®] nodes are able to transmit data and several nodes can make a request to the CAN bus simultaneously.
- 3) Messages can be prioritized for transfer to the CAN Bus.

1

Introduction

2

Specifications

3

Installation

4

Wiring

5

Introduction of Functions

6

Allocation of Buffer Memories

7

Interface and Device Profile (405 mode)

8

Lift Application Profile (417 Mode)

9

CAN Layer 2 Mode

10

Command Interface

1.1.2 Overview of FX3U-CAN communication block

CANopen[®] ready I/O stations and device stations can be connected to the CAN bus and information can be transmitted to the FX3U-CAN communication block and FX3G/FX3GC/FX3U/FX3UC/FX5U/FX5UC PLC.

1. The maximum send / receive message number

80 TPDO /80 RPDO (8 bytes / PDO) can be sent and received to/from a CANopen[®] network.

2. CANopen[®] device/application Profiles according to CiA[®] Standards

- Interface and Device Profile CiA[®] 405 V2.0 for IEC 61131-3 Programmable Devices.
- Application Profile CiA[®] 417 V2.1 for lift control systems.

3. Communication with other CANopen[®] nodes

All nodes on the CANopen[®] network can write data to all the other nodes on the network. Each piece of data has a unique identifying number that is read by the receiving nodes to determine whether that data should be kept in the receiving nodes' Buffer Memory.

The FX3U-CAN communication block uses buffer memories to communicate on the CAN bus. Each buffer memory is separated into memory dedicated to write TO and memory dedicated to read FROM the CAN bus. These Buffer Memories are accessed by FROM/TO commands of the PLC. However, only FX3U/FX3UC/FX5U/FX5UC PLC supports direct specification of the buffer memory.

For further information on applied instructions, bit specification of word devices and direct specification of buffer memory, refer to the following manual.

→ Refer to PROGRAMMING MANUAL

Note

Buffer memory that is assigned in 32 bits must use 32-bit instructions to read/write.

32-bit data cannot be correctly read/written from/to buffer memory if 16-bit read/write instructions are used.

1.1.3 Characteristics

This section describes the characteristics of the CAN bus, communication with other CANopen[®] nodes, and some of the special features available in the CANopen[®] protocol.

1. The object dictionary

The Object Dictionary is a type of indexed storage system that contains data, device parameters, CANopen[®] feature setup data, instruction triggers, and other information necessary to configure and operate the CANopen[®] protocol.

2. SDO command

The Service Data Object Command can be used to read/write data to the Object Dictionary.

This command can be used to set network parameters and also to initiate CANopen[®] functionality.

3. SYNC service

The SYNC service provides the basic network synchronization mechanism.

4. TIME service

The TIME service provides a simple network clock. CANopen[®] devices that operate a local clock may use the TIME object to adjust their own time base to that of the time stamp object producer.

5. EMCY object service

Emergency objects are triggered by the occurrence of a CANopen[®] device internal error situation and are transmitted from an emergency producer on the CANopen[®] device.

6. Network management (hereinafter called NMT)

- General NMT services
- Node guarding Master/Slave
- Heartbeat Consumer/Producer

7. The command interface

The Command Interface (CIF) can be used to access the Object Dictionary of the local node or a network node and is located in the BFM. Access is performed by commands for SDO read/write, special direct command for Node Guarding, Heartbeat, PDO Mapping or Emergency Messages.

8. NMT master

The network management provides services for controlling the network behaviour of CANopen[®] devices as defined in CiA[®] 301 and CiA[®] 302. All CANopen[®] devices of a network referred to as NMT slaves are controlled by services provided by an NMT master.

9. Flying master

The flying master mechanism provides services for a hot stand-by NMT master within a CANopen[®] network.

10. Configuration manager

The Configuration manager provides mechanisms for configuration of CANopen[®] devices in a CANopen[®] network.

11. SYNC producer

The SYNC producer broadcasts the SYNC object. The SYNC service provides the basic network synchronization mechanism.

12. Layer setting services master (hereinafter called LSS) according to standard CiA[®] 305 V2.2

With this service, an LSS slave device that is sealed against harsh environments and that does not have any hardware components like DIP-switches for setting the node-ID or bit timing parameters can be configured via the CAN Bus.

13. MPDO for Lift Application Profile

An MPDO provides direct write access to objects of a CANopen device's object dictionary. The size of the data of these objects is limited to a maximum of 4 bytes.

1

Introduction

2

Specifications

3

Installation

4

Wiring

5

Introduction of Functions

6

Allocation of Buffer Memories

7

Interface and Device Profile (405 mode)

8

Lift Application Profile (417 Mode)

9

CAN Layer 2 Mode

10

Command Interface

1.2 External Dimensions and Each Part Name

1.2.1 External dimensions and each part name

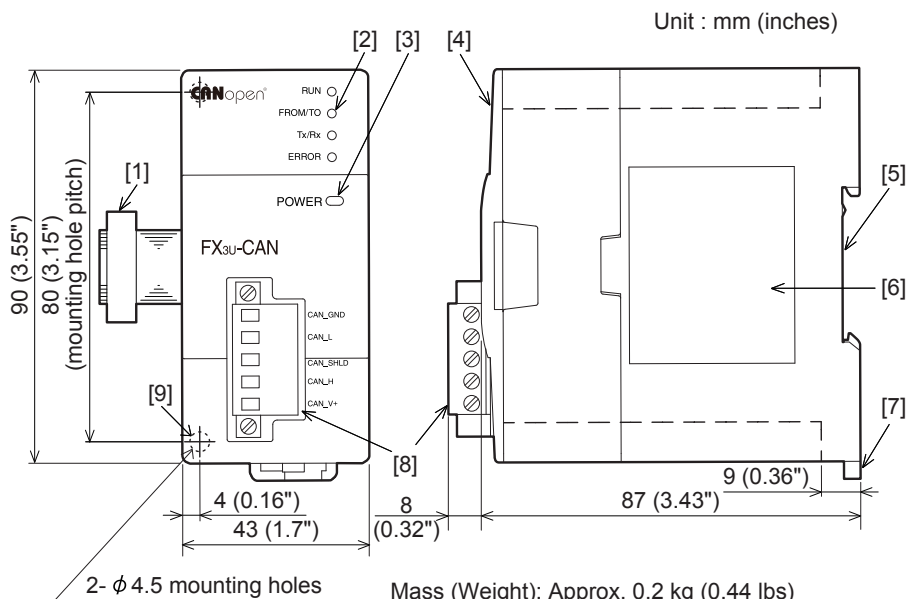

Mass (Weight): Approx. 0.2 kg (0.44 lbs)

Accessories: Label for indication of special function unit/block number,
Dust proof protection sheet,
Terminating resistor (120 Ω 1/2W),
Manual supplied with product

- | | |
|---|---|
| [1] Extension cable | [6] Nameplate |
| [2] Status LEDs (See Subsection 1.2.2) | [7] DIN rail mounting hook |
| [3] Power LED (See Subsection 1.2.2) | [8] CAN bus connector |
| [4] Top cover | [9] Direct mounting hole
2 holes of ϕ 4.5 (0.18")
(mounting screw: M4 screw) |
| [5] DIN rail mounting groove
DIN rail: DIN46277, 35 mm (1.38") width | |

1.2.2 Power and status LEDs

LED Name	LED Color	Status	Description
RUN	Green	OFF	Layer 2 offline mode
		SINGLE FLASH* ¹	CANopen® STOPPED state
		BLINKING* ¹	CANopen® PRE-OPERATIONAL state
		FLICKERING* ¹	LSS Services in progress
		ON	<ul style="list-style-type: none"> CANopen® mode: CANopen® OPERATIONAL state Layer 2 mode: Layer 2 online mode
FROM/TO	Green	OFF	PLC is not accessing BFM's in module.
		ON	PLC is accessing BFM's in module.
Tx/Rx	Green	OFF	Module is not transmitting or receiving CAN messages.
		ON	Module is transmitting or receiving CAN messages.
ERROR	Red	OFF	No error
		SINGLE FLASH* ¹	At least one of the error counters of the module has reached or exceeded the error passive level.
		DOUBLE FLASH* ¹	A NMT guarding failure (NMT-Slave or NMT-Master) or a heartbeat failure has occurred.
		BLINKING* ¹	General error
		FLICKERING* ¹	LSS Services in progress
		ON	Module is BUS-OFF state, or CPU error occurs in PLC main unit.
POWER	Green	ON	24V DC power is properly supplied from PLC main unit.

*1. RUN and ERROR LEDs have four kinds of flicker states: single flash, double flash, blinking, and flickering.
This LED flickers as follows.

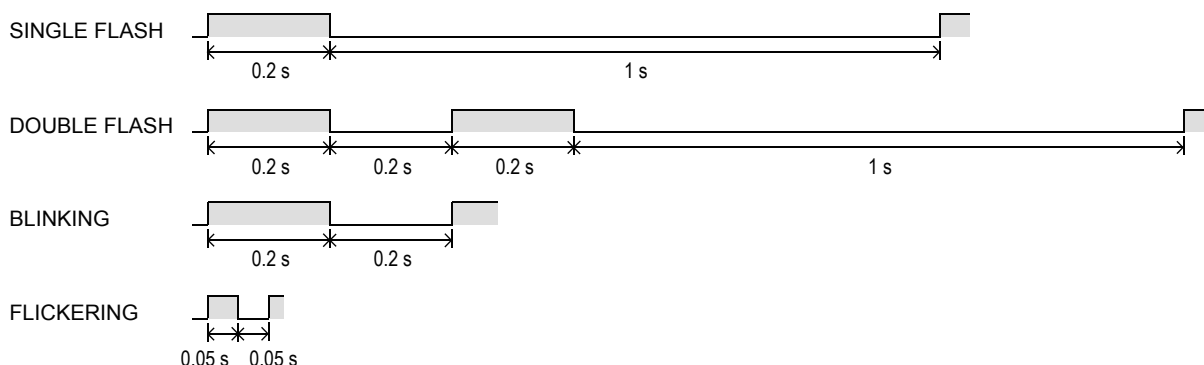

1.2.3 Terminal layout

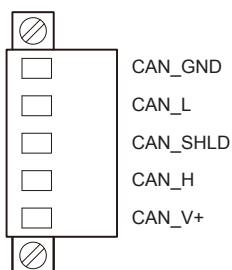

Pin No.	Signal	Description
1	CAN_GND	Ground / 0 V / V-
2	CAN_L	CAN_L bus line (dominant low)
3	(CAN_SHLD)	Optional CAN shield
4	CAN_H	CAN_H bus line (dominant high)
5	(CAN_V+)	Optional CAN external positive supply (not connected internally)

- 1 Introduction
- 2 Specifications
- 3 Installation
- 4 Wiring
- 5 Introduction of Functions
- 6 Allocation of Buffer Memories
- 7 Interface and Device Profile (405 mode)
- 8 Lift Application Profile (417 Mode)
- 9 CAN Layer 2 Mode
- 10 Command Interface

1.3 System Configuration

1.3.1 General configuration

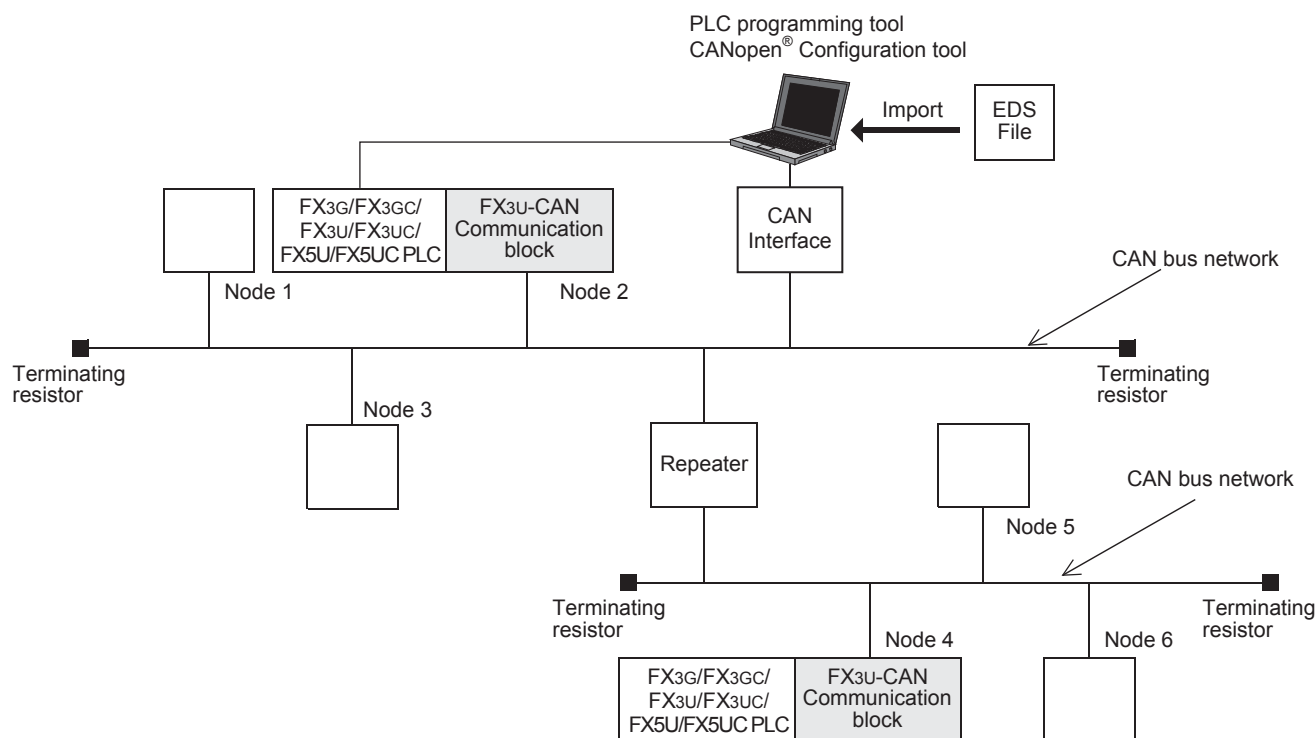

Part Name	Model Name	Remarks
Communication block	FX3U-CAN	
PLC	FX3G/FX3GC/FX3U/ FX3UC/FX5U/FX5UC PLC	An FX2NC-CNV-IF or FX3UC-1PS-5V is necessary to connect the FX3U-CAN to an FX3GC/FX3UC Series PLC. An FX5-CNV-BUS or FX5-CNV-BUSC is necessary to connect the FX3U-CAN to an FX5U/FX5UC PLC.
CAN bus network	-	CAN bus network
Node	-	CANopen® Node, or CAN Layer 2 Node
Repeater	-	
CANopen® Configuration tool	-	
PLC programming tool	GX Works2	
EDS file (Electronic Data Sheet file)	FX3U-CAN-405.eds, FX3U-CAN-417.eds	FX3U-CAN-405: When using FX3U-CAN by Interface and Device Profile CiA® 405 for IEC 61131-3 Programmable Devices, the EDS file uses FX3U-CAN-405.eds. FX3U-CAN-417: When using FX3U-CAN by Application Profile CiA® 417 for lift control systems, the EDS file uses FX3U-CAN-417.eds.
CAN Interface	-	Hardware Interface between CANopen® Configuration tool and CAN bus.
Terminating resistor	-	The CAN bus network requires terminating resistors for network both ends.
Maximum transmission distance	-	5000 m (16,404'2") at 10 kbps (with repeaters). The transmission distance is reduced to 25 m (82') at the maximum baud rate of 1 Mbps. The maximum distance also depends on the specification of other connected nodes.

How to obtain EDS file

For EDS file, consult with your local Mitsubishi Electric representative.

1.3.2 Applicable PLC

Model name	Applicability
FX3G Series PLC	Ver. 1.00 and later (Up to 8 blocks can be extended ^{*2})
FX3GC Series PLC ^{*1}	Ver. 1.40 and later (Up to 8 blocks can be extended ^{*2})
FX3U Series PLC	Ver. 2.20 and later (Up to 8 blocks can be extended ^{*2})
FX3UC Series PLC ^{*1}	Ver. 2.20 and later (Up to 8 blocks can be extended ^{*2*3})
FX5U PLC ^{*4*5}	Ver. 1.031 and later (Up to 8 blocks can be extended ^{*2})
FX5UC PLC ^{*4*5}	Ver. 1.031 and later (Up to 8 blocks can be extended ^{*2})

The version number can be checked by reading the last three digits of device D8001/D8101.

- *1. An FX2NC-CNV-IF or FX3UC-1PS-5V is necessary to connect the FX3U-CAN to an FX3GC/FX3UC PLC.
- *2. Check the current consumption of the connected extension blocks and when necessary insert extension power supply units.
- *3. Up to 7 units can be connected to the FX3UC-32MT-LT(-2) PLC.
- *4. An FX5-CNV-BUS or FX5-CNV-BUSC is necessary to connect the FX3U-CAN to an FX5U/FX5UC PLC.
- *5. Applicable for FX3U-CAN firmware Ver. 1.12 and later.

1

Introduction

2

Specifications

3

Installation

4

Wiring

5

Introduction of Functions

6

Allocation of Buffer Memories

7

Interface and Device Profile (405 mode)

8

Lift Application Profile (417 Mode)

9

CAN Layer 2 Mode

10

Command Interface

1.3.3 Connection with PLC

The FX3U-CAN connects with a PLC via an extension cable.

The FX3U-CAN is handled as a special extension block of the PLC. The unit number of the FX3U-CAN is automatically assigned No. 0 to No. 7*1*2 starting from the special function unit/block closest to the PLC main unit/CPU Module.

(This unit number is used for the designation of a FROM/TO instruction.)

For further information of the assignment of the I/O number and unit number of the PLC, refer to the following manual corresponding to the connected PLC.

*1. Unit No. 1 to No. 7 is assigned when the main unit is an FX3UC-32MT-LT(-2).

*2. Unit No. 2 to No. 16 is assigned when the CPU module is an FX5U/FX5UC.

→ Refer to **FX3G Hardware Edition**

→ Refer to **FX3GC Hardware Edition**

→ Refer to **FX3U Hardware Edition**

→ Refer to **FX3UC Hardware Edition**

→ Refer to **MELSEC iQ-F FX5U User's Manual (Hardware)**

→ Refer to **MELSEC iQ-F FX5UC User's Manual (Hardware)**

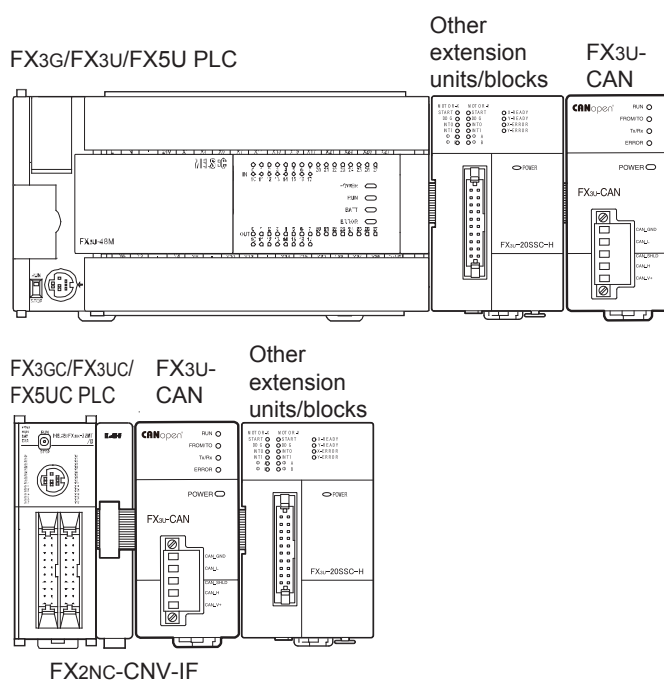

- An FX2NC-CNV-IF or FX3UC-1PS-5V is necessary to connect the FX3U-CAN to an FX3GC/FX3UC PLC.
- An FX5-CNV-BUS or FX5-CNV-BUSC is necessary to connect the FX3U-CAN to an FX5U/FX5UC PLC.
- The optional FX0N-65EC (FX0N-30EC) and FX2N-CNV-BC are necessary to lengthen the extension cable. (FX3G/FX3GC/FX3U/FX3UC PLC)
- The optional FX5-65EC (FX5-30EC) and FX5-CNV-BC are necessary to lengthen the extension cable. (FX5U/FX5UC PLC)
- The number of I/O points occupied by the FX3U-CAN is eight. Make sure that the total number of I/O points (occupied I/O points) of the main unit, extension unit(s), extension block(s) and the number of points occupied by special function blocks does not exceed the maximum number of I/O points of the PLC.

For further information of the maximum number of I/O points of the PLC, refer to the respective product manual.

→ Refer to **FX3G Hardware Edition**

→ Refer to **FX3GC Hardware Edition**

→ Refer to **FX3U Hardware Edition**

→ Refer to **FX3UC Hardware Edition**

→ Refer to **MELSEC iQ-F FX5U User's Manual (Hardware)**

→ Refer to **MELSEC iQ-F FX5UC User's Manual (Hardware)**

1.4 System Start-up Procedure

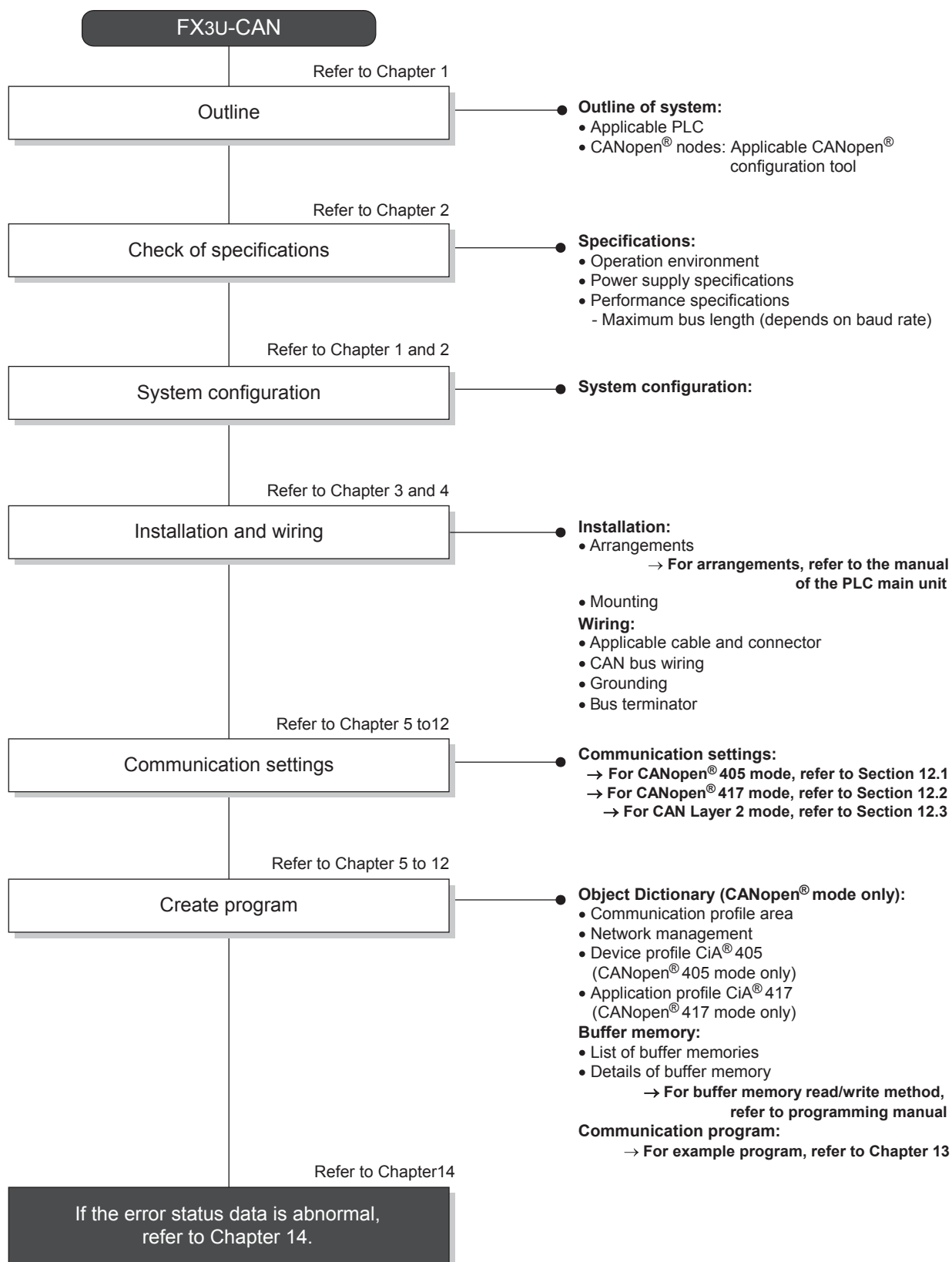

1	Introduction
2	Specifications
3	Installation
4	Wiring
5	Introduction of Functions
6	Allocation of Buffer Memories
7	Interface and Device Profile (405 mode)
8	Lift Application Profile (417 Mode)
9	CAN Layer 2 Mode
10	Command Interface

2. Specifications

DESIGN PRECAUTIONS



WARNING

- Make sure to have the following safety circuits outside of the PLC to ensure safe system operation even during external power supply problems or PLC failure. Otherwise, malfunctions may cause serious accidents.
 - 1) Most importantly, have the following: an emergency stop circuit, a protection circuit, an interlock circuit for opposite movements (such as normal vs. reverse rotation), and an interlock circuit (to prevent damage to the equipment at the upper and lower positioning limits).
 - 2) Note that when the PLC CPU detects an error, such as a watchdog timer error, during self-diagnosis, all outputs are turned off. Also, when an error that cannot be detected by the PLC CPU occurs in an input/output control block, output control may be disabled. External circuits and mechanisms should be designed to ensure safe machinery operation in such a case.
- For the operating status of each node in the case of a communication error, see the FX3U-CAN user's manual and the product manual of each node. Erroneous output or malfunctions may cause an accident.
- When executing control (data changes) to an operating PLC, construct an interlock circuit in the sequence program so that the entire system operates safely. In addition, when executing control such as program changes and operation status changes (status control) to an operating PLC, carefully read the manual and sufficiently confirm safety in advance. Especially in control from external equipment to a PLC in a remote place, problems in the PLC may not be able to be handled promptly due to abnormality in data transfer. Construct an interlock circuit in the sequence program. At the same time, determine the actions in the system between the external equipment and the PLC for protection against abnormalities in data transfer.

DESIGN PRECAUTIONS



CAUTION

- Make sure to observe the following precautions in order to prevent any damage to the machinery or accidents due to abnormal data written to the PLC under the influence of noise:
 - 1) Do not bundle the main circuit line together with or lay it close to the main circuit, high-voltage line or load line. Otherwise, noise disturbance and/or surge induction are likely to take place. As a guideline, lay the control line at least 100mm (3.94") or more away from the main circuit or high-voltage lines.
 - 2) Ground the shield wire or shield of a shielded cable. Do not use common grounding with heavy electrical systems (refer to the manual of the PLC main unit).

DISPOSAL PRECAUTIONS



CAUTION

- Please contact a certified electronic waste disposal company for the environmentally safe recycling and disposal of your device.

TRANSPORTATION AND STORAGE PRECAUTIONS



CAUTION

- The PLC is a precision instrument. During transportation, avoid impacts larger than those specified in the general specifications of the PLC main unit manual by using dedicated packaging boxes and shock-absorbing palettes. Failure to do so may cause failures in the PLC. After transportation, verify operation of the PLC and check for damage of the mounting part, etc.

2.1 General Specifications

Items other than the following table are equivalent to those of the PLC main unit/CPU Module.
For further information of general specifications, refer to the manual of the PLC main unit/CPU Module.

- Refer to FX3G Hardware Edition
- Refer to FX3GC Hardware Edition
- Refer to FX3U Hardware Edition
- Refer to FX3UC Hardware Edition
- Refer to MELSEC iQ-F FX5U User's Manual (Hardware)
- Refer to MELSEC iQ-F FX5UC User's Manual (Hardware)

Item	Specification	
Dielectric Withstand Voltage	500V AC for one minute	Between all terminals and ground terminal
Insulation Resistance	5MΩ or higher by 500V DC insulation resistance tester	

2.2 Power Supply Specifications

Item	Specification
Internal Power Supply	24V DC, max 110 mA 24V DC power is supplied internally from the main unit.

For details on the 24V DC power supply of main unit, refer to the manual of the PLC main unit.

2.3 Performance Specifications

Item	Specification
Transmission Type	CAN Bus network (RS-485, CSMA/CR)
Applicable Function	CANopen [®] Node, CAN Layer 2 Node
CANopen [®] Communication Services According to CiA [®] Standards	CiA [®] 301 V4.2 CiA [®] 302 V4.1 CiA [®] 305 V2.2
CANopen [®] Device and Application Profiles According to CiA [®] Standards	<ul style="list-style-type: none"> • Interface and Device Profile CiA[®] 405 V2.0 for IEC 61131-3 Programmable Devices. • Application Profile CiA[®] 417 V2.1 for lift control systems.
Remote Transmit Request (RTR)	No support in CANopen [®] mode. Support in Layer 2 mode. → For support in Layer 2 mode, refer to Chapter 9
Node Number on CANopen [®] Network	Maximum 127 nodes A total of 30 nodes can be connected to any segment of the bus. Using repeaters or bridges, the total number can be extended up to 127 nodes.
Node ID	Selectable from 1 to 127
Communication Method	Acyclic, cyclic or event driven
Supported Transmission Speed / Maximum Bus Length	1 Mbps / 25 m (82')
	800 kbps / 50 m (164')
	500 kbps / 100 m (328'1")
	250 kbps / 250 m (820'2")
	125 kbps / 500 m (1640'5")
	100 kbps / 600 m (1968'6")
	50 kbps / 1000 m (3280'10")
	20 kbps / 2500 m (8202'1")
10 kbps / 5000 m (16404'2")	
Connection Cable	Refer to Subsection 4.1.2.
Terminating Resistor	120 Ω (Accessory: 120 Ω 1/2W)
No. of Occupied I/O Points	8 points (taken from either the input or output points of the PLC)

1

Introduction

2

Specifications

3

Installation

4

Wiring

5

Introduction of Functions

6

Allocation of Buffer Memories

7

Interface and Device Profile (405 Mode)

8

Lift Application Profile (417 Mode)

9

CAN Layer 2 Mode

10

Command Interface

3. Installation

INSTALLATION PRECAUTIONS



WARNING

- Make sure to cut off all phases of the power supply externally before attempting installation or wiring work. Failure to do so may cause electric shock or damage to the product.

INSTALLATION PRECAUTIONS



CAUTION

- Use the product within the generic environment specifications described in PLC main unit manual (Hardware Edition). Never use the product in areas with excessive dust, oily smoke, conductive dusts, corrosive gas (salt air, Cl₂, H₂S, SO₂ or NO₂), flammable gas, vibration or impacts, or expose it to high temperature, condensation, or rain and wind. If the product is used in such conditions, electric shock, fire, malfunctions, deterioration or damage may occur.
- Do not touch the conductive parts of the product directly. Doing so may cause device failures or malfunctions.
- When drilling screw holes or wiring, make sure that cutting and wiring debris do not enter the ventilation slits. Failure to do so may cause fire, equipment failures or malfunctions.
- Be sure to remove the dust proof sheet from the PLC's ventilation port when installation work is completed. Failure to do so may cause fire, equipment failures or malfunctions.
- Install the product on a flat surface. If the mounting surface is rough, undue force will be applied to the PC board, thereby causing nonconformities.
- Install the product securely using a DIN rail or mounting screws.
- Connect extension cables securely to their designated connectors. Loose connections may cause malfunctions.

3.1 Connection with PLC

The FX3U-CAN connects on the right side of a PLC main unit/CPU Module or extension units/blocks (including special function units/blocks).

For connection to an FX3GC/FX3UC Series PLC or FX2NC Series PLC extension block, an FX2NC-CNV-IF or FX3UC-1PS-5V is required.

For connection to an FX5U/FX5UC PLC, an FX5-CNV-BUS or FX5-CNV-BUSC is required.

For further information, refer to the respective PLC manual.

→ Refer to FX3G Hardware Edition

→ Refer to FX3GC Hardware Edition

→ Refer to FX3U Hardware Edition

→ Refer to FX3UC Hardware Edition

→ Refer to MELSEC iQ-F FX5U User's Manual (Hardware)

→ Refer to MELSEC iQ-F FX5UC User's Manual (Hardware)

3.2 Mounting

The FX3U-CAN may be installed in a control cabinet with a 35 mm wide DIN46277 DIN rail mounting or M4 screw direct mounting.

3.2.1 DIN rail mounting

The product may be mounted on a 35 mm wide DIN46277 (DIN rail).

1 Fit the upper edge (A in the figure to the right) of the DIN rail mounting groove onto the DIN rail.

2 Push the product onto the DIN rail.

- An interval space of 1 to 2 mm (0.04" to 0.08") between each unit is necessary.

3 Connect the extension cable.

Connect the extension cable (B in the figure to the right) to the main unit, I/O extension unit/block or special function unit/block on the left side of the product.

For further information of the extension cable connection procedure, refer to the respective product PLC manual.

- Refer to FX3G Hardware Edition
- Refer to FX3GC Hardware Edition
- Refer to FX3U Hardware Edition
- Refer to FX3UC Hardware Edition
- Refer to MELSEC iQ-F FX5U User's Manual (Hardware)
- Refer to MELSEC iQ-F FX5UC User's Manual (Hardware)

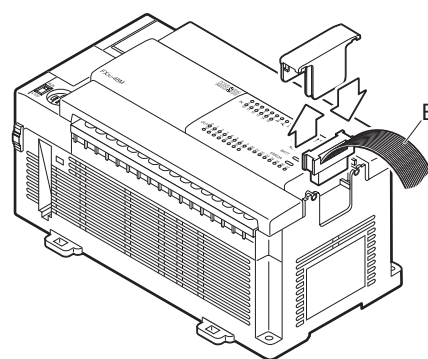
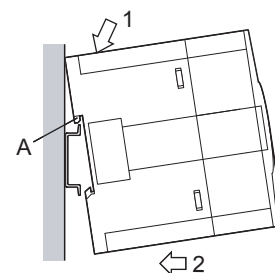

- Example of installation on DIN rail
 - In the case of the FX3G/FX3U PLC

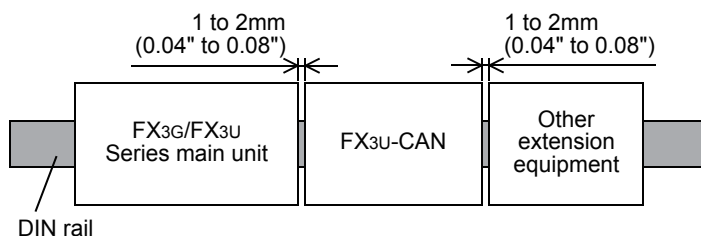

- In the case of the FX3GC/FX3UC PLC

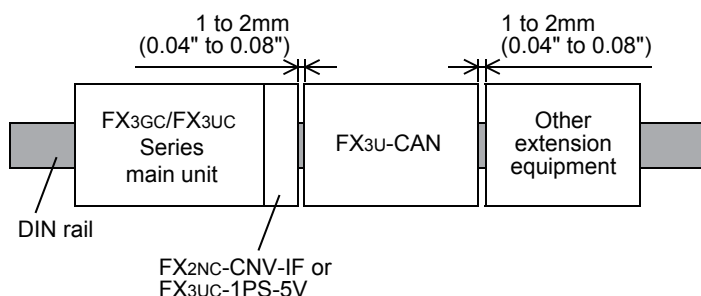

1

Introduction

2

Specifications

3

Installation

4

Wiring

5

Introduction of Functions

6

Allocation of Buffer Memories

7

Interface and Device Profile (405 Mode)

8

Lift Application Profile (417 Mode)

9

CAN Layer 2 Mode

10

Command Interface

3.2.2 Direct Mounting

The product can be installed directly with screws.
An interval space of 1 to 2 mm (0.04" to 0.08") between each unit is necessary.
For further information of installation, refer to the following respective PLC manual.

- For mounting hole pitches, refer to Section 1.2
 - Refer to FX3G Hardware Edition
 - Refer to FX3GC Hardware Edition
 - Refer to FX3U Hardware Edition
 - Refer to FX3UC Hardware Edition
- Refer to MELSEC iQ-F FX5U User's Manual (Hardware)
- Refer to MELSEC iQ-F FX5UC User's Manual (Hardware)

1 Create mounting holes in the mounting surface according to the external dimensions diagram.

2 Fit the FX3U-CAN (A in the figure to the right) to the mounting holes and tighten with M4 screws (B in the figure to the right).

For further information of the screw position and quantity, refer to the dimensioned drawing specified below.
→ For dimensions, refer to Section 1.2

3 Connect the extension cable.

Connect the extension cable to the main unit, I/O extension unit/block or special function unit/block on the left side of the product.

(Refer to Step 3 in Subsection 3.2.1.)

For further information of the extension cable connection procedure, refer to the respective PLC manual.

- Refer to FX3G Hardware Edition
- Refer to FX3GC Hardware Edition
- Refer to FX3U Hardware Edition
- Refer to FX3UC Hardware Edition
- Refer to MELSEC iQ-F FX5U User's Manual (Hardware)
- Refer to MELSEC iQ-F FX5UC User's Manual (Hardware)

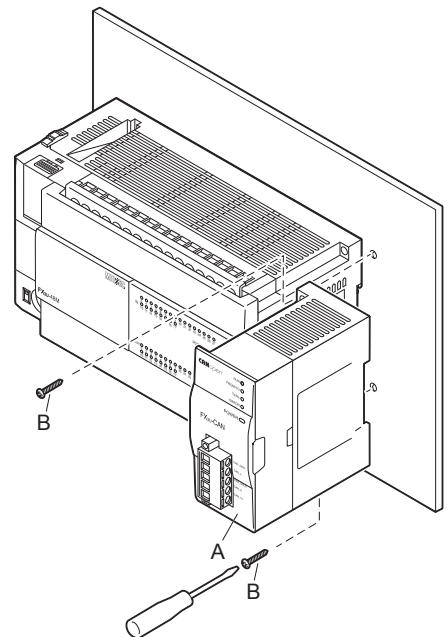

- Example of direct installation

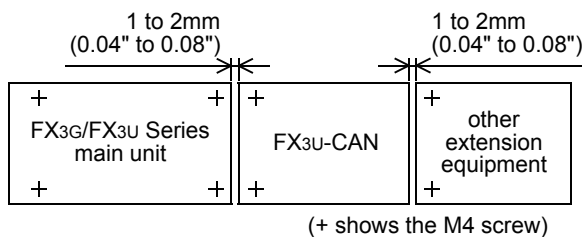

4. Wiring

WIRING PRECAUTIONS



WARNING

- Make sure to cut off all phases of the power supply externally before attempting installation or wiring work. Failure to do so may cause electric shock or damage to the product.

WIRING PRECAUTIONS



CAUTION

- Perform class D grounding (grounding resistance: 100Ω or less) to the shield of the twisted shield cable (refer to Subsection 4.2.3). Do not use common grounding with heavy electrical systems.
- When drilling screw holes or wiring, make sure cutting or wire debris does not enter the ventilation slits. Failure to do so may cause fire, equipment failures or malfunctions.
- Install module so that excessive force will not be applied to communication connectors or communication cables. Failure to do so may result in wire damage/breakage or PLC failure.
- Make sure to affix the CAN bus connector with fixing screws. Tightening torque should follow the specifications in the manual. Loose connections may cause malfunctions.
- Make sure to properly wire to the terminal block (CAN bus connector) in accordance with the following precautions. Failure to do so may cause electric shock, equipment failures, a short-circuit, wire breakage, malfunctions, or damage to the product.
 - The disposal size of the cable end should follow the dimensions described in the manual.
 - Tightening torque should follow the specifications in the manual.
 - Twist the end of strand wire and make sure that there are no loose wires.
 - Do not solder-plate the electric wire ends.
 - Do not connect more than the specified number of wires or electric wires of unspecified size.
 - Affix the electric wires so that neither the terminal block nor the connected parts are directly stressed.
- Make sure to observe the following precautions in order to prevent any damage to the machinery or accidents due to abnormal data written to the PLC under the influence of noise:
 - 1) Do not bundle the main circuit line together with or lay it close to the main circuit, high-voltage line or load line. Otherwise, noise disturbance and/or surge induction are likely to take place. As a guideline, lay the control line at least 100 mm (3.94") or more away from the main circuit or high-voltage lines.
 - 2) Ground the shield wire or shield of a shielded cable. Do not use common grounding with heavy electrical systems.
- Place the communication cable in grounded metallic ducts or conduits both inside and outside of the control panel whenever possible.

4.1 Applicable Cable and Connector

4.1.1 Applicable connector

FX3U-CAN uses a CAN bus connector. This connector is removable.

For further information of removal and installation of the CAN bus connector, refer to the following section.

→ Refer to Subsection 4.1.4

1

Introduction

2

Specifications

3

Installation

4

Wiring

5

Introduction of Functions

6

Allocation of Buffer Memories

7

Interface and Device Profile (405 mode)

8

Lift Application Profile (417 Mode)

9

CAN Layer 2 Mode

10

Command Interface

4.1.2 Applicable cable

Item	Applicable Cable
Cable Type	Twisted pair cable
Unshielded/ Shielded	Shielded
No. of Pairs	2 pair
Conformance Standard	ISO 11898/1993
Wire Size	0.3 mm ² to 0.82 mm ² (AWG22 to 18)
Impedance	120 Ω

Note

The bus length, length related resistance and the cross section of the cable to be used should be related as follows.

Guidelines for the cable are available in CiA[®] 303.

→ For details, refer to CiA[®] 303

Bus Length (m)	Length Related Resistance (mΩ/m)	Cross Section (mm ²)
0 to 40	70	0.3 to 0.34 (AWG 22)
40 to 300	Less than 60	0.34 to 0.60 (AWG 22 to 19)
300 to 600	Less than 40	0.50 to 0.60 (AWG 20 to 19)
600 to 1000	Less than 26	0.75 to 0.80 (AWG 18)

4.1.3 Termination of cable end

Strip 9 mm (0.35") of insulation from the end of the wire. For stranded wires, terminate the end of the wire using a wire ferrule with insulating sleeve.

Tighten the terminals to a torque of 0.4 to 0.5 N•m.

Do not tighten terminal screws with a torque outside the above-mentioned range. Failure to do so may cause equipment failures or malfunctions.

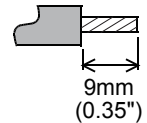

- When using stranded wires

It may be difficult to insert the electric wire into the insulating sleeve depending on the thickness of the electric wire sheath. Select appropriate electric wire by referring to the dimensions of the wire ferrule.

<Reference>

Manufacturer	Model names	Caulking tool
Phoenix Contact	AI 0.5-8WH	CRIMPFOX 6 ^{*1} (or CRIMPFOX 6T-F ^{*2})
	AI-TWIN 2X 0.5-8WH	

*1. Old model name : CRIMPFOX ZA 3

*2. Old model name : CRIMPFOX UD 6

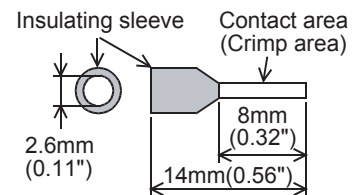

4.1.4 Removal and installation of CAN bus connector

- 1) Removal

Evenly unscrew both CAN connector mounting screws, and remove the CAN connector from the module. If the cable is attached to the connector, hold and pull the connector on the side. Do not pull the cable.

- 2) Installation

Place the CAN connector in the specified position, and evenly tighten both CAN connector mounting screws.

Tightening torque 0.4 to 0.5 N•m

Do not tighten the terminal block mounting screws with a torque outside the above-mentioned range.

Failure to do so may cause equipment failures or malfunctions.

4.2 CAN-Bus Wiring

4.2.1 Connecting communication cables

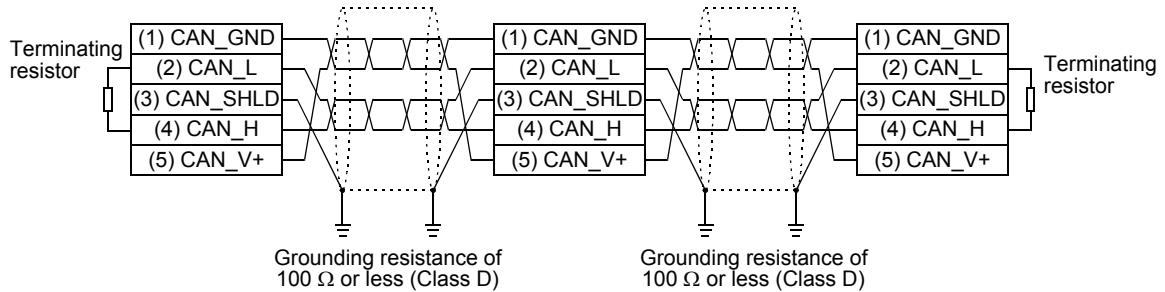

For electromagnetic compatibility (EMC), it is recommended to ground the cable shield at both ends.

Caution

For safety, always check the potential differences between the grounding points. If potential differences are found, proper measures must be taken to avoid damage.

4.2.2 Module wiring

For further information on PLC wiring, refer to the following manual.

- Refer to FX3G Hardware Edition
- Refer to FX3GC Hardware Edition
- Refer to FX3U Hardware Edition
- Refer to FX3UC Hardware Edition
- Refer to MELSEC iQ-F FX5U User's Manual (Hardware)
- Refer to MELSEC iQ-F FX5UC User's Manual (Hardware)

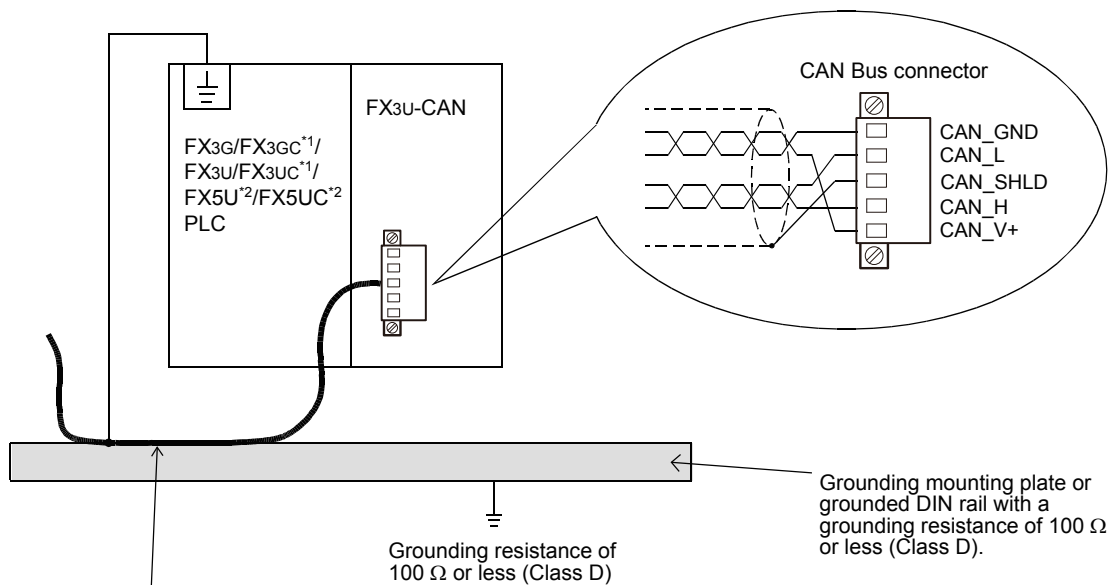

Strip a part of the coating of the shielded twisted pair cable as shown in subsection 4.2.3. Ground the PLC's grounding terminal there.

- *1. An FX2NC-CNV-IF or FX3UC-1PS-5V is necessary to connect the FX3U-CAN to an FX3GC/FX3UC Series PLC.
- *2. An FX5-CNV-BUS or FX5-CNV-BUSC is necessary to connect the FX3U-CAN to an FX5U/FX5UC PLC.

1	Introduction
2	Specifications
3	Installation
4	Wiring
5	Introduction of Functions
6	Allocation of Buffer Memories
7	Interface and Device Profile (405 Mode)
8	Lift Application Profile (417 Mode)
9	CAN Layer 2 Mode
10	Command Interface

4.2.3 Grounding of twisted pair cable

Strip a part of the coating of the shielded twisted pair cable as shown below, and ground at least 35 mm (1.38") of the exposed shield section.

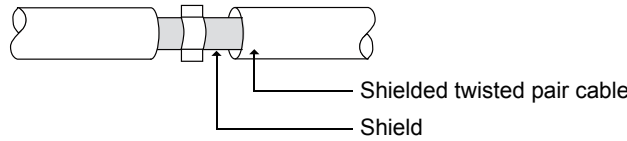

4.2.4 Termination

The CANopen® network requires terminating resistors for both network ends. When FX3U-CAN is the network end, connect the included terminating resistor (120 Ω 1/2W) between pin number 2 (CAN_L) and 4 (CAN_H).

4.3 Grounding

Ground the cables as follows

- The grounding resistance should be 100 Ω or less.
- Independent grounding should be established whenever possible. Independent grounding should be performed for best results. When independent grounding is not configured, perform "shared grounding" as shown in the following figure. For further information, refer to the respective PLC manual.

- Refer to FX3G Hardware Edition
- Refer to FX3GC Hardware Edition
- Refer to FX3U Hardware Edition
- Refer to FX3UC Hardware Edition
- Refer to MELSEC iQ-F FX5U User's Manual (Hardware)
- Refer to MELSEC iQ-F FX5UC User's Manual (Hardware)

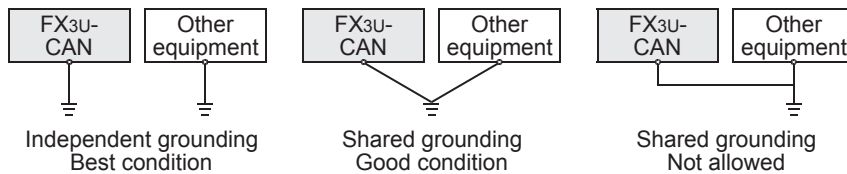

- The grounding point should be close to the FX3U-CAN, and all grounding wires should be as short as possible.

5. Introduction of Functions

5.1 Functions List

The function list is shown below.

Functions	Description	Reference
Function Modes	Different Function Modes of the module	Section 5.2 and Section 6.5
Object Dictionary	Link between CANopen® network and PLC	Section 5.3
Command Interface	Module Interface to the Object Dictionary	Section 5.4 and Chapter 10
SDO	Service Data Object	Subsection 5.6.4
RPDO / TPDO	Receive/Transmit Process Data Object	Subsection 5.6.5
MPDO	Multiplexed Process Data Object	Subsection 5.6.6
SYNC	Synchronization object	Subsection 5.6.7
Node guarding	Node guarding service	Subsection 5.6.8
Heartbeat	Heartbeat Service	Subsection 5.6.9
TIME	Time stamp object	Subsection 5.6.10
EMCY	Emergency object	Subsection 5.6.13
General NMT	General Network management services	Section 5.8
NMT Master	Network Management Master Services	Section 5.8
Boot-Up	Device Boot-Up Message Service	Subsection 5.8.2
Flying Master	Flexible Network Management	Subsection 5.8.11
LSS	Layer Setting Service for Devices	Subsection 5.8.12
Configuration manager	Mechanism for configuration of the Object Dictionary of other CANopen® Devices	Subsection 5.8.13
Profile CiA® 405 V2.0	Device Profile for IEC 61131-3 Programmable Devices	Section 5.9 and Chapter 7
Profile CiA® 417 V2.1	Application Profile for lift control systems	Section 5.10 and Chapter 8
Layer 2 Message mode	Layer 2 Message transmission and receive Mode	Chapter 9
PLC RUN / STOP	Module behaviour in case of PLC RUN/STOP	Chapter 11

5.2 Function Modes

The FX3U-CAN has four different function modes. The function mode is set up by BFM #21. For further information on how to set the function mode, refer to the following section.

→ Refer to Section 6.5

Function Mode	Description
11 bit CAN-ID Layer 2 mode	This mode supports full access to Layer 2 of the CAN communication protocol. Customized 11-bit Identifier Layer 2 messages can be sent and raw 11-bit Identifier Layer 2 messages can be received.
29 bit CAN-ID Layer 2 mode	This mode supports full access to Layer 2 of the CAN communication protocol. Customized 29-bit Identifier Layer 2 messages can be sent and raw 29-bit Identifier Layer 2 messages can be received.
CANopen® 405 mode	This mode supports the CANopen® CiA® 405 IEC 61131-3 Programmable Device Profile.
CANopen® 417 mode	This mode supports the CANopen® CiA® 417 Lift Application Profile.

- 1 Introduction
- 2 Specifications
- 3 Installation
- 4 Wiring
- 5 Introduction of Functions
- 6 Allocation of Buffer Memories
- 7 Interface and Device Profile (405 mode)
- 8 Lift Application Profile (417 Mode)
- 9 CAN Layer 2 Mode
- 10 Command Interface

5.3 Object Dictionary

The Object Dictionary is a structure for data organization within the CANopen[®] network. The data within the Object Dictionary is used to set CAN bus parameters, initialize special functions, control data flow, store data in many formats and send emergency messages.

The Object Dictionary is structured in Indexes and Sub-Indexes. Each Index addresses a single parameter, a set of parameters, network input/output data or other data. A Sub-Index addresses a subset of the parameter or data of the Index.

General layout of CANopen[®] standard object dictionary

The general layout of the CANopen[®] standard object dictionary is shown below.

Index (hex)	Object
0000	Not used
0001 to 009F	Data type definitions → Refer to Section 5.5
00A0 to 0FFF	Reserved
1000 to 1FFF	Communication profile area (CiA [®] 301/CiA [®] 302) → Refer to Section 5.6 and Section 5.8
2000 to 5FFF	Manufacturer-specific profile area
6000 to 9FFF	Standardized Profile area (CiA [®] 417) → Refer to Section 5.10
A000 to AFFF	Standardized Profile area (CiA [®] 405) → Refer to Section 5.9
B000 to FFFF	Reserved

5.4 Command Interface

The Command Interface (CIF) provides access to the Object Dictionary of the FX3U-CAN and the Object Dictionary of other CANopen[®] nodes in the network. Using the BFM area #1000 to #1066, the various CIF functions can be used for SDO read/write, RPDO and TPDO configuration/mapping, configuration of Node Guarding, Heartbeat, Emergency Messages and others.

→ For Command Interface, refer to Chapter 10

Command Interface	Function Mode Selection				Reference
	Mode 405	Mode 417	Mode 11	Mode 29	
SDO Request	✓	✓	-	-	Section 10.2
Set Heartbeat	✓	✓	-	-	Section 10.3
Set Node Guarding / NMT slave assignment	✓	✓	-	-	Section 10.4
Send an Emergency Message	✓	✓	-	-	Section 10.5
Store Object Dictionary settings	✓	✓	-	-	Section 10.6
Restore Object Dictionary default settings	✓	✓	-	-	Section 10.7
Communication Mapping Modes	✓	-	-	-	Section 7.2
Display current Parameter	✓	✓	✓	✓	Section 10.8
Sending Layer 2 Message	-	-	✓	✓	Section 9.7

5.5 Data Type Definition Area

Static data types are placed in the object dictionary for definition purposes only. Indexes H0002 to H0008 may be mapped in order to define the appropriate space in the RPDO as not being used by the device. An SDO access results in an error.

→ For RPDO, refer to Subsection 5.6.5

Index (hex)	Sub-index (hex)	Object	Description	Data Type
0001	00	Data type definition	Reserved	-
0002	00		Signed 8bit	I8
0003	00		Signed 16bit	I16
0004	00		Signed 32bit	I32
0005	00		Unsigned 8bit	U8
0006	00		Unsigned 16bit	U16
0007	00		Unsigned 32bit	U32
0008	00		Float 32 bit	Real32
0009 to 009F	00		Reserved	-

5.6 Communication Profile Area

The table below provides a brief description and reference information for the FX3U-CAN CANopen® Object Dictionary.

Note: Stored to Flash ROM

Data will be saved in the Flash ROM by using the Store Parameter command in Index H1010. Be careful with write handling. The maximum number of writes to the built-in flash ROM is 10,000 times.

Note

Here, the RPDO and TPDO settings for CANopen® 405 mode are described.

→ For the settings in CANopen® 417 mode, refer to the EDS file

How to obtain EDS files

For EDS files (FX3U-CAN-405.eds, FX3U-CAN-417.eds) of FX3U-CAN, consult with your local Mitsubishi Electric representative.

Index (hex)	Sub-index (hex)	Object	Description / Set Range	Data Type	Initial Value	Read/Write	Stored to Flash ROM
1000	00	Device Type	Describes the device profile or the application profile • CANopen® 405 Mode: K405 • CANopen® 417 Mode: K417 Will be changed by setting BFM #21.	U32	K405	R	-
1001	00	Error Register	→ Refer to Subsection 5.6.2	U8	H0	R	-
1002	00	Reserved	-	-	-	-	-
1003	00	Pre-defined error field	→ Refer to Subsection 5.6.3	U8	H0	R/W	-
	01 to 0F			U32	H0	R	-
1004	00	Reserved	-	-	-	-	-
1005	00	COB-ID of SYNC message	→ Refer to Subsection 5.6.7	U32	H80	R/W	✓
1006	00	Communication Cycle Period	→ Refer to Subsection 5.6.7	U32	H0	R/W	✓
1007	00	Reserved	-	-	-	-	-
1008	00	Device Name	8 Byte ASCII String	Visible String	FX3U-CAN	R	-
1009	00	Hardware Version	4 Byte ASCII String	Visible String	X.XX	R	-

1	Introduction
2	Specifications
3	Installation
4	Wiring
5	Introduction of Functions
6	Allocation of Buffer Memories
7	Interface and Device Profile (405 mode)
8	Lift Application Profile (417 Mode)
9	CAN Layer 2 Mode
10	Command Interface

Index (hex)	Sub-index (hex)	Object	Description / Set Range	Data Type	Initial Value	Read/Write	Stored to Flash ROM	
100A	00	Software Version	4 Byte ASCII String	Visible String	X.XX	R	-	
100B	00	Reserved	-	-	-	-	-	
100C	00	Guard time ^{*1}	→ Refer to Subsection 5.6.8	U16	H0	R/W	✓	
100D	00	Life time factor ^{*1}	→ Refer to Subsection 5.6.8	U8	H0	R/W	✓	
100E to 100F	00	Reserved	-	-	-	-	-	
1010	00	Store parameters	Highest sub-index	U8	H01	R	-	
	01		Save all parameters → Refer to Subsection 5.6.11	U32	H1	R/W	-	
1011	00	Restore default parameters	Highest sub-index	U8	H01	R	-	
	01		Restore all parameters → Refer to Subsection 5.6.12	U32	H1	R/W	-	
1012	00	COB-ID Time	→ Refer to Subsection 5.6.10	U32	H8000 0100	R/W	✓	
1013	00	Reserved	-	-	-	-	-	
1014	00	COB-ID EMCY	→ Refer to Subsection 5.6.13	U32	H80 + Node-Id	R	-	
1015	00	Inhibit Time EMCY	→ Refer to Subsection 5.6.13	U16	H0	R/W	✓	
1016	00	Consumer heartbeat time	Highest sub-index	U8	H7F	R	-	
	01 to 7F		→ Refer to Subsection 5.6.9	U32	H0	R/W	✓	
1017	00	Producer heartbeat time	→ Refer to Subsection 5.6.9	U16	• CANopen® 405 Mode: K0 • CANopen® 417 Mode: K1000	R/W	✓	
1018	00	Identity Object	Highest sub-index	U8	H03	R	-	
	01		Vendor-ID	U32	H71	R	-	
	02		Product Code	U32	K7170	R	-	
	03		Revision Number	U32	HXXXX XXXX	R	-	
1019 to 101F	00	Reserved	-	-	-	-		
1020	00	Verify Configuration ^{*1}	Highest sub-index	U8	H02	R	-	
	01		→ Refer to Subsection 5.8.13	U32	H0	R/W	✓	
	02			U32	H0	R/W	✓	
1021 to 1027	00	Reserved	-	-	-	-		
1028	00	Emergency consumer object	Highest sub-index	U8	H7F	R	-	
	01 to 7F		→ Refer to Subsection 5.6.13	U32	H80 + Node-Id	R/W	✓	
1029	00	Error behaviour	Highest sub-index	U8	H01	R	-	
	01		→ Refer to Section 5.7	U8	H0	R/W	✓	
102A	00	NMT inhibit time ^{*1}	→ Refer to Subsection 5.8.7	U16	H0	R	✓	
102B to 13FF	00	Reserved	-	-	-	-	-	
1400 to 15F1	00	RPDO communication parameter	Highest sub-index	U8	→ Refer to Table 5.1 → Refer to Table 5.5		-	
	01		→ Refer to Subsection 5.6.5	COB-ID			U32	✓
	02			Transmission type			U8	✓
	03			Inhibit time			U16	✓
	04			Compatibility entry			U8	-
	05			Event-timer			U16	✓
15F2 to 15FF	00	Reserved		-	-	-	-	-

*1. Applicable for FX3U-CAN firmware Ver. 1.10 or later.

1	Introduction
2	Specifications
3	Installation
4	Wiring
5	Introduction of Functions
6	Allocation of Buffer Memories
7	Interface and Device Profile (405 mode)
8	Lift Application Profile (417 Mode)
9	CAN Layer 2 Mode
10	Command Interface

Index (hex)	Sub-index (hex)	Object	Description / Set Range	Data Type	Initial Value	Read/Write	Stored to Flash ROM
1600 to 17F1	00	RPDO mapping parameter	→ Refer to Subsection 5.6.5	Number of valid object entries	U8	→ Refer to Table 5.2 → Refer to Table 5.6 → Refer to Table 5.7	✓
	01			1 st Mapped object	U32		✓
	02			2 nd Mapped object	U32		✓
	03			3 rd Mapped object	U32		✓
	04			4 th Mapped object	U32		✓
	05			5 th Mapped object	U32		✓
	06			6 th Mapped object	U32		✓
	07			7 th Mapped object	U32		✓
	08			8 th Mapped object	U32		✓
17F2 to 17FF	00	Reserved	-	-	-	-	-
1800 to 1978	00	TPDO communication parameter	→ Refer to Subsection 5.6.5	Highest sub-index	U8	→ Refer to Table 5.3 → Refer to Table 5.8	-
	01			COB-ID	U32		✓
	02			Transmission type	U8		✓
	03			Inhibit time	U16		✓
	04			Compatibility entry	U8		-
	05			Event-timer	U16		✓
1979 to 19FF	00	Reserved	-	-	-	-	-
1A00 to 1B78	00	TPDO mapping parameter	→ Refer to Subsection 5.6.5	Number of valid object entries	U8	→ Refer to Table 5.4 → Refer to Table 5.9 → Refer to Table 5.10	✓
	01			1 st Mapped object	U32		✓
	02			2 nd Mapped object	U32		✓
	03			3 rd Mapped object	U32		✓
	04			4 th Mapped object	U32		✓
	05			5 th Mapped object	U32		✓
	06			6 th Mapped object	U32		✓
	07			7 th Mapped object	U32		✓
	08			8 th Mapped object	U32		✓
1B79 to 1F21	00	Reserved	-	-	-	-	-
1F22	00	Concise DCF	Highest sub-index	U8	H7F	R	-
	01 to 7F		→ Refer to Subsection 5.8.13 Node-ID value	DOMAIN	-	R/W	✓
1F23 to 1F24	00	Reserved	-	-	-	-	-
1F25	00	Configuration request	Highest sub-index	U8	H80	R	-
	01 to 7F		→ Refer to Subsection 5.8.13 Node-ID value	U32	H0	W	-
	80		ALL nodes				
1F26	00	Expected configuration date	Highest sub-index	U8	H7F	R	-
	01 to 7F		→ Refer to Subsection 5.8.13 Node-ID value	U32	H0	R/W	✓
1F27	00	Expected configuration time	Highest sub-index	U8	H7F	R	-
	01 to 7F		→ Refer to Subsection 5.8.13 Node-ID value	U32	H0	R/W	✓
1F28 to 1F7F	00	Reserved	-	-	-	-	-
1F80	00	NMT startup	→ Refer to Subsection 5.8.5	U32	H0	R/W	✓
1F81	00	NMT slave assignment	Highest sub-index	U8	H7F	R	-
	01 to 7F		→ Refer to Subsection 5.8.7 Node-ID value	U32	H0	R/W	✓

Index (hex)	Sub-index (hex)	Object	Description / Set Range	Data Type	Initial Value	Read/Write	Stored to Flash ROM	
1F82	00	Request NMT	Highest sub-index	U8	H80	R	-	
	01 to 7F		→ Refer to Subsection 5.8.9	Node-ID	U8	H0	R/W	-
	80		All nodes		-	W	-	
1F83	00	Request node guarding	Highest sub-index	U8	H80	R	-	
	01 to 7F		→ Refer to Subsection 5.8.10	Node-ID value	U8	H0	R/W	-
	80		All nodes			W	-	
1F84	00	Device type	Highest sub-index	U8	H7F	R	-	
	01 to 7F		→ Refer to Subsection 5.8.4		U32	H0	R/W	✓
1F85	00	Vendor identification	Highest sub-index	U8	H7F	R	-	
	01 to 7F		→ Refer to Subsection 5.8.4		U32	H0	R/W	✓
1F86	00	Product code	Highest sub-index	U8	H7F	R	-	
	01 to 7F		→ Refer to Subsection 5.8.4		U32	H0	R/W	✓
1F87	00	Revision number	Highest sub-index	U8	H7F	R	-	
	01 to 7F		→ Refer to Subsection 5.8.4		U32	H0	R/W	✓
1F88	00	Serial number	Highest sub-index	U8	H7F	R	-	
	01 to 7F		→ Refer to Subsection 5.8.4		U32	H0	R/W	✓
1F89	00	Boot time	→ Refer to Subsection 5.8.7	U32	H0	R/W	✓	
1F8A to 1F8F	00	Reserved	-	-	-	-	-	
1F90	00	NMT flying master timing parameters	Highest sub-index	U8	H06	R	-	
	01		→ Refer to Subsection 5.8.11	NMT master timeout	U16	K100	R/W	✓
	02		NMT master negotiation time delay	U16	K500	R/W	✓	
	03		NMT master priority	U16	K1	R/W	✓	
	04		Priority time slot	U16	K1500	R/W	✓	
	05		CANopen [®] device time slot	U16	K10	R/W	✓	
	06		Multiple NMT master detect cycle time	U16	K4000 + K10 * Node-ID	R/W	✓	
1F91 to 1FFF	00	Reserved	-	-	-	-	-	

Table 5.1: Mode 405 RPDO communication Parameter

R: Read access, W: Write access, Reserved: Not existing Index or Sub-index

Index (hex)	Default value of Sub-Index (hex)					
	H00 R	H01 RW	H02 RW	H03 RW	H04 -	H05 RW
1400	5	200 + Node-Id	FE	0	Reserved	0
1401	5	300 + Node-Id	FE	0	Reserved	0
1402	5	400 + Node-Id	FE	0	Reserved	0
1403	5	500 + Node-Id	FE	0	Reserved	0
1404 to 144F	5	80000000	FE	0	Reserved	0
1450 to 15F1	Reserved					

Table 5.2: Mode 405 RPDO mapping Parameter

R: Read access, W: Write access, Reserved: Not existing Index or Sub-index

Index (hex)	Default value of Sub-Index (hex)								
	H00 RW	H01 RW	H02 RW	H03 RW	H04 RW	H05 RW	H06 RW	H07 RW	H08 RW
1600	4	A5800110	A5800210	A5800310	A5800410	0	0	0	0
1601	4	A5800510	A5800610	A5800710	A5800810	0	0	0	0
1602	4	A5800910	A5800A10	A5800B10	A5800C10	0	0	0	0
1603	4	A5800D10	A5800E10	A5800F10	A5801010	0	0	0	0
1604	4	A5801110	A5801210	A5801310	A5801410	0	0	0	0
1605	4	A5801510	A5801610	A5801710	A5801810	0	0	0	0
1606	4	A5801910	A5801A10	A5801B10	A5801C10	0	0	0	0
1607	4	A5801D10	A5801E10	A5801F10	A5802010	0	0	0	0
1608	4	A5802110	A5802210	A5802310	A5802410	0	0	0	0
1609	4	A5802510	A5802610	A5802710	A5802810	0	0	0	0
160A	4	A5802910	A5802A10	A5802B10	A5802C10	0	0	0	0
160B	4	A5802D10	A5802E10	A5802F10	A5803010	0	0	0	0
160C	4	A5803110	A5803210	A5803310	A5803410	0	0	0	0
160D	4	A5803510	A5803610	A5803710	A5803810	0	0	0	0
160E	4	A5803910	A5803A10	A5803B10	A5803C10	0	0	0	0
160F	4	A5803D10	A5803E10	A5803F10	A5804010	0	0	0	0
1610	4	A5804110	A5804210	A5804310	A5804410	0	0	0	0
1611	4	A5804510	A5804610	A5804710	A5804810	0	0	0	0
1612	4	A5804910	A5804A10	A5804B10	A5804C10	0	0	0	0
1613	4	A5804D10	A5804E10	A5804F10	A5805010	0	0	0	0
1614	4	A5805110	A5805210	A5805310	A5805410	0	0	0	0
1615	4	A5805510	A5805610	A5805710	A5805810	0	0	0	0
1616	4	A5805910	A5805A10	A5805B10	A5805C10	0	0	0	0
1617	4	A5805D10	A5805E10	A5805F10	A5806010	0	0	0	0
1618	4	A5806110	A5806210	A5806310	A5806410	0	0	0	0
1619	4	A5806510	A5806610	A5806710	A5806810	0	0	0	0
161A	4	A5806910	A5806A10	A5806B10	A5806C10	0	0	0	0
161B	4	A5806D10	A5806E10	A5806F10	A5807010	0	0	0	0
161C	4	A5807110	A5807210	A5807310	A5807410	0	0	0	0
161D	4	A5807510	A5807610	A5807710	A5807810	0	0	0	0
161E	4	A5810110	A5810210	A5810310	A5810410	0	0	0	0
161F	4	A5810510	A5810610	A5810710	A5810810	0	0	0	0
1620	4	A5810910	A5810A10	A5810B10	A5810C10	0	0	0	0
1621	4	A5810D10	A5810E10	A5810F10	A5811010	0	0	0	0
1622	4	A5811110	A5811210	A5811310	A5811410	0	0	0	0
1623	4	A5811510	A5811610	A5811710	A5811810	0	0	0	0
1624	4	A5811910	A5811A10	A5811B10	A5811C10	0	0	0	0
1625	4	A5811D10	A5811E10	A5811F10	A5812010	0	0	0	0

- 1 Introduction
- 2 Specifications
- 3 Installation
- 4 Wiring
- 5 Introduction of Functions
- 6 Allocation of Buffer Memories
- 7 Interface and Device Profile (405 mode)
- 8 Lift Application Profile (417 Mode)
- 9 CAN Layer 2 Mode
- 10 Command Interface

Index (hex)	Default value of Sub-Index (hex)								
	H00 RW	H01 RW	H02 RW	H03 RW	H04 RW	H05 RW	H06 RW	H07 RW	H08 RW
1626	4	A5812110	A5812210	A5812310	A5812410	0	0	0	0
1627	4	A5812510	A5812610	A5812710	A5812810	0	0	0	0
1628	4	A5812910	A5812A10	A5812B10	A5812C10	0	0	0	0
1629	4	A5812D10	A5812E10	A5812F10	A5813010	0	0	0	0
162A	4	A5813110	A5813210	A5813310	A5813410	0	0	0	0
162B	4	A5813510	A5813610	A5813710	A5813810	0	0	0	0
162C	4	A5813910	A5813A10	A5813B10	A5813C10	0	0	0	0
162D	4	A5813D10	A5813E10	A5813F10	A5814010	0	0	0	0
162E	4	A5814110	A5814210	A5814310	A5814410	0	0	0	0
162F	4	A5814510	A5814610	A5814710	A5814810	0	0	0	0
1630	4	A5814910	A5814A10	A5814B10	A5814C10	0	0	0	0
1631	4	A5814D10	A5814E10	A5814F10	A5815010	0	0	0	0
1632	4	A5815110	A5815210	A5815310	A5815410	0	0	0	0
1633	4	A5815510	A5815610	A5815710	A5815810	0	0	0	0
1634	4	A5815910	A5815A10	A5815B10	A5815C10	0	0	0	0
1635	4	A5815D10	A5815E10	A5815F10	A5816010	0	0	0	0
1636	4	A5816110	A5816210	A5816310	A5816410	0	0	0	0
1637	4	A5816510	A5816610	A5816710	A5816810	0	0	0	0
1638	4	A5816910	A5816A10	A5816B10	A5816C10	0	0	0	0
1639	4	A5816D10	A5816E10	A5816F10	A5817010	0	0	0	0
163A	4	A5817110	A5817210	A5817310	A5817410	0	0	0	0
163B	4	A5817510	A5817610	A5817710	A5817810	0	0	0	0
163C	4	A5820110	A5820210	A5820310	A5820410	0	0	0	0
163D	4	A5820510	A5820610	A5820710	A5820810	0	0	0	0
163E	4	A5820910	A5820A10	A5820B10	A5820C10	0	0	0	0
163F	4	A5820D10	A5820E10	A5820F10	A5821010	0	0	0	0
1640	4	A5821110	A5821210	A5821310	A5821410	0	0	0	0
1641	4	A5821510	A5821610	A5821710	A5821810	0	0	0	0
1642	4	A5821910	A5821A10	A5821B10	A5821C10	0	0	0	0
1643	4	A5821D10	A5821E10	A5821F10	A5822010	0	0	0	0
1644	4	A5822110	A5822210	A5822310	A5822410	0	0	0	0
1645	4	A5822510	A5822610	A5822710	A5822810	0	0	0	0
1646	4	A5822910	A5822A10	A5822B10	A5822C10	0	0	0	0
1647	4	A5822D10	A5822E10	A5822F10	A5823010	0	0	0	0
1648	4	A5823110	A5823210	A5823310	A5823410	0	0	0	0
1649	4	A5823510	A5823610	A5823710	A5823810	0	0	0	0
164A	4	A5823910	A5823A10	A5823B10	A5823C10	0	0	0	0
164B	4	A5823D10	A5823E10	A5823F10	A5824010	0	0	0	0
164C	4	A5824110	A5824210	A5824310	A5824410	0	0	0	0
164D	4	A5824510	A5824610	A5824710	A5824810	0	0	0	0
164E	4	A5824910	A5824A10	A5824B10	A5824C10	0	0	0	0
164F	4	A5824D10	A5824E10	A5824F10	A5825010	0	0	0	0
1650 to 17F1	Reserved								

Table 5.3: Mode 405 TPDO communication Parameter

R: Read access, W: Write access, Reserved: Not existing Index or Sub-index

Index (hex)	Default value of Sub-Index (hex)					
	H00 R	H01 RW	H02 RW	H03 RW	H04 -	H05 RW
1800	5	4000 0180 + Node-Id	FE	0	Reserved	0
1801	5	4000 0280 + Node-Id	FE	0	Reserved	0
1802	5	4000 0380 + Node-Id	FE	0	Reserved	0
1803	5	4000 0480 + Node-Id	FE	0	Reserved	0
1804 to 184F	5	C0000000	FE	0	Reserved	0
1850 to 1978	Reserved					

Table 5.4: Mode 405 TPDO mapping Parameter

R: Read access, W: Write access, Reserved: Not existing Index or Sub-index

Index (hex)	Default value of Sub-Index (hex)								
	H00 RW	H01 RW	H02 RW	H03 RW	H04 RW	H05 RW	H06 RW	H07 RW	H08 RW
1A00	4	A1000110	A1000210	A1000310	A1000410	0	0	0	0
1A01	4	A1000510	A1000610	A1000710	A1000810	0	0	0	0
1A02	4	A1000910	A1000A10	A1000B10	A1000C10	0	0	0	0
1A03	4	A1000D10	A1000E10	A1000F10	A1001010	0	0	0	0
1A04	4	A1001110	A1001210	A1001310	A1001410	0	0	0	0
1A05	4	A1001510	A1001610	A1001710	A1001810	0	0	0	0
1A06	4	A1001910	A1001A10	A1001B10	A1001C10	0	0	0	0
1A07	4	A1001D10	A1001E10	A1001F10	A1002010	0	0	0	0
1A08	4	A1002110	A1002210	A1002310	A1002410	0	0	0	0
1A09	4	A1002510	A1002610	A1002710	A1002810	0	0	0	0
1A0A	4	A1002910	A1002A10	A1002B10	A1002C10	0	0	0	0
1A0B	4	A1002D10	A1002E10	A1002F10	A1003010	0	0	0	0
1A0C	4	A1003110	A1003210	A1003310	A1003410	0	0	0	0
1A0D	4	A1003510	A1003610	A1003710	A1003810	0	0	0	0
1A0E	4	A1003910	A1003A10	A1003B10	A1003C10	0	0	0	0
1A0F	4	A1003D10	A1003E10	A1003F10	A1004010	0	0	0	0
1A10	4	A1004110	A1004210	A1004310	A1004410	0	0	0	0
1A11	4	A1004510	A1004610	A1004710	A1004810	0	0	0	0
1A12	4	A1004910	A1004A10	A1004B10	A1004C10	0	0	0	0
1A13	4	A1004D10	A1004E10	A1004F10	A1005010	0	0	0	0
1A14	4	A1005110	A1005210	A1005310	A1005410	0	0	0	0
1A15	4	A1005510	A1005610	A1005710	A1005810	0	0	0	0
1A16	4	A1005910	A1005A10	A1005B10	A1005C10	0	0	0	0
1A17	4	A1005D10	A1005E10	A1005F10	A1006010	0	0	0	0
1A18	4	A1006110	A1006210	A1006310	A1006410	0	0	0	0
1A19	4	A1006510	A1006610	A1006710	A1006810	0	0	0	0
1A1A	4	A1006910	A1006A10	A1006B10	A1006C10	0	0	0	0
1A1B	4	A1006D10	A1006E10	A1006F10	A1007010	0	0	0	0
1A1C	4	A1007110	A1007210	A1007310	A1007410	0	0	0	0
1A1D	4	A1007510	A1007610	A1007710	A1007810	0	0	0	0
1A1E	4	A1010110	A1010210	A1010310	A1010410	0	0	0	0
1A1F	4	A1010510	A1010610	A1010710	A1010810	0	0	0	0
1A20	4	A1010910	A1010A10	A1010B10	A1010C10	0	0	0	0
1A21	4	A1010D10	A1010E10	A1010F10	A1011010	0	0	0	0
1A22	4	A1011110	A1011210	A1011310	A1011410	0	0	0	0
1A23	4	A1011510	A1011610	A1011710	A1011810	0	0	0	0
1A24	4	A1011910	A1011A10	A1011B10	A1011C10	0	0	0	0
1A25	4	A1011D10	A1011E10	A1011F10	A1012010	0	0	0	0

1	Introduction
2	Specifications
3	Installation
4	Wiring
5	Introduction of Functions
6	Allocation of Buffer Memories
7	Interface and Device Profile (405 mode)
8	Lift Application Profile (417 Mode)
9	CAN Layer 2 Mode
10	Command Interface

Index (hex)	Default value of Sub-Index (hex)								
	H00 RW	H01 RW	H02 RW	H03 RW	H04 RW	H05 RW	H06 RW	H07 RW	H08 RW
1A26	4	A1012110	A1012210	A1012310	A1012410	0	0	0	0
1A27	4	A1012510	A1012610	A1012710	A1012810	0	0	0	0
1A28	4	A1012910	A1012A10	A1012B10	A1012C10	0	0	0	0
1A29	4	A1012D10	A1012E10	A1012F10	A1013010	0	0	0	0
1A2A	4	A1013110	A1013210	A1013310	A1013410	0	0	0	0
1A2B	4	A1013510	A1013610	A1013710	A1013810	0	0	0	0
1A2C	4	A1013910	A1013A10	A1013B10	A1013C10	0	0	0	0
1A2D	4	A1013D10	A1013E10	A1013F10	A1014010	0	0	0	0
1A2E	4	A1014110	A1014210	A1014310	A1014410	0	0	0	0
1A2F	4	A1014510	A1014610	A1014710	A1014810	0	0	0	0
1A30	4	A1014910	A1014A10	A1014B10	A1014C10	0	0	0	0
1A31	4	A1014D10	A1014E10	A1014F10	A1015010	0	0	0	0
1A32	4	A1015110	A1015210	A1015310	A1015410	0	0	0	0
1A33	4	A1015510	A1015610	A1015710	A1015810	0	0	0	0
1A34	4	A1015910	A1015A10	A1015B10	A1015C10	0	0	0	0
1A35	4	A1015D10	A1015E10	A1015F10	A1016010	0	0	0	0
1A36	4	A1016110	A1016210	A1016310	A1016410	0	0	0	0
1A37	4	A1016510	A1016610	A1016710	A1016810	0	0	0	0
1A38	4	A1016910	A1016A10	A1016B10	A1016C10	0	0	0	0
1A39	4	A1016D10	A1016E10	A1016F10	A1017010	0	0	0	0
1A3A	4	A1017110	A1017210	A1017310	A1017410	0	0	0	0
1A3B	4	A1017510	A1017610	A1017710	A1017810	0	0	0	0
1A3C	4	A1020110	A1020210	A1020310	A1020410	0	0	0	0
1A3D	4	A1020510	A1020610	A1020710	A1020810	0	0	0	0
1A3E	4	A1020910	A1020A10	A1020B10	A1020C10	0	0	0	0
1A3F	4	A1020D10	A1020E10	A1020F10	A1021010	0	0	0	0
1A40	4	A1021110	A1021210	A1021310	A1021410	0	0	0	0
1A41	4	A1021510	A1021610	A1021710	A1021810	0	0	0	0
1A42	4	A1021910	A1021A10	A1021B10	A1021C10	0	0	0	0
1A43	4	A1021D10	A1021E10	A1021F10	A1022010	0	0	0	0
1A44	4	A1022110	A1022210	A1022310	A1022410	0	0	0	0
1A45	4	A1022510	A1022610	A1022710	A1022810	0	0	0	0
1A46	4	A1022910	A1022A10	A1022B10	A1022C10	0	0	0	0
1A47	4	A1022D10	A1022E10	A1022F10	A1023010	0	0	0	0
1A48	4	A1023110	A1023210	A1023310	A1023410	0	0	0	0
1A49	4	A1023510	A1023610	A1023710	A1023810	0	0	0	0
1A4A	4	A1023910	A1023A10	A1023B10	A1023C10	0	0	0	0
1A4B	4	A1023D10	A1023E10	A1023F10	A1024010	0	0	0	0
1A4C	4	A1024110	A1024210	A1024310	A1024410	0	0	0	0
1A4D	4	A1024510	A1024610	A1024710	A1024810	0	0	0	0
1A4E	4	A1024910	A1024A10	A1024B10	A1024C10	0	0	0	0
1A4F	4	A1024D10	A1024E10	A1024F10	A1025010	0	0	0	0
1A50 to 1B78	Reserved								

Table 5.5: Mode 417 RPDO communication Parameter

R: Read access, W: Write access, Reserved: Not existing Index or Sub-index

Index (hex)	Default value of Sub-Index (hex)					
	H00 R	H01 RW	H02 RW *1)/R	H03 RW	H04 -	H05 RW
1400	5	80000000	FF	0	Reserved	0
1401	2	501	FF *1)		Reserved	
1402	2	502	FF *1)		Reserved	
1403	2	503	FF *1)		Reserved	
1404	2	504	FF *1)		Reserved	
1405	2	505	FF *1)		Reserved	
1406	2	506	FF *1)		Reserved	
1407	2	507	FF *1)		Reserved	
1408	2	508	FF *1)		Reserved	
1409	2	509	FF *1)		Reserved	
140A	2	50A	FF *1)		Reserved	
140B	2	50B	FF *1)		Reserved	
140C	2	50C	FF *1)		Reserved	
140D	2	50D	FF *1)		Reserved	
140E	2	50E	FF *1)		Reserved	
140F	2	50F	FF *1)		Reserved	
1410	2	510	FF *1)		Reserved	
1411	2	511	FF *1)		Reserved	
1412	2	512	FF *1)		Reserved	
1413	2	513	FF *1)		Reserved	
1414	2	514	FF *1)		Reserved	
1415	2	515	FF *1)		Reserved	
1416	2	516	FF *1)		Reserved	
1417	2	517	FF *1)		Reserved	
1418	2	518	FF *1)		Reserved	
1419	2	519	FF *1)		Reserved	
141A	2	51A	FF *1)		Reserved	
141B	2	51B	FF *1)		Reserved	
141C	2	51C	FF *1)		Reserved	
141D	2	51D	FF *1)		Reserved	
141E	2	51E	FF *1)		Reserved	
141F	2	51F	FF *1)		Reserved	
1420	2	520	FF *1)		Reserved	
1421	2	521	FF *1)		Reserved	
1422	2	522	FF *1)		Reserved	
1423	2	523	FF *1)		Reserved	
1424	2	524	FF *1)		Reserved	
1425	2	525	FF *1)		Reserved	
1426	2	526	FF *1)		Reserved	
1427	2	527	FF *1)		Reserved	
1428	2	528	FF *1)		Reserved	
1429	2	529	FF *1)		Reserved	
142A	2	52A	FF *1)		Reserved	
142B	2	52B	FF *1)		Reserved	
142C	2	52C	FF *1)		Reserved	
142D	2	52D	FF *1)		Reserved	
142E	2	52E	FF *1)		Reserved	
142F	2	52F	FF *1)		Reserved	
1430	2	530	FF *1)		Reserved	
1431	2	531	FF *1)		Reserved	
1432	2	532	FF *1)		Reserved	

- 1 Introduction
- 2 Specifications
- 3 Installation
- 4 Wiring
- 5 Introduction of Functions
- 6 Allocation of Buffer Memories
- 7 Interface and Device Profile (405 mode)
- 8 Lift Application Profile (417 Mode)
- 9 CAN Layer 2 Mode
- 10 Command Interface

Index (hex)	Default value of Sub-Index (hex)					
	H00 R	H01 RW	H02 RW *1)/R	H03 RW	H04 -	H05 RW
1433	2	533	FF *1)		Reserved	
1434	2	534	FF *1)		Reserved	
1435	2	535	FF *1)		Reserved	
1436	2	536	FF *1)		Reserved	
1437	2	537	FF *1)		Reserved	
1438	2	538	FF *1)		Reserved	
1439	2	539	FF *1)		Reserved	
143A	2	53A	FF *1)		Reserved	
143B	2	53B	FF *1)		Reserved	
143C	2	53C	FF *1)		Reserved	
143D	2	53D	FF *1)		Reserved	
143E	2	53E	FF *1)		Reserved	
143F	2	53F	FF *1)		Reserved	
1440	2	540	FF *1)		Reserved	
1441	2	541	FF *1)		Reserved	
1442	2	542	FF *1)		Reserved	
1443	2	543	FF *1)		Reserved	
1444	2	544	FF *1)		Reserved	
1445	2	545	FF *1)		Reserved	
1446	2	546	FF *1)		Reserved	
1447	2	547	FF *1)		Reserved	
1448	2	548	FF *1)		Reserved	
1449	2	549	FF *1)		Reserved	
144A	2	54A	FF *1)		Reserved	
144B	2	54B	FF *1)		Reserved	
144C	2	54C	FF *1)		Reserved	
144D	2	54D	FF *1)		Reserved	
144E	2	54E	FF *1)		Reserved	
144F	2	54F	FF *1)		Reserved	
1450	2	550	FF *1)		Reserved	
1451	2	551	FF *1)		Reserved	
1452	2	552	FF *1)		Reserved	
1453	2	553	FF *1)		Reserved	
1454	2	554	FF *1)		Reserved	
1455	2	555	FF *1)		Reserved	
1456	2	556	FF *1)		Reserved	
1457	2	557	FF *1)		Reserved	
1458	2	558	FF *1)		Reserved	
1459	2	559	FF *1)		Reserved	
145A	2	55A	FF *1)		Reserved	
145B	2	55B	FF *1)		Reserved	
145C	2	55C	FF *1)		Reserved	
145D	2	55D	FF *1)		Reserved	
145E	2	55E	FF *1)		Reserved	
145F	2	55F	FF *1)		Reserved	
1460	2	560	FF *1)		Reserved	
1461	2	561	FF *1)		Reserved	
1462	2	562	FF *1)		Reserved	
1463	2	563	FF *1)		Reserved	
1464	2	564	FF *1)		Reserved	
1465	2	565	FF *1)		Reserved	
1466	2	566	FF *1)		Reserved	
1467	2	567	FF *1)		Reserved	

Index (hex)	Default value of Sub-Index (hex)					
	H00 R	H01 RW	H02 RW *1)/R	H03 RW	H04 -	H05 RW
1468	2	568	FF *1)		Reserved	
1469	2	569	FF *1)		Reserved	
146A	2	56A	FF *1)		Reserved	
146B	2	56B	FF *1)		Reserved	
146C	2	56C	FF *1)		Reserved	
146D	2	56D	FF *1)		Reserved	
146E	2	56E	FF *1)		Reserved	
146F	2	56F	FF *1)		Reserved	
1470	2	570	FF *1)		Reserved	
1471	2	571	FF *1)		Reserved	
1472	2	572	FF *1)		Reserved	
1473	2	573	FF *1)		Reserved	
1474	2	574	FF *1)		Reserved	
1475	2	575	FF *1)		Reserved	
1476	2	576	FF *1)		Reserved	
1477	2	577	FF *1)		Reserved	
1478	2	578	FF *1)		Reserved	
1479	2	579	FF *1)		Reserved	
147A	2	57A	FF *1)		Reserved	
147B	2	57B	FF *1)		Reserved	
147C	2	57C	FF *1)		Reserved	
147D	2	57D	FF *1)		Reserved	
147E	2	57E	FF *1)		Reserved	
147F	2	57F	FF *1)		Reserved	
1480					Reserved	
1481	5	481	FF	0	Reserved	0
1482	5	482	FF	0	Reserved	0
1483	5	483	FF	0	Reserved	0
1484	5	484	FF	0	Reserved	0
1485	5	485	FF	0	Reserved	0
1486	5	486	FF	0	Reserved	0
1487	5	487	FF	0	Reserved	0
1488	5	488	FF	0	Reserved	0
1489	5	489	FF	0	Reserved	0
148A	5	48A	FF	0	Reserved	0
148B	5	48B	FF	0	Reserved	0
148C	5	48C	FF	0	Reserved	0
148D	5	48D	FF	0	Reserved	0
148E	5	48E	FF	0	Reserved	0
148F	5	48F	FF	0	Reserved	0
1490	5	490	FF	0	Reserved	0
1491	5	491	FF	0	Reserved	0
1492	5	492	FF	0	Reserved	0
1493	5	493	FF	0	Reserved	0
1494	5	494	FF	0	Reserved	0
1495	5	495	FF	0	Reserved	0
1496	5	496	FF	0	Reserved	0
1497	5	497	FF	0	Reserved	0
1498	5	498	FF	0	Reserved	0
1499	5	499	FF	0	Reserved	0
149A	5	49A	FF	0	Reserved	0
149B	5	49B	FF	0	Reserved	0
149C	5	49C	FF	0	Reserved	0

- 1** Introduction
- 2** Specifications
- 3** Installation
- 4** Wiring
- 5** Introduction of Functions
- 6** Allocation of Buffer Memories
- 7** Interface and Device Profile (405 mode)
- 8** Lift Application Profile (417 Mode)
- 9** CAN Layer 2 Mode
- 10** Command Interface

Index (hex)	Default value of Sub-Index (hex)					
	H00 R	H01 RW	H02 RW *1)/R	H03 RW	H04 -	H05 RW
149D	5	49D	FF	0	Reserved	0
149E	5	49E	FF	0	Reserved	0
149F	5	49F	FF	0	Reserved	0
14A0	5	4A0	FF	0	Reserved	0
14A1	5	4A1	FF	0	Reserved	0
14A2	5	4A2	FF	0	Reserved	0
14A3	5	4A3	FF	0	Reserved	0
14A4	5	4A4	FF	0	Reserved	0
14A5	5	4A5	FF	0	Reserved	0
14A6	5	4A6	FF	0	Reserved	0
14A7	5	4A7	FF	0	Reserved	0
14A8	5	4A8	FF	0	Reserved	0
14A9	5	4A9	FF	0	Reserved	0
14AA	5	4AA	FF	0	Reserved	0
14AB	5	4AB	FF	0	Reserved	0
14AC	5	4AC	FF	0	Reserved	0
14AD	5	4AD	FF	0	Reserved	0
14AE	5	4AE	FF	0	Reserved	0
14AF	5	4AF	FF	0	Reserved	0
14B0	5	4B0	FF	0	Reserved	0
14B1	5	4B1	FF	0	Reserved	0
14B2	5	4B2	FF	0	Reserved	0
14B3	5	4B3	FF	0	Reserved	0
14B4	5	4B4	FF	0	Reserved	0
14B5	5	4B5	FF	0	Reserved	0
14B6	5	4B6	FF	0	Reserved	0
14B7	5	4B7	FF	0	Reserved	0
14B8	5	4B8	FF	0	Reserved	0
14B9	5	4B9	FF	0	Reserved	0
14BA	5	4BA	FF	0	Reserved	0
14BB	5	4BB	FF	0	Reserved	0
14BC	5	4BC	FF	0	Reserved	0
14BD	5	4BD	FF	0	Reserved	0
14BE	5	4BE	FF	0	Reserved	0
14BF	5	4BF	FF	0	Reserved	0
14C0	5	4C0	FF	0	Reserved	0
14C1 to 1500	Reserved					
1501	5	188	FF	0	Reserved	0
1502	Reserved					
1503	5	183	FF	0	Reserved	0
1504	Reserved					
1505	5	181	FF	0	Reserved	0
1506	5	18C	FF	0	Reserved	0
1507	5	18D	FF	0	Reserved	0
1508 to 1509	Reserved					
150A	5	201	FF	0	Reserved	0
150B	5	205	FF	0	Reserved	0
150C	5	202	FF	0	Reserved	0
150D	5	206	FF	0	Reserved	0
150E	5	203	FF	0	Reserved	0
150F	5	207	FF	0	Reserved	0
1510	Reserved					
1511	5	198	FF	0	Reserved	0

Index (hex)	Default value of Sub-Index (hex)					
	H00 R	H01 RW	H02 RW *1)/R	H03 RW	H04 -	H05 RW
1512	Reserved					
1513	5	193	FF	0	Reserved	0
1514	Reserved					
1515	5	191	FF	0	Reserved	0
1516	5	19C	FF	0	Reserved	0
1517	5	19D	FF	0	Reserved	0
1518 to 1519	Reserved					
151A	5	211	FF	0	Reserved	0
151B	5	215	FF	0	Reserved	0
151C	5	212	FF	0	Reserved	0
151D	5	216	FF	0	Reserved	0
151E	5	213	FF	0	Reserved	0
151F	5	217	FF	0	Reserved	0
1520	Reserved					
1521	5	1A8	FF	0	Reserved	0
1522	Reserved					
1523	5	1A3	FF	0	Reserved	0
1524	Reserved					
1525	5	1A1	FF	0	Reserved	0
1526	5	1AC	FF	0	Reserved	0
1527	5	1AD	FF	0	Reserved	0
1528 to 1529	Reserved					
152A	5	221	FF	0	Reserved	0
152B	5	225	FF	0	Reserved	0
152C	5	222	FF	0	Reserved	0
152D	5	226	FF	0	Reserved	0
152E	5	223	FF	0	Reserved	0
152F	5	227	FF	0	Reserved	0
1530	Reserved					
1531	5	1B8	FF	0	Reserved	0
1532	Reserved					
1533	5	1B3	FF	0	Reserved	0
1534	Reserved					
1535	5	1B1	FF	0	Reserved	0
1536	5	1BC	FF	0	Reserved	0
1537	5	1BD	FF	0	Reserved	0
1538 to 1539	Reserved					
153A	5	231	FF	0	Reserved	0
153B	5	235	FF	0	Reserved	0
153C	5	232	FF	0	Reserved	0
153D	5	236	FF	0	Reserved	0
153E	5	233	FF	0	Reserved	0
153F	5	237	FF	0	Reserved	0
1540	Reserved					
1541	5	1C8	FF	0	Reserved	0
1542	Reserved					
1543	5	1C3	FF	0	Reserved	0
1544	Reserved					
1545	5	1C1	FF	0	Reserved	0
1546	5	1CC	FF	0	Reserved	0
1547	5	1CD	FF	0	Reserved	0
1548 to 1549	Reserved					
154A	5	241	FF	0	Reserved	0

1	Introduction
2	Specifications
3	Installation
4	Wiring
5	Introduction of Functions
6	Allocation of Buffer Memories
7	Interface and Device Profile (405 mode)
8	Lift Application Profile (417 Mode)
9	CAN Layer 2 Mode
10	Command Interface

Index (hex)	Default value of Sub-Index (hex)					
	H00 R	H01 RW	H02 RW *1)/R	H03 RW	H04 -	H05 RW
154B	5	245	FF	0	Reserved	0
154C	5	242	FF	0	Reserved	0
154D	5	246	FF	0	Reserved	0
154E	5	243	FF	0	Reserved	0
154F	5	247	FF	0	Reserved	0
1550	Reserved					
1551	5	1D8	FF	0	Reserved	0
1552	Reserved					
1553	5	1D3	FF	0	Reserved	0
1554	Reserved					
1555	5	1D1	FF	0	Reserved	0
1556	5	1DC	FF	0	Reserved	0
1557	5	1DD	FF	0	Reserved	0
1558 to 1559	Reserved					
155A	5	251	FF	0	Reserved	0
155B	5	255	FF	0	Reserved	0
155C	5	252	FF	0	Reserved	0
155D	5	256	FF	0	Reserved	0
155E	5	253	FF	0	Reserved	0
155F	5	257	FF	0	Reserved	0
1560	Reserved					
1561	5	1E8	FF	0	Reserved	0
1562	Reserved					
1563	5	1E3	FF	0	Reserved	0
1564	Reserved					
1565	5	1E1	FF	0	Reserved	0
1566	5	1EC	FF	0	Reserved	0
1567	5	1ED	FF	0	Reserved	0
1568 to 1569	Reserved					
156A	5	261	FF	0	Reserved	0
156B	5	265	FF	0	Reserved	0
156C	5	262	FF	0	Reserved	0
156D	5	266	FF	0	Reserved	0
156E	5	263	FF	0	Reserved	0
156F	5	267	FF	0	Reserved	0
1570	Reserved					
1571	5	1F8	FF	0	Reserved	0
1572	Reserved					
1573	5	1F3	FF	0	Reserved	0
1574	Reserved					
1575	5	1F1	FF	0	Reserved	0
1576	5	1FC	FF	0	Reserved	0
1577	5	1FD	FF	0	Reserved	0
1578 to 1579	Reserved					
157A	5	271	FF	0	Reserved	0
157B	5	275	FF	0	Reserved	0
157C	5	272	FF	0	Reserved	0
157D	5	276	FF	0	Reserved	0
157E	5	273	FF	0	Reserved	0
157F	5	277	FF	0	Reserved	0
1580	5	18E	FF	0	Reserved	0
1581	5	18F	FF	0	Reserved	0
1582 to 158F	Reserved					

Index (hex)	Default value of Sub-Index (hex)					
	H00 R	H01 RW	H02 RW *1)/R	H03 RW	H04 -	H05 RW
1590	5	19E	FF	0	Reserved	0
1591	5	19F	FF	0	Reserved	0
1592 to 159F	Reserved					
15A0	5	1AE	FF	0	Reserved	0
15A1	5	1AF	FF	0	Reserved	0
15A2 to 15AF	Reserved					
15B0	5	1BE	FF	0	Reserved	0
15B1	5	1BF	FF	0	Reserved	0
15B2 to 15BF	Reserved					
15C0	5	1CE	FF	0	Reserved	0
15C1	5	1CF	FF	0	Reserved	0
15C2 to 15CF	Reserved					
15D0	5	1DE	FF	0	Reserved	0
15D1	5	1DF	FF	0	Reserved	0
15D2 to 15DF	Reserved					
15E0	5	1EE	FF	0	Reserved	0
15E1	5	1EF	FF	0	Reserved	0
15E2 to 15EF	Reserved					
15F0	5	1FE	FF	0	Reserved	0
15F1	5	1FF	FF	0	Reserved	0

Table 5.6: Mode 417 RPDO mapping Parameter part 1

R: Read access, W: Write access, Reserved: Not existing Index or Sub-index

Index (hex)	Default value of Sub-Index (hex)								
	H00 RW	H01 RW	H02 RW	H03 RW	H04 RW	H05 RW	H06 RW	H07 RW	H08 RW
1600	4	A5800110	A5800210	A5800310	A5800410	0	0	0	0

Table 5.7: Mode 417 RPDO mapping Parameter part 2

R: Read access, W: Write access, Reserved: Not existing Index or Sub-index

Index (hex)	Default value of Sub-Index (hex)					
	H00 R	H01 R	H02 R	H03 R	H04 R	H05 to H08 -
1601 to 167F	FF	Reserved				
1680	Reserved					
1681 to 16C0	01	60110030	Reserved			
16C1 to 1700	Reserved					
1701	02	64820108	64800110	Reserved		
1702	Reserved					
1703	04	64010010	64040008	00050008	64330020	Reserved
1704	Reserved					
1705	01	64060020	Reserved			
1706	01	63830120	Reserved			
1707	01	63830220	Reserved			
1708 to 1709	Reserved					
170A	02	63010110	63020110	Reserved		
170B	01	63100108	Reserved			
170C	02	63010210	63020210	Reserved		
170D	01	63100208	Reserved			
170E	02	63010310	63020310	Reserved		
170F	01	63100308	Reserved			
1710	Reserved					

- 1 Introduction
- 2 Specifications
- 3 Installation
- 4 Wiring
- 5 Introduction of Functions
- 6 Allocation of Buffer Memories
- 7 Interface and Device Profile (405 Mode)
- 8 Lift Application Profile (417 Mode)
- 9 CAN Layer 2 Mode
- 10 Command Interface

Index (hex)	Default value of Sub-Index (hex)					
	H00 R	H01 R	H02 R	H03 R	H04 R	H05 to H08 -
1711	02	6C820108	6C800110	Reserved		
1712	Reserved					
1713	04	6C010010	6C040008	00050008	6C330020	Reserved
1714	Reserved					
1715	01	6C060020	Reserved			
1716	01	6B830120	Reserved			
1717	01	6B830220	Reserved			
1718 to 1719	Reserved					
171A	02	6B010110	6B020110	Reserved		
171B	01	6B100108	Reserved			
171C	02	6B010210	6B020210	Reserved		
171D	01	6B100208	Reserved			
171E	02	6B010310	6B020310	Reserved		
171F	01	6B100308	Reserved			
1720	Reserved					
1721	02	74820108	74800110	Reserved		
1722	Reserved					
1723	04	74010010	74040008	00050008	74330020	Reserved
1724	Reserved					
1725	01	74060020	Reserved			
1726	01	73830120	Reserved			
1727	01	73830220	Reserved			
1728 to 1729	Reserved					
172A	02	73010110	73020110	Reserved		
172B	01	73100108	Reserved			
172C	02	73010210	73020210	Reserved		
172D	01	73100208	Reserved			
172E	02	73010310	73020310	Reserved		
172F	01	73100308	Reserved			
1730	Reserved					
1731	02	7C820108	7C800110	Reserved		
1732	Reserved					
1733	04	7C010010	7C040008	00050008	7C330020	Reserved
1734	Reserved					
1735	01	7C060020	Reserved			
1736	01	7B830120	Reserved			
1737	01	7B830220	Reserved			
1738 to 1739	Reserved					
173A	02	7B010110	7B020110	Reserved		
173B	01	7B100108	Reserved			
173C	02	7B010210	7B020210	Reserved		
173D	01	7B100208	Reserved			
173E	02	7B010310	7B020310	Reserved		
173F	01	7B100308	Reserved			
1740	Reserved					
1741	02	84820108	84800110	Reserved		
1742	Reserved					
1743	04	84010010	84040008	00050008	84330020	Reserved
1744	Reserved					
1745	01	84060020	Reserved			
1746	01	83830120	Reserved			
1747	01	83830220	Reserved			
1748 to 1749	Reserved					

Index (hex)	Default value of Sub-Index (hex)					
	H00 R	H01 R	H02 R	H03 R	H04 R	H05 to H08 -
174A	02	83010110	83020110	Reserved		
174B	01	83100108	Reserved			
174C	02	83010210	83020210	Reserved		
174D	01	83100208	Reserved			
174E	02	83010310	83020310	Reserved		
174F	01	83100308	Reserved			
1750	Reserved					
1751	02	8C820108	8C800110	Reserved		
1752	Reserved					
1753	04	8C010010	8C040008	00050008	8C330020	Reserved
1754	Reserved					
1755	01	8C060020	Reserved			
1756	01	8B830120	Reserved			
1757	01	8B830220	Reserved			
1758 to 1759	Reserved					
175A	02	8B010110	8B020110	Reserved		
175B	01	8B100108	Reserved			
175C	02	8B010210	8B020210	Reserved		
175D	01	8B100208	Reserved			
175E	02	8B010310	8B020310	Reserved		
175F	01	8B100308	Reserved			
1760	Reserved					
1761	02	94820108	94800110	Reserved		
1762	Reserved					
1763	04	94010010	94040008	00050008	94330020	Reserved
1764	Reserved					
1765	01	94060020	Reserved			
1766	01	93830120	Reserved			
1767	01	93830220	Reserved			
1768 to 1769	Reserved					
176A	02	93010110	93020110	Reserved		
176B	01	93100108	Reserved			
176C	02	93010210	93020210	Reserved		
176D	01	93100208	Reserved			
176E	02	93010310	93020310	Reserved		
176F	01	93100308	Reserved			
1770	Reserved					
1771	02	9C820108	9C800110	Reserved		
1772	Reserved					
1773	04	9C010010	9C040008	00050008	9C330020	Reserved
1774	Reserved					
1775	01	9C060020	Reserved			
1776	01	9B830120	Reserved			
1777	01	9B830220	Reserved			
1778 to 1779	Reserved					
177A	02	9B010110	9B020110	Reserved		
177B	01	9B100108	Reserved			
177C	02	9B010210	9B020210	Reserved		
177D	01	9B100208	Reserved			
177E	02	9B010310	9B020310	Reserved		
177F	01	9B100308	Reserved			
1780	01	63830320	Reserved			
1781	01	63830420	Reserved			

1	Introduction
2	Specifications
3	Installation
4	Wiring
5	Introduction of Functions
6	Allocation of Buffer Memories
7	Interface and Device Profile (405 mode)
8	Lift Application Profile (417 Mode)
9	CAN Layer 2 Mode
10	Command Interface

Index (hex)	Default value of Sub-Index (hex)					
	H00 R	H01 R	H02 R	H03 R	H04 R	H05 to H08 -
1782 to 178F	Reserved					
1790	01	6B830320	Reserved		Reserved	
1791	01	6B830420	Reserved		Reserved	
1792 to 179F	Reserved					
17A0	01	73830320	Reserved		Reserved	
17A1	01	73830420	Reserved		Reserved	
17A2 to 17AF	Reserved					
17B0	01	7B830320	Reserved		Reserved	
17B1	01	7B830420	Reserved		Reserved	
17B2 to 17BF	Reserved					
17C0	01	83830320	Reserved		Reserved	
17C1	01	83830420	Reserved		Reserved	
17C2 to 17CF	Reserved					
17D0	01	8B830320	Reserved		Reserved	
17D1	01	8B830420	Reserved		Reserved	
17D2 to 17DF	Reserved					
17E0	01	93830320	Reserved		Reserved	
17E1	01	93830420	Reserved		Reserved	
17E2 to 17EF	Reserved					
17F0	01	9B830320	Reserved		Reserved	
17F1	01	9B830420	Reserved		Reserved	

Table 5.8: Mode 417 TPDO communication Parameter

R: Read access, W: Write access, Reserved: Not existing Index or Sub-index

Index (hex)	Default value of Sub-Index (hex)					
	H00 R	H01 RW	H02 RW *1)/R	H03 RW	H04 -	H05 RW
1800	5	80000000	FF	0	Reserved	0
1801	2	500 + Node Id	FF *1)	Reserved		
1802 to 18FF	Reserved					
1900	5	40000400	FF	0	Reserved	0
1901	Reserved					
1902	5	C0000182	FF	0	Reserved	0
1903	Reserved					
1904	5	C0000180	FF	0	Reserved	0
1905 to 1907	Reserved					
1908	5	C0000200	FF	0	Reserved	0
1909 to 1911	Reserved					
1912	5	C0000192	FF	0	Reserved	0
1913	Reserved					
1914	5	C0000190	FF	0	Reserved	0
1915 to 1917	Reserved					
1918	5	C0000210	FF	0	Reserved	0
1919 to 1921	Reserved					
1922	5	C00001A2	FF	0	Reserved	0
1923	Reserved					
1924	5	C00001A0	FF	0	Reserved	0
1925 to 1927	Reserved					
1928	5	C0000220	FF	0	Reserved	0
1929 to 1931	Reserved					
1932	5	C00001B2	FF	0	Reserved	0
1933	Reserved					

Index (hex)	Default value of Sub-Index (hex)					
	H00 R	H01 RW	H02 RW *1)/R	H03 RW	H04 -	H05 RW
1934	5	C00001B0	FF	0	Reserved	0
1935 to 1937	Reserved					
1938	5	C0000230	FF	0	Reserved	0
1939 to 1941	Reserved					
1942	5	C00001C2	FF	0	Reserved	0
1943	Reserved					
1944	5	C00001C0	FF	0	Reserved	0
1945 to 1947	Reserved					
1948	5	C0000240	FF	0	Reserved	0
1949 to 1951	Reserved					
1952	5	C00001D2	FF	0	Reserved	0
1953	Reserved					
1954	5	C00001D0	FF	0	Reserved	0
1955 to 1957	Reserved					
1958	5	C0000250	FF	0	Reserved	0
1959 to 1961	Reserved					
1962	5	C00001E2	FF	0	Reserved	0
1963	Reserved					
1964	5	C00001E0	FF	0	Reserved	0
1965 to 1967	Reserved					
1968	5	C0000260	FF	0	Reserved	0
1969 to 1971	Reserved					
1972	5	C00001F2	FF	0	Reserved	0
1973	Reserved					
1974	5	C00001F0	FF	0	Reserved	0
1975 to 1977	Reserved					
1978	5	C0000270	FF	0	Reserved	0

Table 5.9: Mode 417 TPDO mapping Parameter part 1

R: Read access, W: Write access, Reserved: Not existing Index or Sub-index

Index (hex)	Default value of Sub-Index (hex)								
	H00 RW	H01 RW	H02 RW	H03 RW	H04 RW	H05 RW	H06 RW	H07 RW	H08 RW
1A00	4	A1000110	A1000210	A1000310	A1000410	0	0	0	0

Table 5.10: Mode 417 TPDO mapping Parameter part 2

R: Read access, W: Write access, Reserved: Not existing Index or Sub-index

Index (hex)	Default value of Sub-Index (hex)								
	H00 R	H01 R	H02 R	H03 R	H04 R	H05 R	H06 R	H07 R	H08 R
1A01	FF	Reserved							
1A02 to 1AFF	Reserved								
1B00	01	60110030	Reserved						
1B01	Reserved								
1B02	04	64000010	64030008	67FE0008	64300020	Reserved			
1B03	Reserved								
1B04	02	64200020	64230020	Reserved					
1B05 to 1B07	Reserved								
1B08	04	63000110	63000210	63000310	63000410	Reserved			
1B09 to 1B11	Reserved								
1B12	04	6C000010	6C300008	67FE0008	6C000020	Reserved			
1B13	Reserved								

1	Introduction
2	Specifications
3	Installation
4	Wiring
5	Introduction of Functions
6	Allocation of Buffer Memories
7	Interface and Device Profile (405 Mode)
8	Lift Application Profile (417 Mode)
9	CAN Layer 2 Mode
10	Command Interface

Index (hex)	Default value of Sub-Index (hex)								
	H00 R	H01 R	H02 R	H03 R	H04 R	H05 R	H06 R	H07 R	H08 R
1B14	02	6C000020	6C300020	Reserved					
1B15 to 1B17	Reserved								
1B18	04	6B000110	6B000210	6C000310	6C000410	Reserved			
1B19 to 1B21	Reserved								
1B22	04	74000010	74030008	67FE0008	74300020	Reserved			
1B23	Reserved								
1B24	02	74200020	74230020	Reserved					
1B25 to 1B27	Reserved								
1B28	04	73000110	73000210	73000310	73000410	Reserved			
1B29 to 1B31	Reserved								
1B32	04	7C000010	7C300008	67FE0008	7C000020	Reserved			
1B33	Reserved								
1B34	02	7C000020	7C300020	Reserved					
1B35 to 1B37	Reserved								
1B38	04	7B000110	7B000210	7C000310	7C000410	Reserved			
1B39 to 1B41	Reserved								
1B42	04	84000010	84030008	67FE0008	84300020	Reserved			
1B43	Reserved								
1B44	02	84200020	84230020	Reserved					
1B45 to 1B47	Reserved								
1B48	04	83000110	83000210	83000310	83000410	Reserved			
1B49 to 1B51	Reserved								
1B52	04	8C000010	8C300008	87FE0008	8C000020	Reserved			
1B53	Reserved								
1B54	02	8C000020	8C300020	Reserved					
1B55 to 1B57	Reserved								
1B58	04	8B000110	8B000210	8C000310	8C000410	Reserved			
1B59 to 1B61	Reserved								
1B62	04	94000010	94030008	67FE0008	94300020	Reserved			
1B63	Reserved								
1B64	02	94200020	94230020	Reserved					
1B65 to 1B67	Reserved								
1B68	04	93000110	93000210	93000310	93000410	Reserved			
1B69 to 1B71	Reserved								
1B72	04	9C000010	9C300008	67FE0008	9C000020	Reserved			
1B73	Reserved								
1B74	02	9C000020	9C300020	Reserved					
1B75 to 1B77	Reserved								
1B78	04	9B000110	9B000210	9C000310	9C000410	Reserved			

5.6.1 CAN-ID / COB-ID

Each message type on each device has a unique 11-bit identifier for bus arbitration and identification on the CAN bus. The lowest CAN-ID wins the bus arbitration. CAN-IDs with lower priority (higher CAN-ID) will wait until the bus is free.

For easier configuration, one CAN-ID scheme exists for all CANopen® devices. By default four TPDO and four RPDO are reserved for every Node-ID. To use more PDO for one node, it is necessary to use CAN-IDs of other nodes.

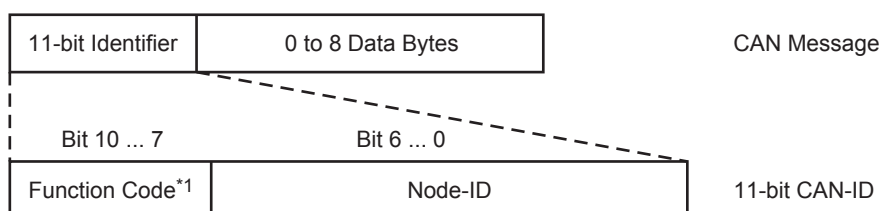

*1. Function code is shown below.

1. Broadcast objects (Node-ID = 0)

COB	Function Code (Binary)	Resulting CAN-ID
NMT	0000b	H0
SYNC	0001b	H80
TIME	0010b	H100

2. Peer-to-peer objects (Node-ID = 1 to 127)

COB	Function Code (Binary)	Resulting CAN-ID
EMCY	0001b	H81 to HFF
TPDO1	0011b	H181 to H1FF
RPDO1	0100b	H201 to H27F
TPDO2	0101b	H281 to H2FF
RPDO2	0110b	H301 to H37F
TPDO3	0111b	H381 to H3FF
RPDO3	1000b	H401 to H47F
TPDO4	1001b	H481 to H4FF
RPDO4	1010b	H501 to H57F
TSDO	1011b	H581 to H5FF
RSDO	1100b	H601 to H67F
NMT error control	1110b	H701 to H77F

3. Restricted CAN-IDs

In a self defined CAN-ID scheme, use of the following CAN-IDs are restricted and shall not be used as a CAN-ID by any configurable communication object.

CAN-ID (hex)	Used by COB
0	NMT
1 to 7F	Reserved
101 to 180	Reserved
581 to 5FF	Default TSDO
601 to 67F	Default RSDO
6E0 to 6FF	Reserved
701 to 77F	NMT Error Control
780 to 7FF	Reserved

1	Introduction
2	Specifications
3	Installation
4	Wiring
5	Introduction of Functions
6	Allocation of Buffer Memories
7	Interface and Device Profile (405 mode)
8	Lift Application Profile (417 Mode)
9	CAN Layer 2 Mode
10	Command Interface

5.6.2 Error Register

The object H1001 provides error information. The CANopen® device maps internal errors into this object. It is a part of the emergency object.

7	6	5	4	3	2	1	0
Manufacturer specific*1	H0	Device profile specific	Communication error (overrun, error state)*1	Temperature	Voltage	Current	Generic error*1

*1. Used by the FX3U-CAN Firmware.

The Generic error bit will always be set as long as the EMCY error code is bigger than H00FF.

The Error Register can be cleared by clearing the Pre-defined error field in object H1003.

All of these bits can be set by the Emergency message transmission command in the Command Interface.

→ For EMCY, refer to Subsection 5.6.13

→ For pre-defined error field, refer to Subsection 5.6.3

→ For emergency message transmission command, refer to Section 10.5

5.6.3 Pre-defined error field

This object H1003 provides the errors that occurred on the module and were signalled via the emergency object.

1) Sub-index H00: Number of errors

The Sub-index H00 displays the number of errors that are recorded. Writing H0 to this Sub-index deletes the entire history. Write values other than H0 are not allowed.

2) Sub-index H01 to H0F: Standard error fields

List of the last 15 EMCY Errors sent by FX3U-CAN. Sub-index H01 contains the newest Message and Sub-index H0F contains the oldest Message.

→ For Emergency error codes, refers to Section 6.23

5.6.4 SDO

An SDO provides direct access to object entries of a CANopen® device's object dictionary. These object entries may contain data of arbitrary size and data type. SDO is used to transfer multiple data sets from a client to a server and vice versa. The client controls which data set to transfer via a multiplexer (index and sub-index of the object dictionary). By using the CIF, it is possible to make an SDO access to other CANopen® devices or to the FX3U-CAN itself. In the Object Dictionary, no configuration needed.

→ For CIF, refer to Chapter 10

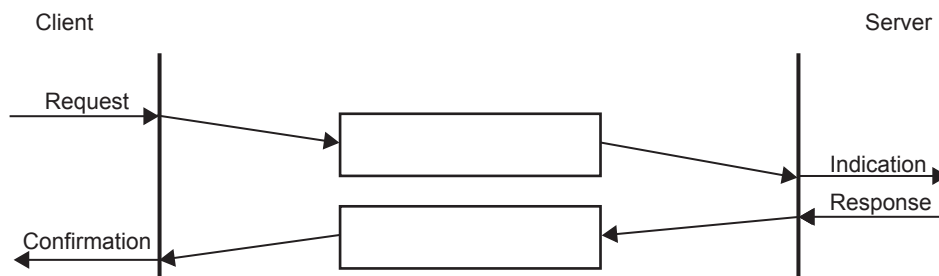

5.6.5 RPDO / TPDO

Real-time data transfer is performed by means of Process Data Objects (PDO). PDO transfer is performed with no protocol overhead.

PDOs correspond to objects in the object dictionary and provide the interface to the application objects. Data type and mapping of application objects into a PDO is determined by a corresponding default PDO mapping structure within the object dictionary. The variable mapping of PDO and the mapping of application objects into a PDO may be transmitted to a CANopen[®] device during the configuration process by applying the SDO services to the corresponding objects of the object dictionary.

The PDO communication parameter describes the communication capabilities of the PDO. The PDO mapping parameter contains information about the contents of the PDO.

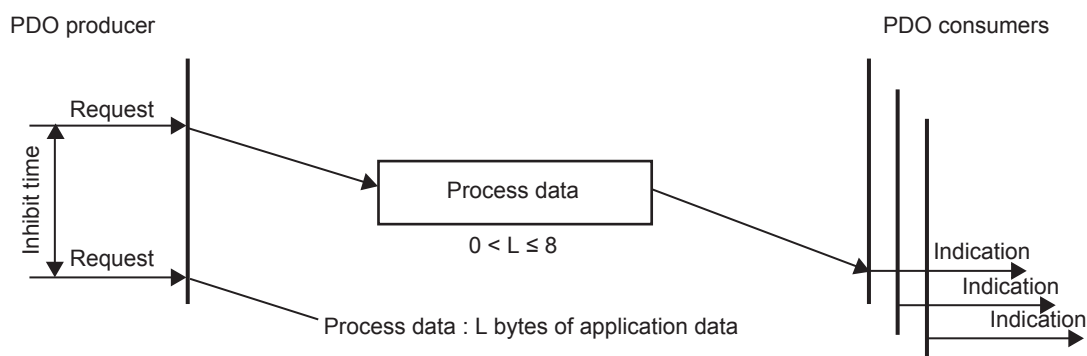

With the transmission type Parameter, two transmission modes are configurable:

- Synchronous transmission
- Event-driven transmission

Use the following procedure to change the PDO communication or mapping parameter:

- 1) The PDO must be set to invalid (Communication Parameter Sub-index H01 bit 31).
- 2) Set the communication Parameters
- 3) Set the mapping Parameters
 - Set Sub-Index H00 to the value H00.
 - Modify the mapping at Sub-Indexes H01 to H08.
 - Enable the mapping by setting the Sub-index H00 to the number of mapped objects.
- 4) Set the PDO to valid (Communication Parameter Sub-index H01 bit 31).

For unneeded data in an RPDO, a dummy mapping entry can be made to the data type definition Indexes to make the RPDO length fit the length of the TPDO accordingly.

→ For data type definitions indexes, refer to Section 5.5

1

Introduction

2

Specifications

3

Installation

4

Wiring

5

Introduction of Functions

6

Allocation of Buffer Memories

7

Interface and Device Profile (405 mode)

8

Lift Application Profile (417 Mode)

9

CAN Layer 2 Mode

10

Command Interface

1. Object H1400 to H144F

1) Sub-index H01: RPDO COB-ID

31	30	29	28 ... 11	10 ... 0
Valid	Reserved	H0	H0000	11-bit CAN-ID

Bit No.	Item	Description
Bit 0 to 10	11-bit CAN-ID	11-bit CAN-ID of the CAN base frame → For COB-ID, refer to Subsection 5.6.1
Bit 11 to 28	-	Bit 11 to 28 fixed to OFF (0).
Bit 29	-	Bit 29 fixed to OFF (0).
Bit 30	Reserved	This bit fixed to OFF (0).
Bit 31	Valid	OFF (0): Valid ON (1): Invalid

2) Sub-index H02: RPDO transmission type

Value (hex)	Description
00 to F0	Synchronous Received PDO data will be processed after the next SYNC message, independent of the transmission rate specified by the transmission type.
F1 to FD	Reserved
FE	Event-driven (Function Mode 405)
FF	Event-driven (Function Mode 417)

3) Sub-index H03: RPDO inhibit time

For RPDOs, the inhibit time has no function.

4) Sub-index H05: RPDO event-timer

The RPDO event timer is used for deadline monitoring.

When the time elapsed without receiving an event driven object (transmission type is set to HFE or HFF) an EMCY with the error code H8250 will be sent.

The value is a multiple of 1ms. The value 0 disables the event-timer.

→ For emergency error code, refer to Section 6.23

2. Object H1600 to H164F Sub-index H01 to H08: RPDO mapping parameter

The default mapping is to unsigned 16 bit objects.

→ Refer to Subsection 7.1.2

31 ... 16	15 ... 8	7 ... 0
Index	Sub-index	Length

Example:

To map the first unsigned 16bit data of RPDO1 to BFM0, set Index H1600 Sub-index H01 to HA5800110. This stands for Object Dictionary Index HA580, Sub-index H01 and a data size of 16bit.

Item	Description
Index	Index of the mapped Object
Sub-index	Sub-index of the mapped Object
Length	Bit length of the mapped Object

3. Object H1800 to H184F

1) Sub-index H01: TPDO COB-ID

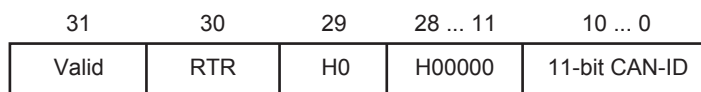

Bit No.	Item	Description
Bit 0 to 10	11-bit CAN-ID	11-bit CAN-ID of the CAN base frame → For COB-ID, refer to Subsection 5.6.1
Bit 11 to 28	-	Bit 11 to 28 fixed to OFF (0).
Bit 29	-	Bit 29 fixed to OFF (0).
Bit 30	RTR	OFF (0): Remote transmission request (RTR) allowed ON (1): Remote transmission request (RTR) not allowed This bit is constantly set to ON in the FX3U-CAN.
Bit 31	valid	OFF (0): Valid ON (1): Invalid

2) Sub-index H02: TPDO transmission type

Value (hex)	Description
00	Synchronous (acyclic) The PDO will be transmitted once (acyclic) after occurrence of the SYNC if an event occurred before the SYNC.
01	Synchronous (cyclic every SYNC)
02	Synchronous (cyclic every 2 nd SYNC)
03	Synchronous (cyclic every 3 rd SYNC)
⋮	⋮
F0	Synchronous (cyclic every 240 th SYNC)
F1 to FD	Reserved
FE	Event-driven (Function Mode 405)
FF	Event-driven (Function Mode 417)

3) Sub-index H03: TPDO inhibit time

This object configures the minimum time between two PDO transmissions if the transmission type is set to HFE or HFF. PDO transmission request over BFM #20 will be dismissed during this time. Unit of this value is 100 μs (FX3U-CAN counting resolution: 1 ms). The value 0 disables the inhibit time.

→ **For BFM #20, refer to Section 6.4**

4) Object H1800 to H184F Sub-index H05: TPDO event-timer

If the event timer elapses and an event driven transmission is not sent in that time (transmission type is set to HFE or HFF), a message will be sent with the current value of the Object dictionary. Unit of this value is ms. The value 0 disables the event-timer.

Note

If the inhibit time is active, no PDO will be transmitted.

1	Introduction
2	Specifications
3	Installation
4	Wiring
5	Introduction of Functions
6	Allocation of Buffer Memories
7	Interface and Device Profile (405 mode)
8	Lift Application Profile (417 Mode)
9	CAN Layer 2 Mode
10	Command Interface

4. Object H1A00 to H1A4F Sub-index H01 to H08: TPDO mapping parameter

The default mapping is to unsigned 16 bit objects.

→ Refer to Subsection 7.1.1

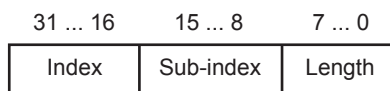

Example:

To map unsigned 16bit data of BFM0 to the first 16 bits of TPDO 1, set Index H1A00 Sub-index H01 to HA1000110.

This stands for Object Dictionary Index HA100, Sub-index H01 and a data size of 16bit.

Item	Description / set range
Index	Index of the mapped Object
Sub-index	Sub-index of the mapped Object
Length	Bit length of the mapped Object

Timing chart

The following figures show the relation between Transmit Process Data BFM's (BFM data), BFM #20 bit 0, PDO Inhibit time, PDO Event timer and CAN bus data in NMT state Operational for event driven PDO's. Note that the event and inhibit timer are started every time when PDO transmission is started.

Example 1: Inhibit time = 0, Event time = 0

The BFM data will be copied into the Object dictionary and a PDO will be sent every time when the data are changed and a data exchange is triggered. If the data are not changed, no PDO will be sent if a data exchange is triggered by BFM #20.

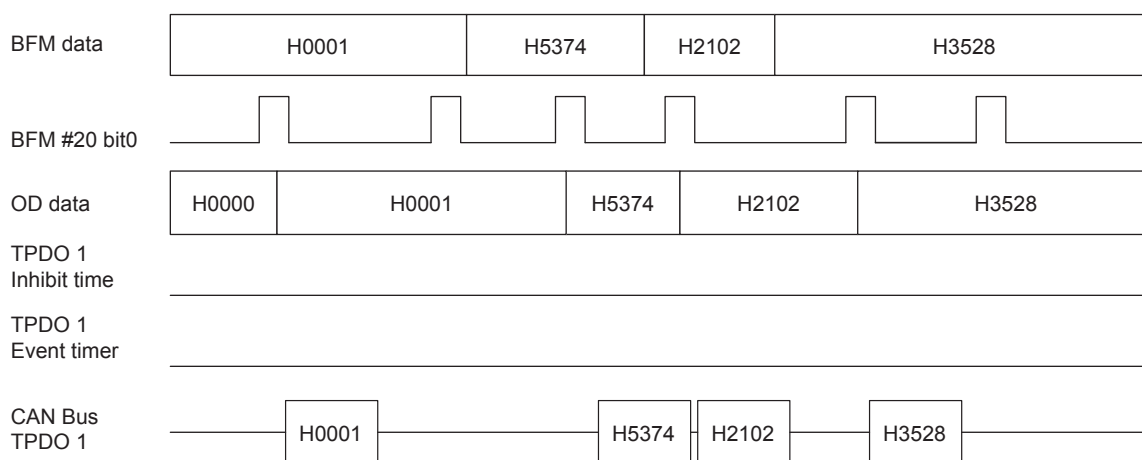

Example 2: Inhibit time > 0, Event time = 0

The BFM data will be copied into the Object dictionary and a PDO will be sent every time when the data are changed and the inhibit time is not running. If the inhibit time is active and the data are changed before the inhibit time elapsed, the former data will not be sent as PDO.

- Before FX3U-CAN firmware version 1.10
If the data are not changed, no PDO will be sent if a data exchange is triggered by BFM #20.
- FX3U-CAN firmware version 1.10 or later
If a data exchange is triggered by BFM #20 and at the last data exchange the inhibit time was active, a PDO will be sent, otherwise no PDO will be sent as long as the data did not change.

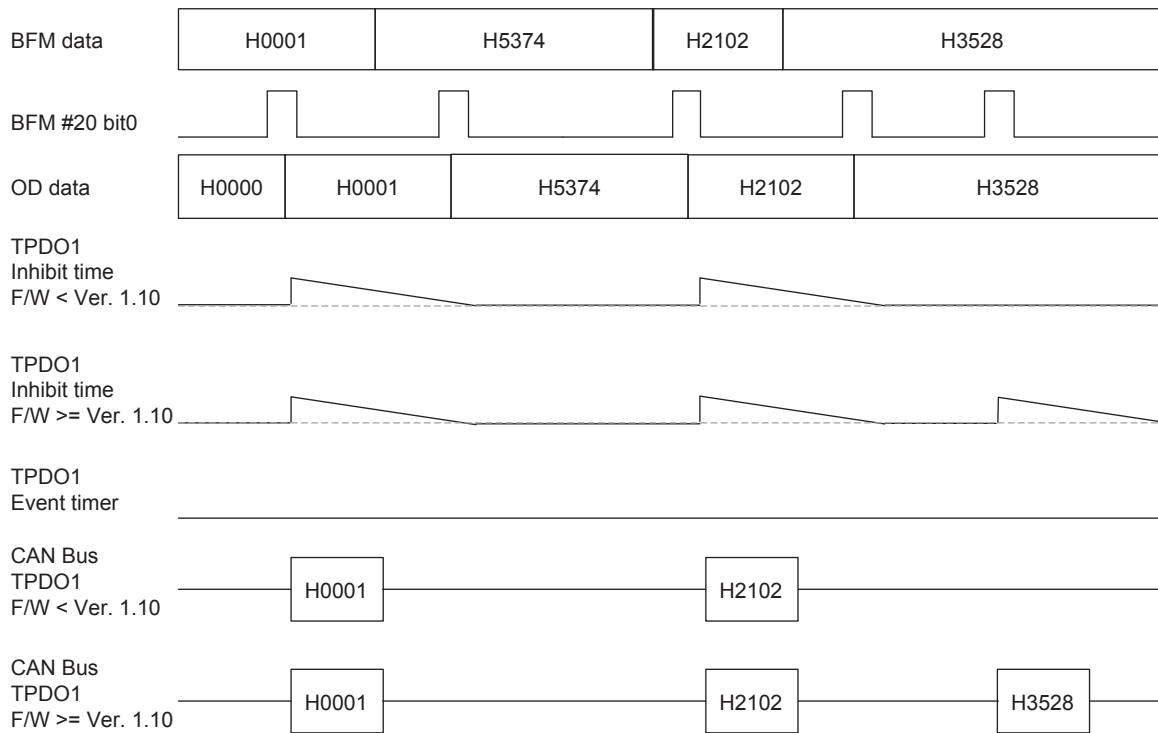

Example 3: Inhibit time = 0, Event time > 0

The BFM data will be copied into the Object dictionary and a PDO will be sent every time when the data are changed. Even if no data exchange with new data is triggered by BFM #20, a PDO with the actual object dictionary data will be sent when the event timer elapsed.

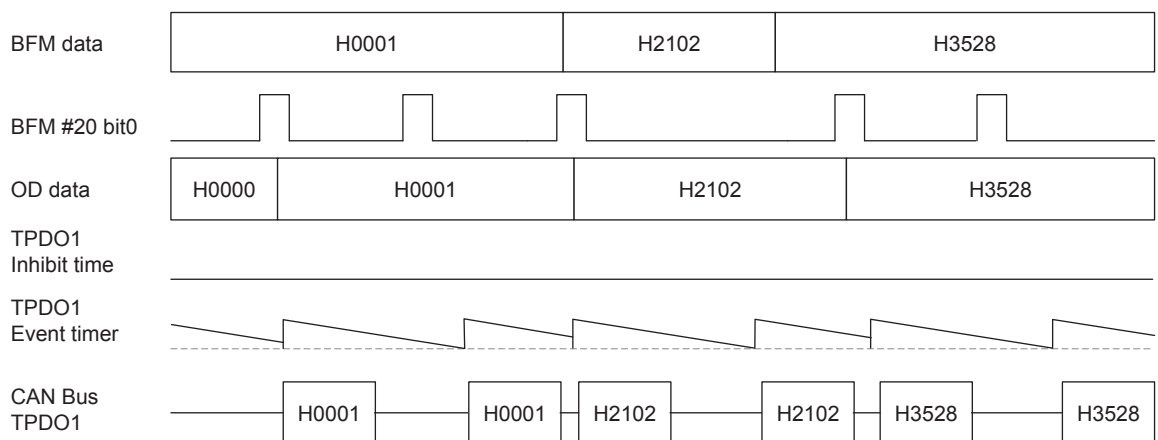

1 Introduction
2 Specifications
3 Installation
4 Wiring
5 Introduction of Functions
6 Allocation of Buffer Memories
7 Interface and Device Profile (405 mode)
8 Lift Application Profile (417 Mode)
9 CAN Layer 2 Mode
10 Command Interface

Example 4: Inhibit time > 0, Event time > 0, Inhibit time < Event time

The BFM data will be copied into the Object dictionary. A PDO will be sent every time when the data are changed and the inhibit time is not running. If the inhibit time is active and the data are changed before the inhibit time elapsed, the former data will not be sent as PDO.

- Before FX3U-CAN firmware version 1.10
If the data are not changed, no PDO will be sent if a data exchange is triggered by BFM #20.
- FX3U-CAN firmware version 1.10 or later
If a data exchange is triggered by BFM #20 and at the last data exchange the inhibit time was active, a PDO will be sent, otherwise no PDO will be sent as long as the data did not change.

If no data exchange with new data is triggered by BFM #20, a PDO with the actual object dictionary data will be sent when the event timer elapsed and the inhibit time is not active.

The inhibit time in combination with the event timer allows new PDO data to be sent without the need to retrigger the data exchange by BFM #20 for the case that during the first data exchange of new data the inhibit time was active.

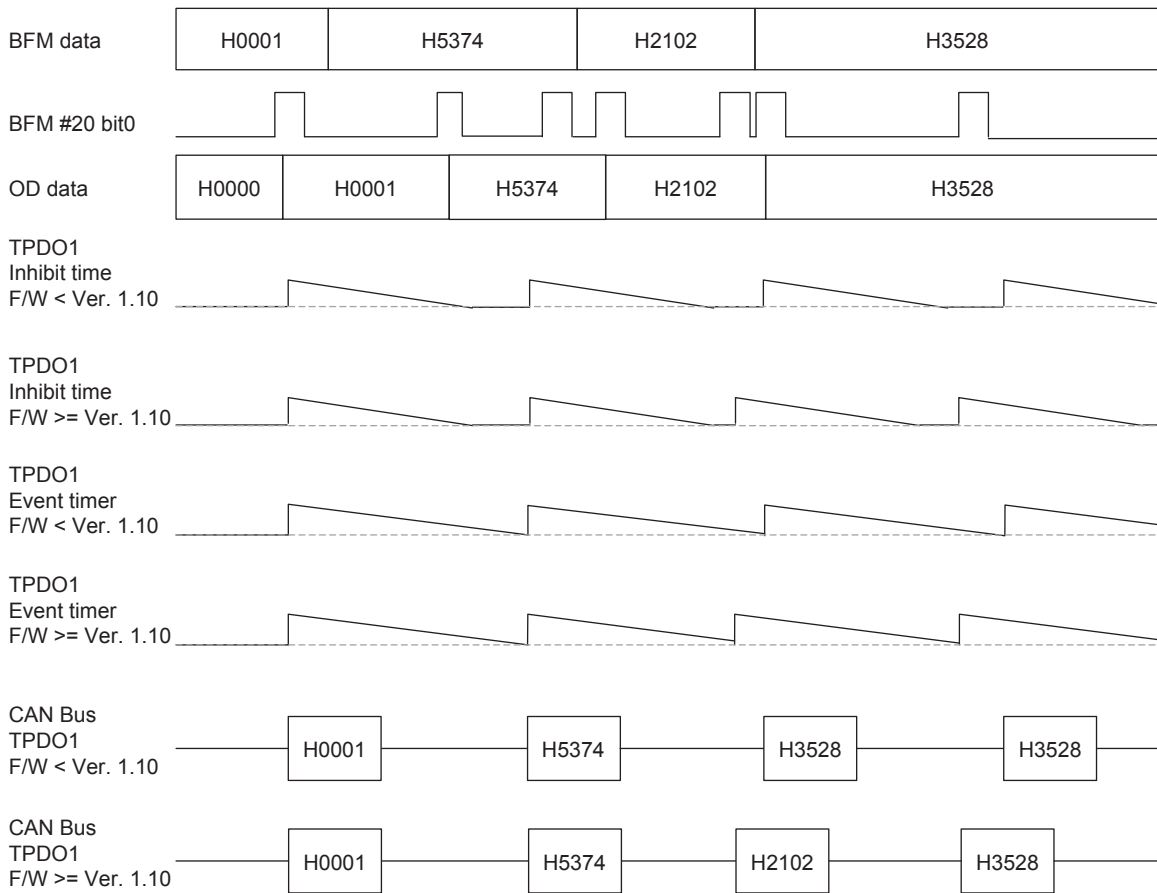

Example 5: Inhibit time > 0, Event time > 0, Inhibit time > Event time

The BFM data will be copied into the Object dictionary and a PDO will be sent every time when the data are changed and the inhibit time is not running. If the inhibit time is active and the data are changed before the inhibit time elapsed, the former data will not be sent as PDO.

If the data are not changed, no PDO will be sent if a data exchanged is triggered by BFM #20.

If no data exchange with new data is triggered by BFM #20, a PDO with the actual object dictionary data will be sent when the event timer elapsed and the inhibit time is not active. If the inhibit time is active the event timer starts running again without a PDO being sent.

The inhibit time in combination with the event timer allows new PDO data to be sent without the need to retrigger the data exchange by BFM #20 for the case that during the first data exchange of new data the inhibit time was active.

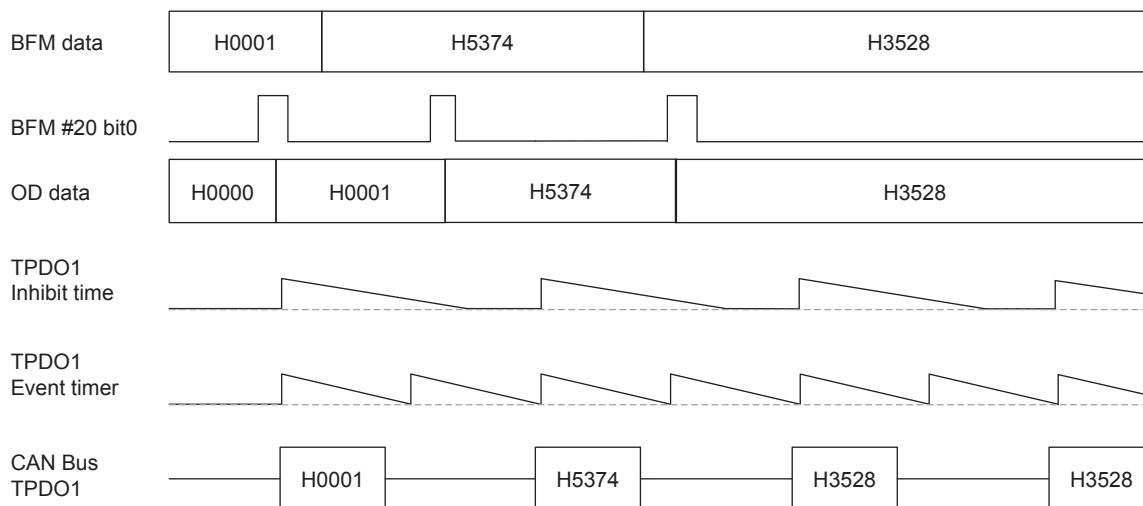

1	Introduction
2	Specifications
3	Installation
4	Wiring
5	Introduction of Functions
6	Allocation of Buffer Memories
7	Interface and Device Profile (405 mode)
8	Lift Application Profile (417 Mode)
9	CAN Layer 2 Mode
10	Command Interface

5.6.6 MPDO

A Multiplexed PDO, like an SDO, provides direct write access to objects of a CANopen[®] device's object dictionary. The size of the data of these objects is limited to a maximum of 4 bytes.

The MPDO service can only be used in the CiA[®] 417 Lift Application Mode and does not have to be configured.

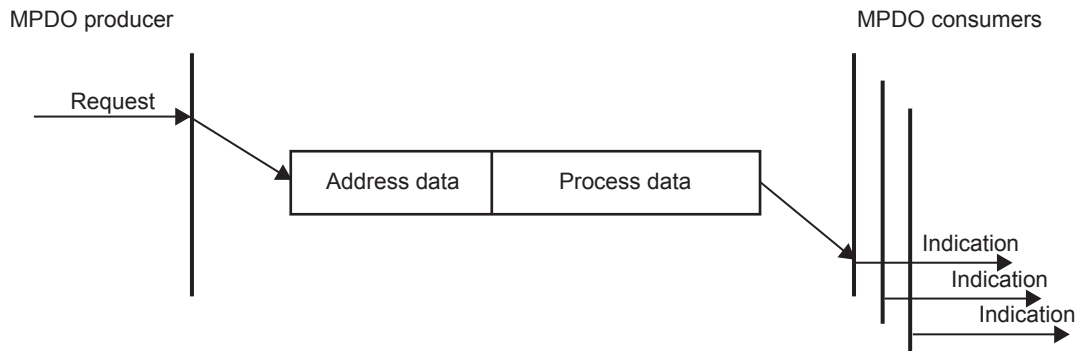

Process data:

Data less than 4 bytes is filled with H0 to make it 32 bits.

5.6.7 SYNC

The SYNC producer broadcasts the synchronization object periodically. The SYNC message provides the basic network synchronization mechanism. The time period between SYNC messages is specified by the standard parameter communication cycle period. There may be a time jitter in transmission by the SYNC producer corresponding approximately to the latency from some other message being transmitted just before the SYNC.

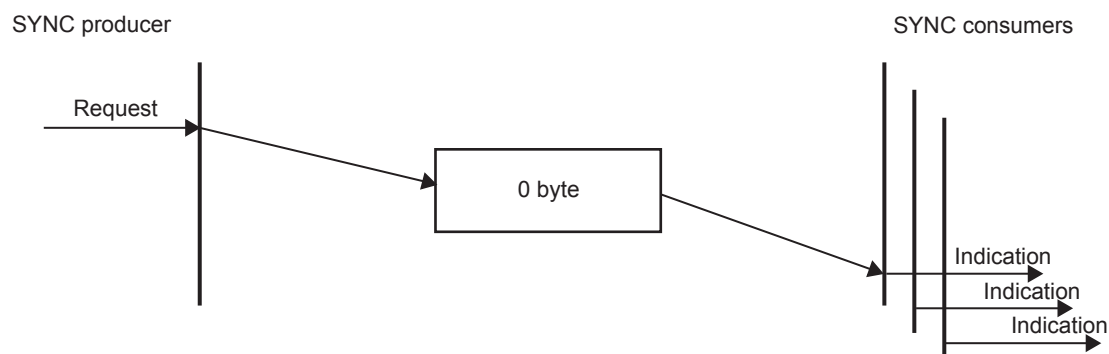

SYNC Object

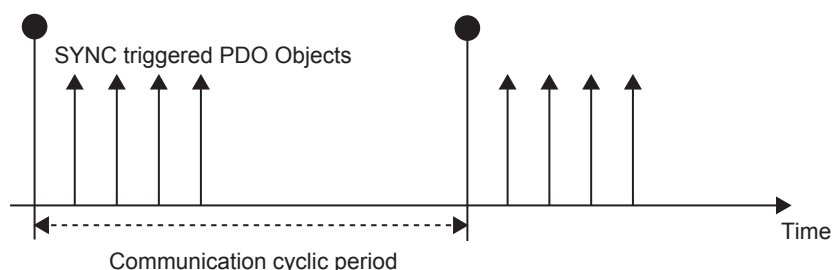

1. Object H1005: COB-ID SYNC message

In order to guarantee timely access to the network, the SYNC is given a very high priority CAN-ID.

→ For the COB-ID, refer to Subsection 5.6.1

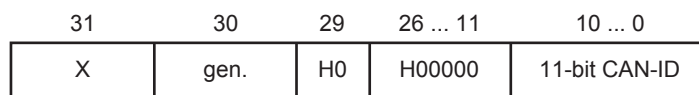

Bit No.	Item	Description / set range
Bit 0 to 10	11-bit CAN-ID	11-bit CAN-ID of the CAN base frame
Bit 11 to 28	-	Bit 11 to 28 fixed to OFF (0).
Bit 29	-	Bit 29 fixed to OFF (0).
Bit 30	gen.	OFF (0): Don't generate SYNC message ON (1): Generate SYNC message Note: <ul style="list-style-type: none"> • The device needs to be active NMT Master to produce SYNC messages. • The Index H1006 needs to be set to enable SYNC producing.
Bit 31	X	Do not care

2. Object H1006: Communication cycle period

This object provides the communication cycle period. This period defines the SYNC interval. The 32 bit value is in units of μs (FX3U-CAN counting resolution: 1 ms).

The FX3U-CAN counting resolution is 1ms, values smaller than 1ms will be set internally to 1ms, values starting from 1ms will be divided by 1000.

The value 0 disables SYNC producing. The module needs to be active NMT Master to produce SYNC messages.

Setting range: K0 to K4,294,967,295

→ For NMT Master, refer to Subsection 5.8.5

1	Introduction
2	Specifications
3	Installation
4	Wiring
5	Introduction of Functions
6	Allocation of Buffer Memories
7	Interface and Device Profile (405 mode)
8	Lift Application Profile (417 Mode)
9	CAN Layer 2 Mode
10	Command Interface

5.6.8 Node guarding

This protocol is used to detect remote errors in the network. Each NMT slave serves one requests message for the node guarding protocol.

The NMT master polls each NMT guarding slave at regular time intervals. This time-interval is called the guard time and may be different for each NMT slave. The response of the NMT slave contains the NMT state of that NMT slave. The node lifetime is given by guard time multiplied by lifetime factor. The node lifetime may be different for each NMT slave. If the NMT slave has not been polled during its lifetime, a remote node error is indicated through the NMT service life guarding event. A remote node error is indicated through the NMT service node guarding event if:

NMT master:

- The NMT master does not receive confirmation after the Guarding request within the node life time.
- The response of the NMT guarding slave state does not match the expected state.

NMT slave:

- The NMT guarding slave did not receive the NMT master Guarding request polling for time set in H100C and H100D.

If a remote error occurred previously but the errors in the guarding protocol have disappeared, it will be indicated that the remote error has been resolved through the NMT service node guarding event and the NMT service life guarding event.

If Heartbeat is activated, the Node guarding settings will be ignored.

Note

- As Slave, the FX3U-CAN (firmware Ver. 1.10 or later) supports Node Guarding. Use the heartbeat service for FX3U-CAN not supporting Node Guarding.
- Node guarding produces a high bus load. It is recommended to use heartbeat instead.

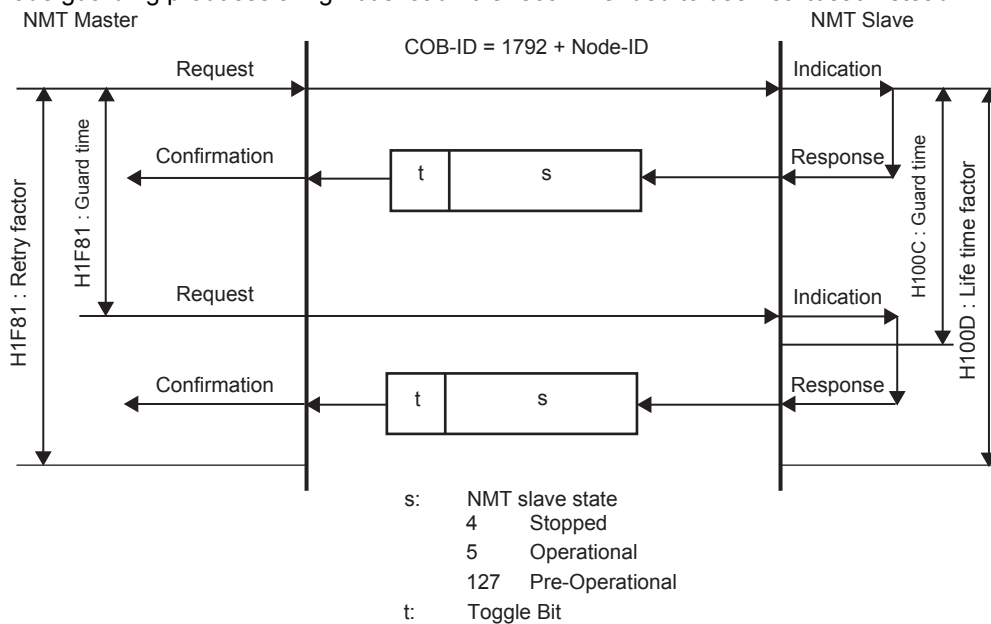

1. Slave Setting

- 1) Object H100C: Guard time
The 16bit guard time in units of ms is the time limit for which the response must be sent. The value 0 disables life guarding. Applicable for FX3U-CAN firmware Ver. 1.10 or later.
- 2) Object H100D: Life time factor
The 8bit life time factor value multiplied by the guard time gives the life time for which the NMT Master has to send the guarding request. The value 0 disables life guarding. Both Objects have to be set to activate Node guarding. The order in which Guard time and Life time factor are set does not matter. Applicable for FX3U-CAN firmware Ver. 1.10 or later.

2. Master Setting

- 1) Object H1F81: NMT slave assignment

→ Refer to Subsection 5.8.7

5.6.9 Heartbeat

The heartbeat protocol defines an error control service that does not use requests. A heartbeat producer transmits a heartbeat message cyclically. One or more heartbeat consumers receive the indication. The relationship between producer and consumer is configurable via the object dictionary. The heartbeat consumer guards the reception of the heartbeat within the heartbeat consumer time. If the heartbeat is not received within the heartbeat consumer time, a heartbeat event will be generated.

If the FX3U-CAN module is configured as Flying Master, Heartbeat producing and consuming is automatically activated between it and other FX3U-CAN modules also set up as Flying Masters.

→ **For Flying Master, refer to Subsection 5.8.11**

Note

Heartbeat produces a high bus load, but only half that of node guarding.

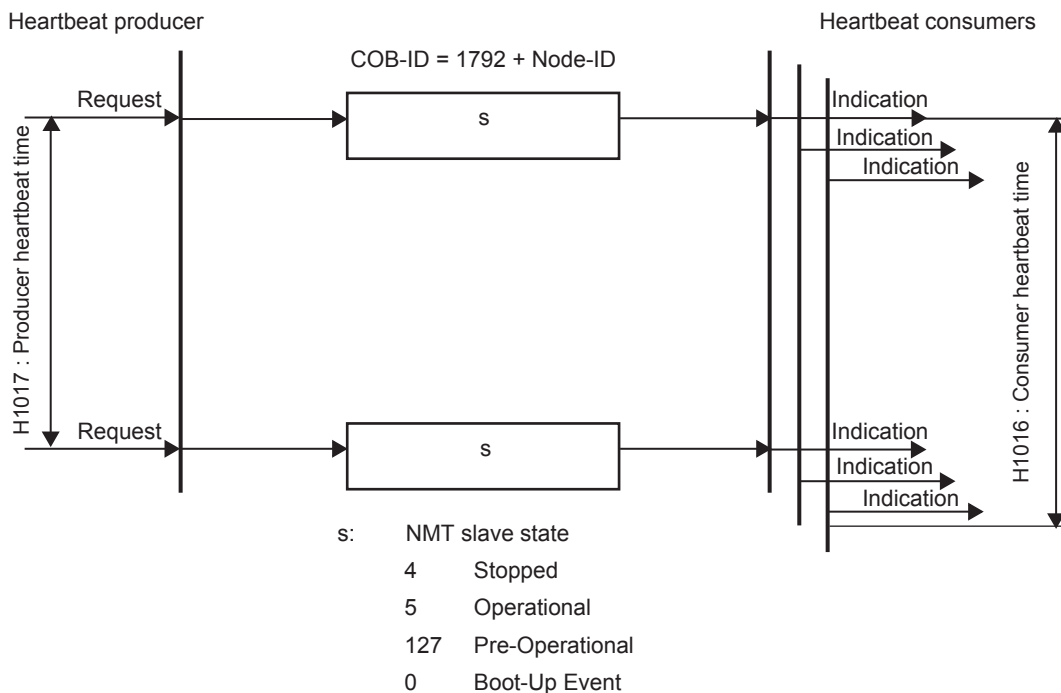

1. Object H1016 sub-index H01 to H7F: Consumer heartbeat time

The consumer heartbeat time object indicates the expected heartbeat cycle times. Monitoring of the heartbeat producer starts after reception of the first heartbeat. The consumer heartbeat time should be higher than the corresponding producer heartbeat time. Before reception of the first heartbeat, the status of the heartbeat producer is unknown.

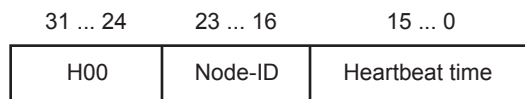

If the heartbeat time is 0 or the node-ID is 0 or greater than 127, the corresponding object entry is not used. The unit of heartbeat time is ms.

2. Object H1017: Producer heartbeat time

The unit of 16bit producer heartbeat time is ms. The value 0 disables the producer heartbeat.

1	Introduction
2	Specifications
3	Installation
4	Wiring
5	Introduction of Functions
6	Allocation of Buffer Memories
7	Interface and Device Profile (405 mode)
8	Lift Application Profile (417 Mode)
9	CAN Layer 2 Mode
10	Command Interface

5.6.10 TIME

The TIME producer broadcasts the time stamp object. This TIME provides the simple network clock. The time stamp contains the Time of day, which is represented by a 48 bit sequence. These sequences represent the time in milliseconds after midnight (28 bits) and the number of days since 1984-01-01 (16 bits). Only one Timestamp producer is allowed in the Network.

The time and the date have to be configured by setting BFM #51 to #57 (clock data).

In order to guarantee timely access to the network, the TIME is given a very high priority CAN-ID. CANopen® devices that operate a local clock may use the TIME object to adjust their own time base to that of the time stamp object producer.

The consuming and producing setting can be directly changed by BFM #50.

In case of time overflow (time later than 31st December 2099 23:59.59), the time returns to 1st January 2000 00:00:00. Buffer memory display for year will be 00 to 99 in all cases.

Note for TIME consuming: A received Time stamp before 1st January 2000 00:00.00 is set to 1st January 2000 00:00.00.

→ For time stamp BFM #50 to #59, refer to Section 6.19

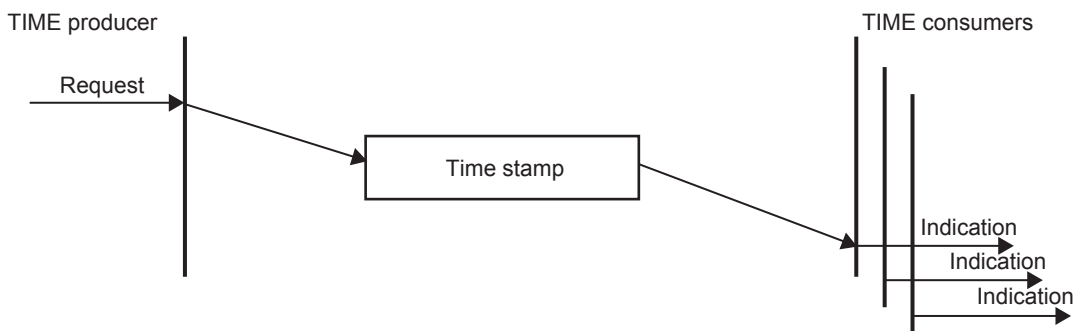

Object H1012: COB-ID time stamp object

→ For the resulting COB-ID, refer to Subsection 5.6.1

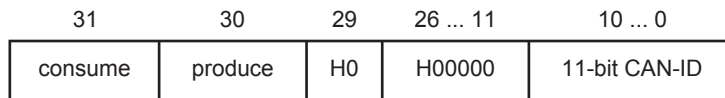

Bit No.	Item	Description
Bit 0 to 10	11-bit CAN-ID	11-bit CAN-ID of the CAN base frame
Bit 11 to 28	-	Bit 11 to 28 fixed to OFF (0).
Bit 29	-	Bit 29 fixed to OFF (0).
Bit 30	produce	OFF (0): Do not produce TIME Messages ON (1): Produce TIME Messages Note: The FX3U-CAN needs to be active NMT Master to produce TIME messages.
Bit 31	consume	OFF (0): Do not consume TIME Messages ON (1): Consume TIME Messages

5.6.11 Store parameters

To store all parameters to non-volatile memory, write SDO H65766173 (ISO8859 String code: "save") to Object Index H1010, Sub-Index H01 or use the store command in the CIF. After each power-up or reset, the saved parameters will be valid.

→ For the store command in the CIF, refer to Section 10.6

Note

For CDCF files stored on Object H1F22, the store parameter command is not necessary.

On read access, the CANopen® device gives back information about its storage functionality:

Bit No.	Description
Bit 0	OFF (0): Device does not save parameter on command. ON (1): Device saves parameter on command. (FX3U-CAN)
Bit 1	OFF (0): Device does not save parameter without user request. (FX3U-CAN) ON (1): Device saves parameter without user request.
Bit 2 to 31	Reserved

5.6.12 Restore default parameters

To restore factory default parameters, write SDO H64616F6C (ISO8859 code: daol ("load")) to Object Index H1011, Sub-Index H01 or use the restore command in the CIF. The stored parameters are then overwritten to factory default settings.

→ For the restore command in the CIF, refer to Section 10.7

Restore procedure:

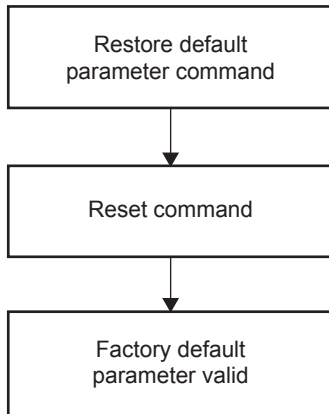

Note

- Do not execute a store parameter command before executing the reset command. Otherwise the factory default parameters will be overwritten with the previous settings.
- CDCF files stored on Object H1F22 will be also cleared and will be cleared directly before the Reset command.

On read access, the CANopen® device gives back information about its restoring functionality:

Bit	Description / set range
Bit 0	OFF (0): Device is not able to restore factory default parameters on command. ON (1): Device is able to restore factory default parameters on command. (FX3U-CAN)
Bit 1 to 31	Reserved

5.6.13 EMCY

Emergency objects are triggered by the occurrence of a CANopen® device internal error. An emergency object is transmitted only once per "error event." No further emergency objects are transmitted as long as no new errors occur on a CANopen® device. Zero or more emergency consumers may receive the emergency object. The received EMCY Messages will be displayed in BFM #750 to #859. A transmission of EMCY Messages is possible over the CIF.

→ For BFM #750 to #859 Emergency Message Buffer, refer to Section 6.23
→ For sending an CIF EMCY Message in the CIF, refer to Section 6.23

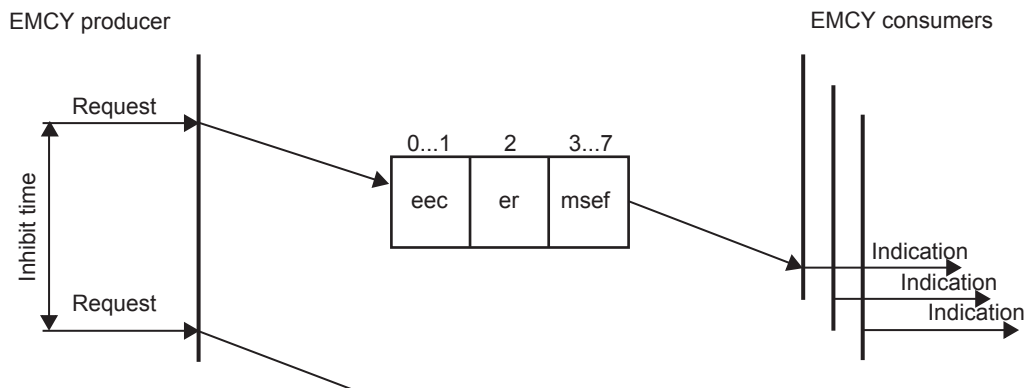

eec: Emergency error code (2 Byte)

er: Error register (1 Byte)

msef: Manufacturer-specific error code (5 Byte)

→ For Emergency error code, refer to Section 6.23

→ For Error register (object H1001), refer to Subsection 5.6.2

1 Introduction

2 Specifications

3 Installation

4 Wiring

5 Introduction of Functions

6 Allocation of Buffer Memories

7 Interface and Device Profile (405 mode)

8 Lift Application Profile (417 Mode)

9 CAN Layer 2 Mode

10 Command Interface

1. Object H1014: COB-ID EMCY

31	30	29	28 ... 11	10 ... 0
valid	H0	H0	H00000	11-bit CAN-ID

→ For the resulting COB-ID, refer to Subsection 5.6.1

Bit No.	Item	Description
Bit 0 to 10	11-bit CAN-ID	11-bit CAN-ID of the CAN base frame
Bit 11 to 28	-	Bit 11 to 28 fixed to OFF (0).
Bit 29	-	Bit 29 fixed to OFF (0).
Bit 30	-	Bit 30 fixed to OFF (0).
Bit 31	valid	OFF (0): EMCY producing is valid ON (1): EMCY producing is not valid

Note

On the FX3U-CAN, the setting is fixed and can not be changed.

2. Object H1015: Inhibit time EMCY

This object configures the minimum time between two EMCY messages. The unit of the 16 bit value is 100 μs. The value 0 disables the inhibit time.

The FX3U-CAN counting resolution is 1ms, values smaller than 1ms will set internally to 1ms, values starting from 1ms will be divided by 1000.

3. Object H1028 sub-index H01 to H7F: Emergency consumer object

This Object configures the COB-IDs for the EMCY objects that the module is consuming. The Sub-index refers to the related node-ID.

31	30	29	28 ... 11	10 ... 0
valid	H0	H0	H00000	11-bit CAN-ID

→ For the resulting COB-ID, refer to Subsection 5.6.1

Bit No.	Item	Description
Bit 0 to 10	11-bit CAN-ID	11-bit CAN-ID of the CAN base frame
Bit 11 to 28	-	Bit 11 to 28 fixed to OFF (0).
Bit 29	-	Bit 29 fixed to OFF (0).
Bit 30	-	Bit 30 fixed to OFF (0).
Bit 31	valid	OFF (0): EMCY consuming of remote Node is valid ON (1): EMCY consuming of remote Node is not valid

5.7 Error Behaviour

If a serious CANopen[®] device failure is detected in NMT state Operational, the CANopen[®] device automatically shifts to the NMT state Pre-operational by default. Alternatively, the CANopen[®] device can be configured to change to NMT state Stopped or remain in the current NMT state.

CANopen[®] device failures include the following communication errors:

- Bus-off conditions of the CAN interface
- Only as NMT Slave: Life guarding event with the state 'occurred' and the reason 'time out'
- Only as NMT Slave: Heartbeat event with state 'occurred' and the reason 'time out'
- PLC RUN → STOP: If the setting value is H01, the FX3U-CAN will change into Pre-operational but can be set again to Operational when the PLC is in STOP.
With the setting value H00 or H02, the FX3U-CAN can not set into Operational as long as the PLC is in STOP.
- FROM/TO Watchdog error: If the setting value is H01, the FX3U-CAN will change into Pre-operational but can be set again to Operational when the BFM #29 bit 7 is set.
With the setting value H00 or H02, the FX3U-CAN can not set into Operational as long as the BFM #29 bit 7 is set.

→ For FROM/TO Watchdog, refer to Section 6.9
→ For FROM/TO Watchdog error, refer to Section 14.2

Severe CANopen[®] device errors also may be caused by CANopen[®] device internal failures.

Object H1029 sub-index H01: Error behaviour object

Error class values

Value (hex)	Description
00	Change to NMT state Pre-operational (only if currently in NMT state Operational)
01	No change of the NMT state. Refer to different behaviour in case of PLC RUN → STOP.
02	Change to NMT state Stopped
03 to FF	Not used

1

Introduction

2

Specifications

3

Installation

4

Wiring

5

Introduction of Functions

6

Allocation of Buffer Memories

7

Interface and Device Profile (405 mode)

8

Lift Application Profile (417 Mode)

9

CAN Layer 2 Mode

10

Command Interface

5.8 Network Management

The NMT provides services for controlling the network behaviour of CANopen[®] devices. All CANopen[®] devices of a network referred to as NMT slaves are controlled by services provided by an NMT master. The NMT master is typically also the Application master at the same time, but it is not necessary. The FX3U-CAN supports the master functions NMT startup master, Flying master, Configuration manager, SYNC producer, TIME producer and LSS master which are described in the sections before and below.

5.8.1 CANopen[®] Boot-Up Procedure and NMT states

CANopen[®] devices shift to the NMT state Pre-operational directly after finishing device initialization. In this NMT state, CANopen[®] device parameterization and CAN-ID-allocation via SDO (e.g. using a configuration tool) is possible. Then the CANopen[®] devices may be switched directly or by the NMT startup master into the NMT state Operational.

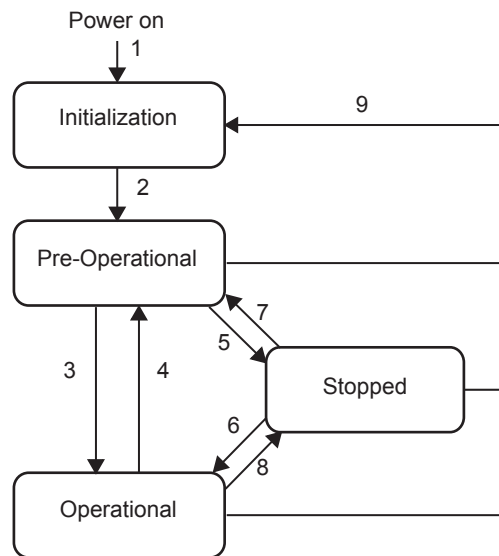

State Change	Description
1	At Power on, shifts to the NMT state initialization automatically.
2	After the NMT state initialization finishes, shifts to the "NMT state Pre-operational" automatically and sends a Boot-Up message → Refer to Subsection 5.8.2
3	NMT service start remote node indication
4, 7	NMT service enter pre-operational indication
5, 8	NMT service stop remote node indication
6	NMT service start remote node indication
9	NMT service reset node indication or reset communication indication

1. NMT state Pre-operational

In the NMT state Pre-operational, communication via SDO is possible. PDO communication is not allowed. Configuration of PDO, parameters and also the allocation of application objects (PDO mapping) may be performed by a configuration application. The CANopen[®] device may be switched into the NMT state Operational directly by sending the NMT service start remote node.

2. NMT state Operational

In the NMT state Operational, all communication objects are active.

3. NMT state Stopped

By switching a CANopen[®] device into the NMT state Stopped, it is forced to stop all communication. Furthermore, this NMT state may be used to achieve certain application behaviour.

4. NMT States and communication object relation

The relation between NMT states and communication objects is shown in the following table. Services in the listed communication objects may only be executed if the CANopen[®] devices involved in the communication are in the appropriate NMT states.

In case of trying to send a communication object which is not allowed in the specific NMT state, no error information will be displayed.

	Pre-operational	Operational	Stopped
PDO	-	✓	-
SDO	✓	✓	-
SYNC	✓	✓	-
EMCY	✓	✓	-
TIME	✓	✓	-
Node control and error control	✓	✓	✓

5.8.2 Protocol Boot-Up

This protocol is used to signal that a NMT slave has switched to the NMT state Pre-operational after the NMT state Initialization. The protocol uses the same CAN-ID as the error control protocols. One data byte is transmitted with value 0.

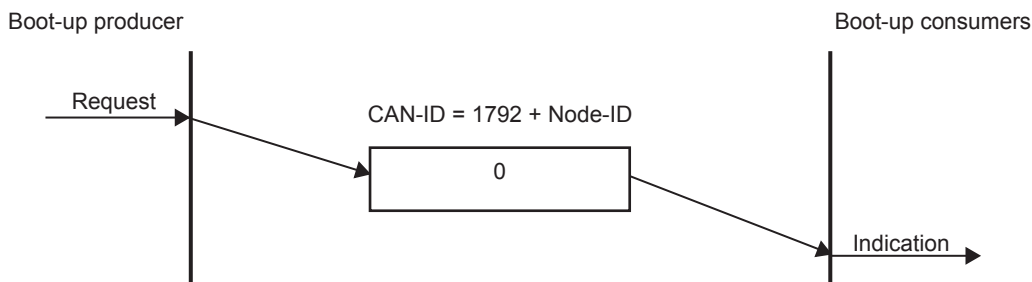

5.8.3 Protocol NMT (Node control)

This Protocol is used by the NMT Master to control the NMT state of remote Nodes. Producing is allowed only by the NMT Master.

If the module is the active NMT master, the module is ignoring NMT messages with the Node-ID 0 (All Nodes).

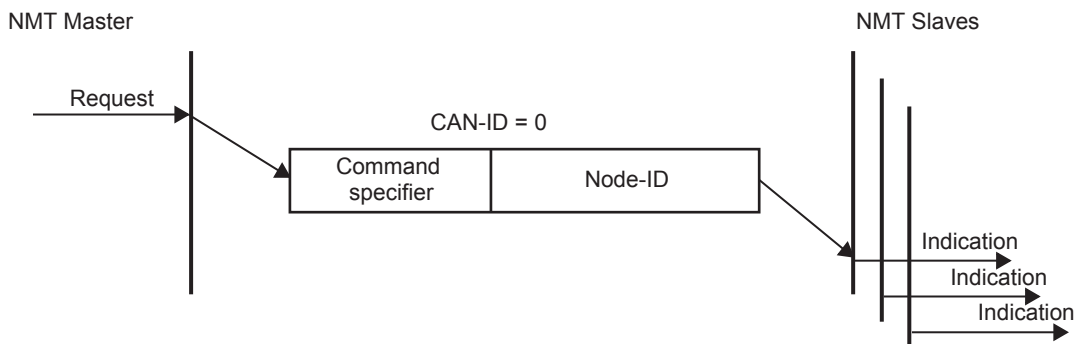

Command specifier (1 byte)

- 1 Start
- 2 Stop
- 128 Pre-Operational
- 129 Reset Application
- 130 Reset Communication

Node-ID (1 byte)

- 0 All Nodes
- 1 to 127 Selected Node

- 1 Introduction
- 2 Specifications
- 3 Installation
- 4 Wiring
- 5 Introduction of Functions
- 6 Allocation of Buffer Memories
- 7 Interface and Device Profile (405 Mode)
- 8 Lift Application Profile (417 Mode)
- 9 CAN Layer 2 Mode
- 10 Command Interface

5.8.4 NMT slave identification

The NMT startup master and the LSS master are using the NMT slave identification data to identify the NMT slave before configuring the NMT slave.

If the configured identification data on the NMT master are different than responded from the NMT slave, the NMT startup master service will stop the startup of this NMT slave.

The Sub-index corresponds to the NMT slave Node-ID. The default value 0 has the meaning not configured, and the NMT master will skip this entry.

For the LSS Master all NMT slave Identification data need to be configured! For the NMT Startup Master, the NMT slave identification entries are optional.

1. Object H1F84 Sub-index H01 to H7F: Device Type

The sub-index corresponds to the Node-ID.

The value refers to the object H1000 sub-index 00 of the corresponding Node-Id.

2. Object H1F85 Sub-index H01 to H7F: Vendor identification

The sub-index corresponds to the Node-ID.

The value refers to the object H1018 sub-index 01 of the corresponding Node-Id.

3. Object H1F86 Sub-index H01 to H7F: Product code

The sub-index corresponds to the Node-ID.

The value refers to the object H1018 sub-index 02 of the corresponding Node-Id.

4. Object H1F87 Sub-index H01 to H7F: Revision number

The sub-index corresponds to the Node-ID.

The value refers to the object H1018 sub-index 03 of the corresponding Node-Id.

5. Object H1F88 Sub-index H01 to H7F: Serial number

The sub-index corresponds to the Node-ID.

The value refers to the object H1018 sub-index 04 of the corresponding Node-Id.

5.8.5 NMT master startup

The NMT startup master behaves according to the NMT state machine as defined in Subsection 5.8.1. Before the NMT master transitions from NMT state Pre-operational to NMT state Operational, all assigned NMT slaves shall be booted.

The Main flow chart for the NMT master startup is shown in Figure 5.1

Figure 5.2 is a simple startup overview to show the influence of the BFM #70 setting. It is recommended not to use the simple startup because it can not be guaranteed that every NMT Slave will be set into Operational state. Setup the NMT slave startup values for every connected NMT slave on the NMT master instead.

→ For NMT slave startup, refer to Subsection 4.7.6

Figure 5.1: NMT Master startup process

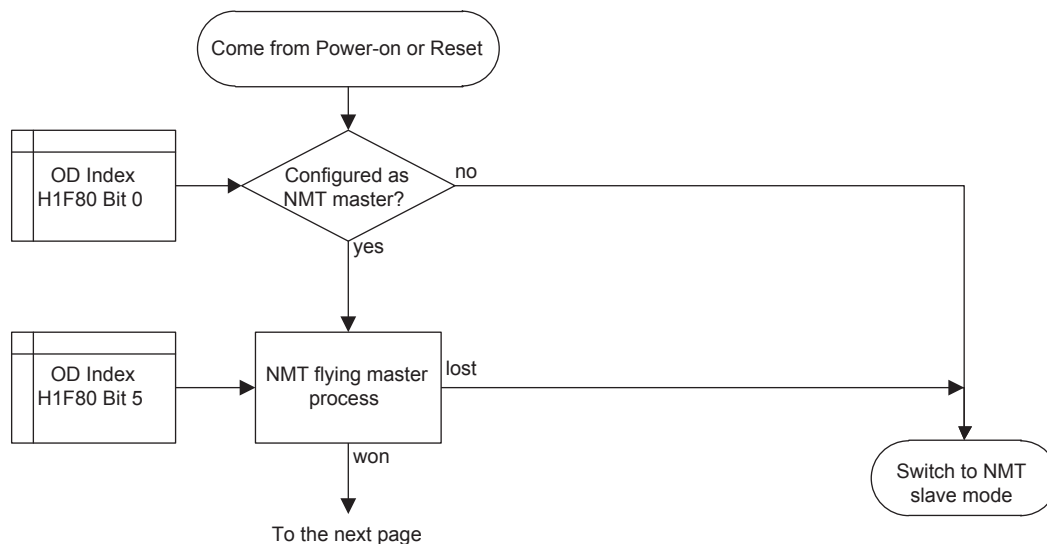

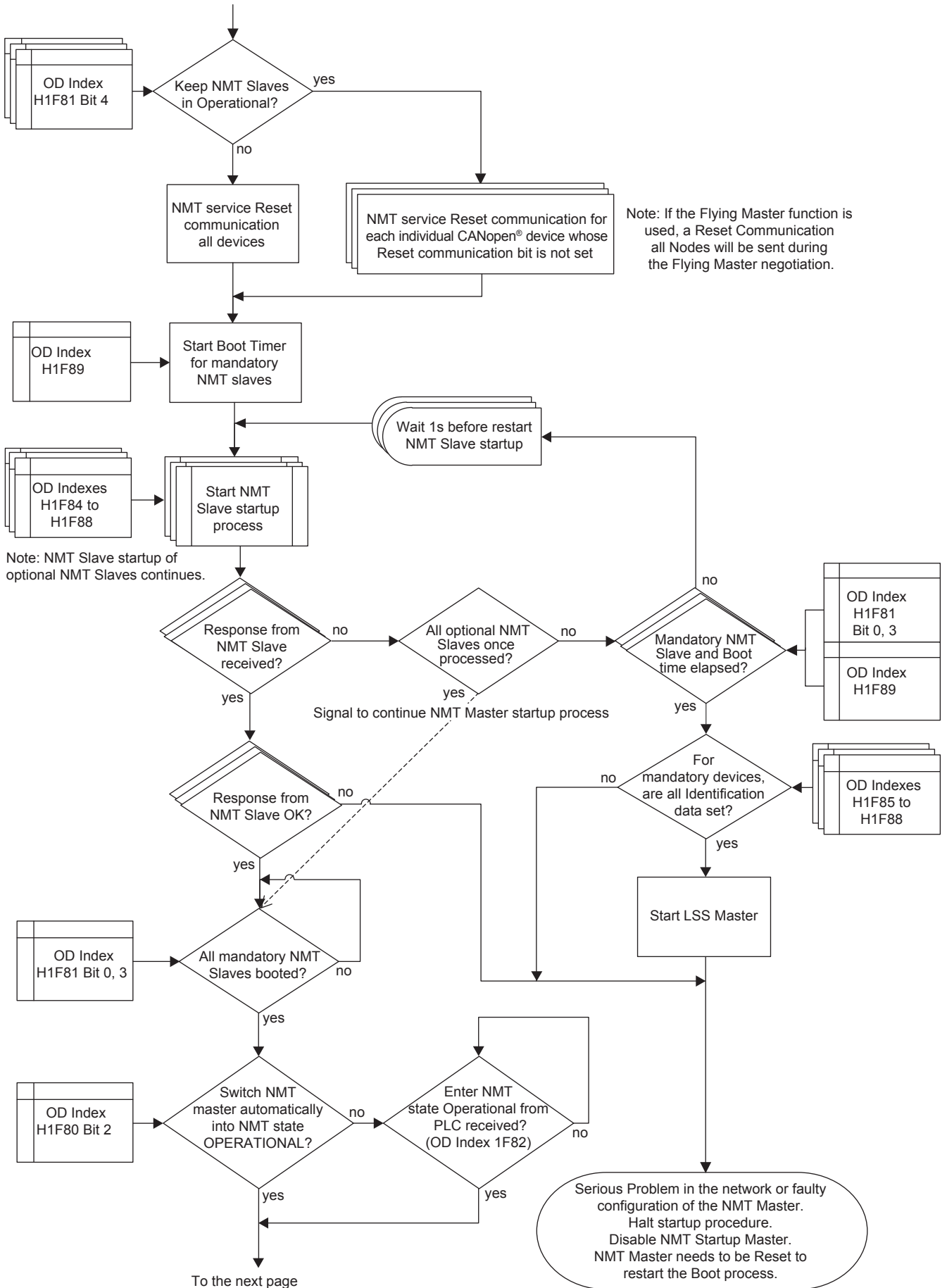

1	Introduction
2	Specifications
3	Installation
4	Wiring
5	Introduction of Functions
6	Allocation of Buffer Memories
7	Interface and Device Profile (405 mode)
8	Lift Application Profile (417 Mode)
9	CAN Layer 2 Mode
10	Command Interface

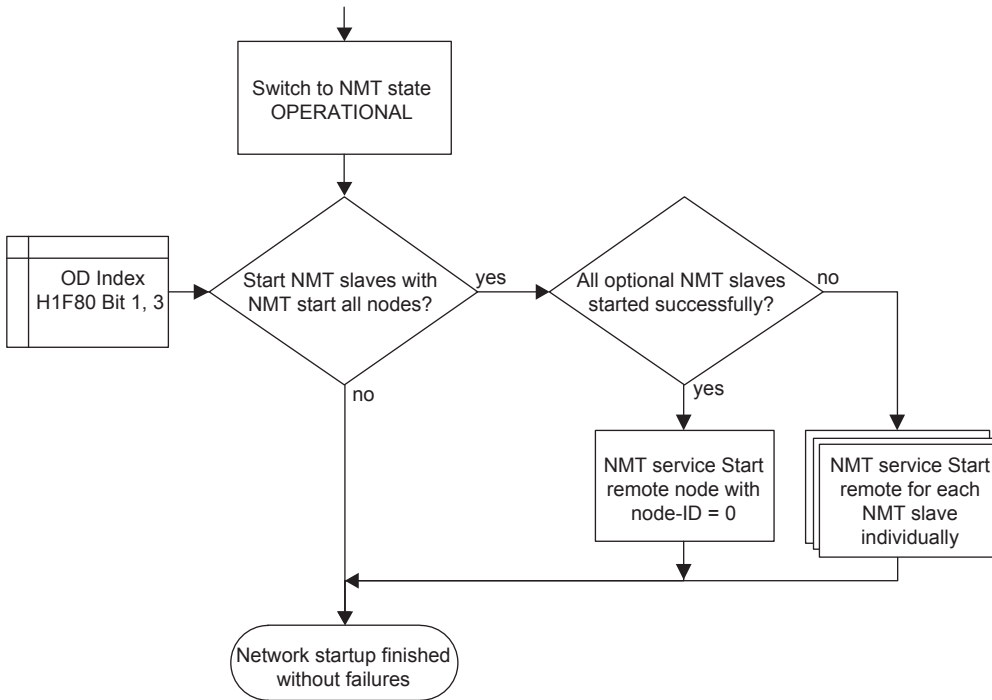
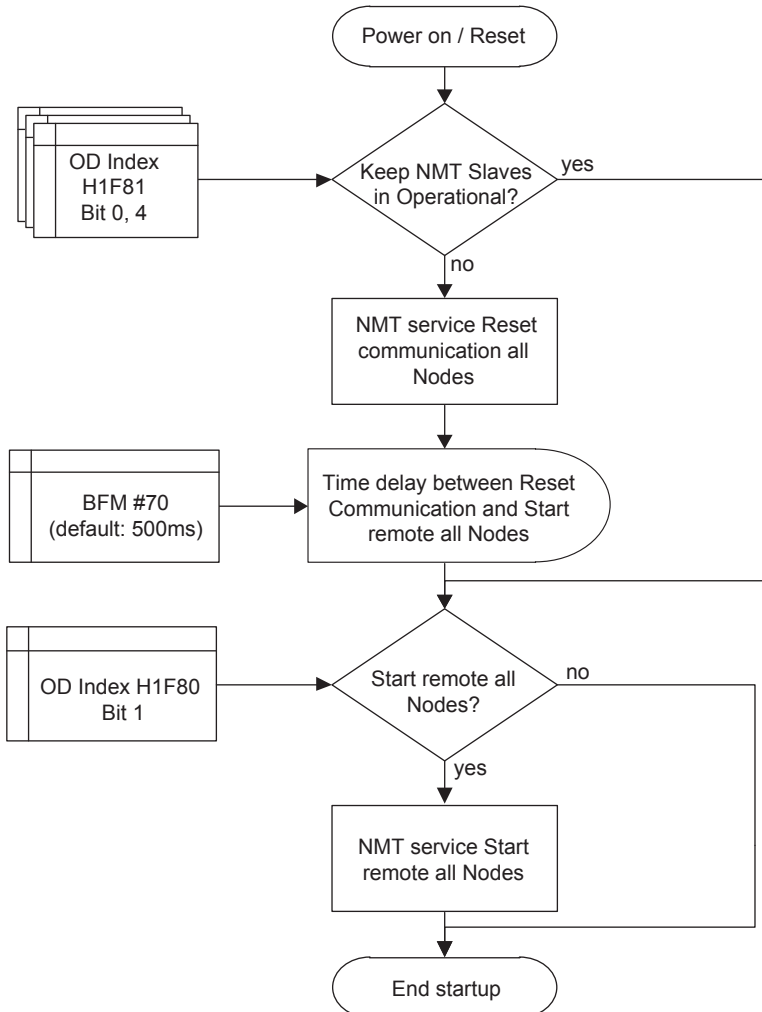

Figure 5.2: NMT Master simple startup

This overview is a more simple overview of the total NMT master startup without any NMT Slave setting in Object Dictionary Index H1F81. Refer to the other figure to see the whole process.



Object H1F80: NMT startup

This object configures the start up behaviour of a CANopen[®] device via SDO access. If the node is set as Master without the flying master capability, the node starts as NMT master and ignores "all Nodes" NMT commands from the network. After the FX3U-CAN has been configured as the NMT master, parameters have to be stored, and the FX3U-CAN has to be restarted by BFM #25 bit 0 or NMT request Reset Node.

→ For storing parameters, refer to Subsection 5.6.11
→ For module restart (BFM #25 bit 0), refer to Section 6.8

31...7	6	5	4	3	2	1	0
H0	Stop all nodes	Flying master	Reset all nodes	Start nodes	NMT master start	Start all nodes	NMT master

Bit No.	Item	Description
Bit 0	NMT master	OFF (0): Module is NMT Slave ON (1): Module is NMT Master Note: • If it's set to 0, all other settings of Object H1F80 and H1F81 are ignored. • In a CANopen [®] network, only one (active) NMT Master allowed!
Bit 1	Start all nodes	OFF (0): NMT master sends during the NMT startup the NMT service Start remote node for each assigned NMT slave. The NMT slaves will be started during the NMT startup individually. ON (1): NMT master sends during the NMT startup the NMT service Start all remote nodes. The NMT slaves will be started during the NMT master startup all at the same time. Notes if setting is ON (1): • Note Figure 5.2 NMT Master simple startup. • Don't use this setting to start remote nodes which are not assigned to the master via Index H1F81. → Refer to Subsection 5.8.6
Bit 2	NMT master start	OFF (0): NMT Master switch during NMT master startup automatically into NMT state Operational ON (1): NMT Master does not switch during NMT master startup automatically into NMT state Operational Notes if setting is ON (1): The NMT Master has to be set manually with the SDO write command in the CIF over the Object H1F82 into NMT state Operational. The startup process will be suspended as long as the Device is not set into NMT State Operational. → Refer to Section 10.2
Bit 3	Start node	OFF (0): The NMT master shall start the NMT slaves. ON (1): The NMT master shall not start the NMT slaves and the PLC application may start the NMT slaves. Notes if setting is ON (1): Note the resulting behaviour shown in Figure 5.2 NMT Master simple startup and Figure 5.3 NMT Slave startup process.
Bit 4	Reset all nodes	OFF (0): In case of error control event of an assigned NMT slave defined as mandatory, the NMT service reset communication with node-ID of the CANopen [®] device that caused the error control event shall be executed. ON (1): In case of error control event of an assigned NMT Slave defined as mandatory, the NMT service reset communication all Nodes shall be executed. → Refer to Subsection 5.8.6 Note: • In case of optional NMT Slaves, the NMT service reset communication with node-ID of the CANopen [®] device that caused the error control event will always be executed. • If bit 6 is set to 1, this bit setting will be ignored for mandatory NMT slaves.
Bit 5	Flying master	OFF (0): Do not use Flying master service. ON (1): Use Flying master service Note: • If the device loses the Flying Master negotiation, the device works as NMT slave. • If the Flying Master Service is used, all NMT Master in the network need to be set as Flying Master! • If the setting is 1, additional settings need to be considered. → Refer to Subsection 5.8.11
Bit 6	Stop all nodes	OFF (0): Do not Stop all nodes in case of an NMT error control event of an assigned Mandatory NMT Slave ON (1): Stop all nodes in case of an NMT error control event of an assigned Mandatory NMT Slave Note: • If the setting is 1, the bit 4 setting is ignored. • To restart the network, the NMT master has to be reset manually with BFM #25 bit 0 or with the SDO write command in the CIF over the Object H1F82 into NMT state Reset Communication or Application all Nodes. → Refer to Section 6.8 and Section 10.2
Bit 7 to 31		-

1	Introduction
2	Specifications
3	Installation
4	Wiring
5	Introduction of Functions
6	Allocation of Buffer Memories
7	Interface and Device Profile (405 mode)
8	Lift Application Profile (417 Mode)
9	CAN Layer 2 Mode
10	Command Interface

5.8.6 NMT slave startup

If the NMT Master shall startup the NMT Slave, the NMT startup Master uses the Indexes H1F84 to H1F88 to identify the NMT Slaves during Boot-up. The Setting of these Indexes is optional.

The NMT startup Master will request the Index H1000 of the NMT slave to check if the NMT Slave is available in the network. If there is no response on the request, the NMT Master retries every 1s after the request until the NMT Slave responds to the request or the boot time for a mandatory Slave elapses without response.

The Index H1F89 Boot time shall be set to a value which is higher than the maximum NMT startup time of the slowest mandatory slave. This time has to be measured from Power-on/Reset of the NMT master to the point where the last mandatory slave becomes NMT state Operational.

If identification data of NMT Slaves do not match with the setting on the NMT Master, it will result in a termination of the whole NMT Startup process and the NMT startup Master will be disabled.

After a successful Identification, the Configuration Manager configures the NMT Slave at the time when configuration data are stored on the NMT Master.

At last depending on the setting, the NMT Master sets the NMT Slave into NMT state Operational.

→ For NMT Slave identification, refer to Subsection 5.8.4

→ For NMT Master startup process, refer to Figure 5.1

→ For Configuration Manager, refer to Subsection 5.8.13

Note

For correct functioning of the CANopen® network, it is recommended to assign all CANopen® devices which are NMT Slave to the NMT Master.

Figure 5.3: NMT Slave startup process

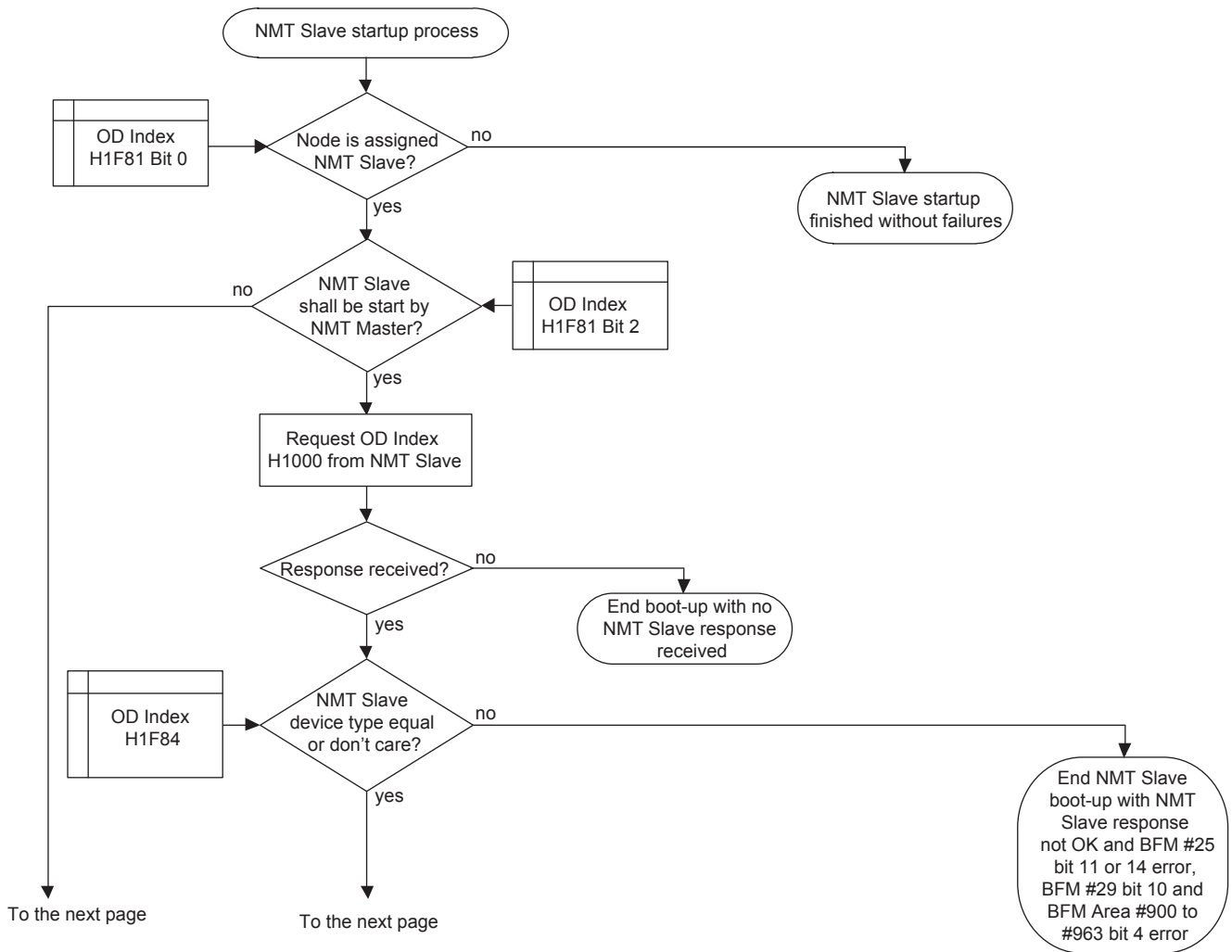

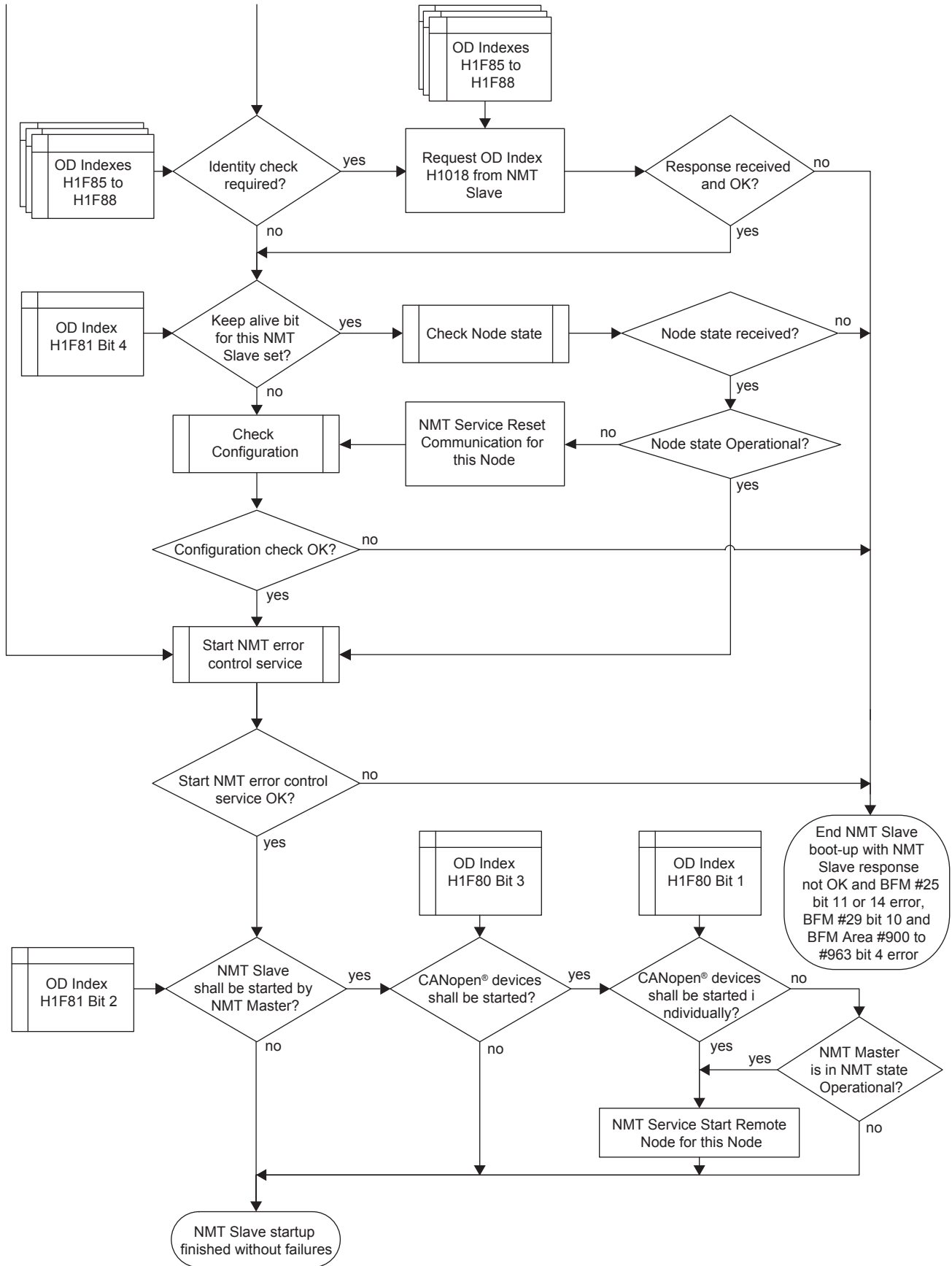

1	Introduction
2	Specifications
3	Installation
4	Wiring
5	Introduction of Functions
6	Allocation of Buffer Memories
7	Interface and Device Profile (405 mode)
8	Lift Application Profile (417 Mode)
9	CAN Layer 2 Mode
10	Command Interface

5.8.7 NMT slave assignment

This object configures on the NMT Master for each node-ID (corresponding to the sub-index), the node guarding values and the NMT Slave Configuration. Each sub-index of this object corresponds to the node-ID of a CANopen[®] device in the network. The sub-index which corresponds to the node-ID of the NMT Master is ignored.

1. Object H1F81 Sub-index H01 to H7F: NMT slave assignment

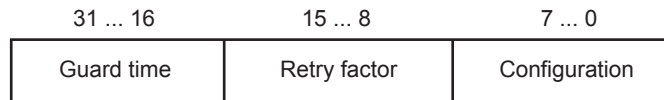

- 1) Guard time field:
The value for the guard time indicates the cycle time for node guarding of the CANopen[®] device. The value is in units of ms. The value 0 disables Node Guarding for the CANopen[®] device. Bit 0 in the Configuration field and the Retry factor needs to be set also to enable node guarding. If the heartbeat consumer object is configured to a value ≠ 0, then the heartbeat mechanism will have priority over node guarding.
Setting range: K0 to K65535
- 2) Retry factor field
The value for the retry factor indicates the number of retries the NMT master issues in case of a Node Guarding event. The value 0 disables Node Guarding for the CANopen[®] device. Bit 0 in the Configuration field and the Guardtime needs to be set also to enable node guarding.
Setting range: K0 to K255
- 3) Configuration field:

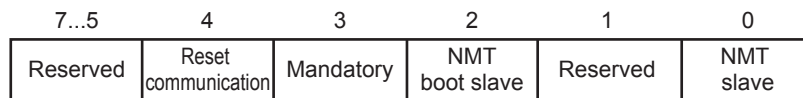

Bit No.	Item	Description
Bit 0	NMT slave	OFF (0): Remote Node is NMT Master or not assigned. ON (1): Remote Node is NMT Slave and assigned to this NMT Master. Note: <ul style="list-style-type: none"> It's mandatory to set this bit if the NMT Master shall startup and/or Node guard the NMT Slave. If the Flying Master Service is used, it shall be considered as Flying Master switching into NMT Slave mode if they are not the active NMT Master and may need to be startup by the active NMT Master. <p style="text-align: right;">→ Refer to Subsection 5.8.11</p>
Bit 2	NMT boot slave	OFF (0): Configuration and NMT service Start remote node are not allowed in case of error control event or NMT service Boot up. ON (1): Configuration and NMT service Start remote node execute in the case of error control event or NMT service Boot up. <p style="text-align: right;">→ Refer to Subsection 5.8.1, 5.8.2 and 5.8.13</p>
Bit 3	Mandatory	OFF (0): CANopen [®] device may be present prior to network start up (CANopen [®] device is optional) ON (1): CANopen [®] device is present prior to network start up (CANopen [®] device is mandatory) Note: <ul style="list-style-type: none"> For mandatory slaves consider at Object H1F80 also the bits 4 and 6 For LSS Slave this bit has to be set to 1 to enable LSS service for this NMT Slave. <p style="text-align: right;">→ Refer to Subsection 5.8.5</p>

Bit No.	Item	Description
Bit 4	Reset communication	<p>OFF (0): NMT service Reset communication may be executed for the CANopen® device at any time</p> <p>ON (1): NMT service Reset communication is not executed for the CANopen® device in case the CANopen® device is in NMT state Operational</p> <p>Note when using this function:</p> <ul style="list-style-type: none"> • If the Flying Master Service is used in the Network, there will be an all Node Reset communication command executed during the Flying Master negotiation Process • If no Heartbeat consuming is configured for this node, the NMT startup Master starts with Node Guarding, which has to be answered within 100ms. • In the case that no Heartbeat is used or supported, confirm that the NMT Slave supports Node guarding. • Take care that the NMT Master is also configured for Node Guarding if the NMT Slave is configured for life guarding of the NMT Master. Otherwise the NMT Slave will go in an NMT error state. • If within the Heartbeat consuming time no Heartbeat is received or no Node Guard confirmation is received after the Node Guarding RTR message, the NMT Slave startup ends with an error.
Bit 1, Bit 5 to 7	Reserved	<p>Default value: 0.</p> <p>If set to ON (1), FX3U-CAN will respond with SDO access error.</p>

2. Object H1F89 : Boot time

The object defines the time out in ms between start of the process Start process boot NMT slave and signalling of successful boot of all mandatory NMT slaves. If the Boot time elapses before all mandatory Slaves are started, the NMT startup will be stopped and the NMT startup Master will be disabled.

The value 0 disables the timer.

Setting range: K0 to K4,294,967,295

3. Object H102A: NMT inhibit time

This object configures the minimum time between two NMT messages. The 16bit value is given in multiples of 100 µs (Lowest counting resolution of FX3U-CAN: 1ms). The value 0 disables the inhibit time.

Setting range: In the FX3U-CAN, the value is fixed to 0.

1

Introduction

2

Specifications

3

Installation

4

Wiring

5

Introduction of Functions

6

Allocation of Buffer Memories

7

Interface and Device Profile (405 mode)

8

Lift Application Profile (417 Mode)

9

CAN Layer 2 Mode

10

Command Interface

5.8.8 NMT Bootup / Error Event handling

When Consumer Heartbeat time elapses, Node Guarding failed or the NMT Slave responds a unexpected Node state, the NMT Master handles the NMT Slave as shown in Figure 5.4.

If the NMT Master receives at any time a Boot-Up message from an assigned NMT Slave, the NMT Slave will be startup by the NMT startup Master. If the NMT Master is in NMT state stopped, the NMT startup Master will not be able to start the NMT Slave.

→ For protocol boot-up, refer to Subsection 5.8.2

Figure 5.4: NMT error handler

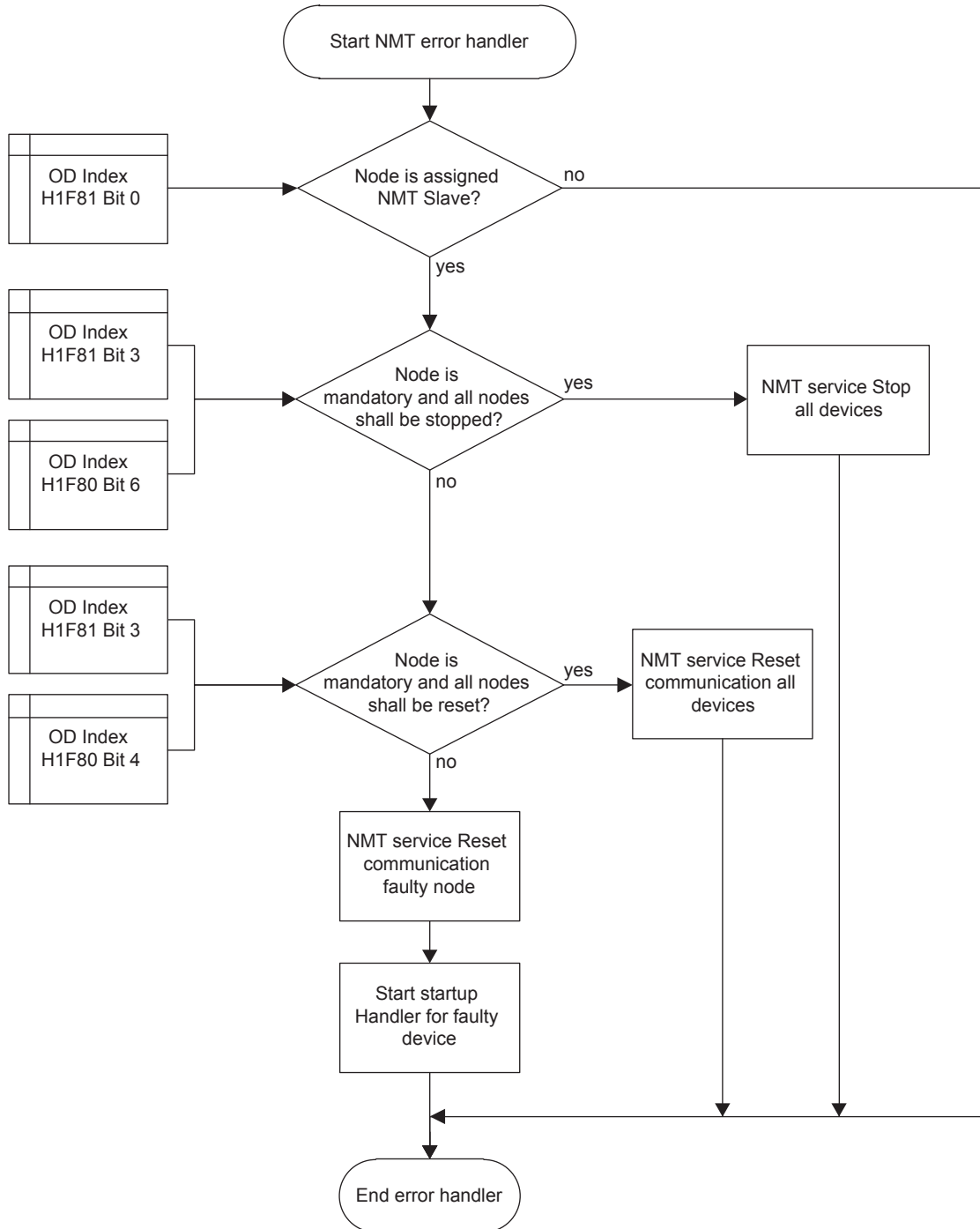

5.8.9 Request NMT

This object indicates at the NMT Master the current NMT state of a unique CANopen[®] device in the network. The sub-index corresponds to the node-ID of the CANopen[®] devices in the network. The sub-index H80 represents all nodes. Only the NMT Master is allowed to send NMT node control messages.

The NMT state is shown in BFM #601 to #727.

At the NMT Master, an NMT message can be requested can be via an SDO write access. Consider using this carefully because the NMT Startup Master will not set the Target Node automatically back to Operational until the next reset if the request is a Stop or Pre-Operational request!

→ For the BFM assignment corresponding to the NMT state of each node, refer to Section 6.22

Note

If a Node for Heartbeat consuming is activated and a boot-up Message is received from this node, the NMT state Pre-operational will be displayed for this node until the next Heartbeat is received for this node.

Object H1F82 Sub-index H01 to H80: Request NMT

Value (hex)	Description	
	SDO read	SDO write
00	NMT state unknown	Reserved
01	CANopen [®] device missing	Reserved
02 to 03	Reserved	
04	NMT state Stopped	NMT service Stop remote node
05	NMT state Operational	NMT service Start remote node
06	Reserved	NMT service Reset node
07	Reserved	NMT service Reset communication
08 to 7E	Reserved	
7F	NMT state Pre-operational	NMT service Enter pre-operational
80 to 83	Reserved	
84	Reserved	NMT service Stop remote node excluding NMT master With this Value the NMT Slave will be set into the requested NMT State Stopped, but the NMT Master will stay in its current NMT State.
85	Reserved	NMT service Start remote node excluding NMT master With this Value the NMT Slave will be set into the requested NMT State Operational, but the NMT Master will stay in its current NMT State.
86	Reserved	NMT service Reset node excluding NMT master With this Value the NMT Slave will be set into the requested NMT State Reset Node, but the NMT Master will stay in its current NMT State.
87	Reserved	NMT service Reset communication excluding NMT master With this Value the NMT Slave will be set into the requested NMT State Reset communication, but the NMT Master will stay in its current NMT State.
88 to 8E	Reserved	
8F	Reserved	NMT service Enter Pre-operational excluding NMT master With this Value the NMT Slave will be set into the requested NMT State Pre-operational, but the NMT Master will stay in its current NMT State.
90 to FF	Reserved	

1	Introduction
2	Specifications
3	Installation
4	Wiring
5	Introduction of Functions
6	Allocation of Buffer Memories
7	Interface and Device Profile (405 mode)
8	Lift Application Profile (417 Mode)
9	CAN Layer 2 Mode
10	Command Interface

5.8.10 Request node guarding

This object indicates the node guarding state for a unique CANopen® device in the network. The sub-index corresponds to the node-ID of the CANopen® devices in the network. The sub-index H80 represents all nodes.

Note

If Node Guarding is not set, then Node Guarding will not start.

Object H1F83 Sub-index H01 to H80: Request node guarding

Value (hex)	Description	
	Read	Write
00	Node guarding stopped	Stop node guarding
01	Node guarding started	Start node guarding
02 to FF	Reserved	

5.8.11 Flying Master

The Flying Master mechanism provides services for a hot stand-by NMT Master within a CANopen® network. All Flying Masters shall monitor the Heartbeat of all masters in the network. A new negotiation is automatically started if the active master fails. The master with the highest priority and the lowest node-ID wins the negotiation. A new negotiation is started when a new NMT master with a higher priority than the active NMT Master join the network. The Flying NMT master priority is defined by (NMT master priority level × 128 + Node-Id), the lower value has the higher priority.

BFM #25 bit 15 indicates if the module is the current NMT Master.

Note

- If the module has enabled the Flying Master function and no Heartbeat producing is set, the Heartbeat producing is automatically set to 1000 ms.
- If the module loses the negotiation and no Heartbeat consuming is set for the active NMT master, Heartbeat consuming is automatically set to (1500 + 10 × Node-ID) ms.
- If the Heartbeat producing and consuming is set manually, set a different value for the consuming time of one Node-ID on the other Flying masters so that multiple masters will not initiate at the same time a new Flying master negotiation when the active NMT master times out.
- If a Flying Master is in the Network which is not a FX3U-CAN, ensure that this node has Heartbeat producing enabled, otherwise the FX3U-CAN with activated Flying Master function will send endless Reset Communication NMT Messages!

→ For the Communication Status (BFM #25), refer to Section 6.8

- All Flying Masters should have the same configuration for the Slaves.
- Configure in the Flying master negotiation response wait time of all Flying Master.

Formula for the Flying Master negotiation response wait time:

Flying Master negotiation response wait time =

$$(NMT\ master\ priority) \times (Priority\ time\ slot) + (Node-ID) \times (Node\ time\ slot)$$

- During the Flying master negotiation process, an NMT service Reset communication message will be sent to all nodes.

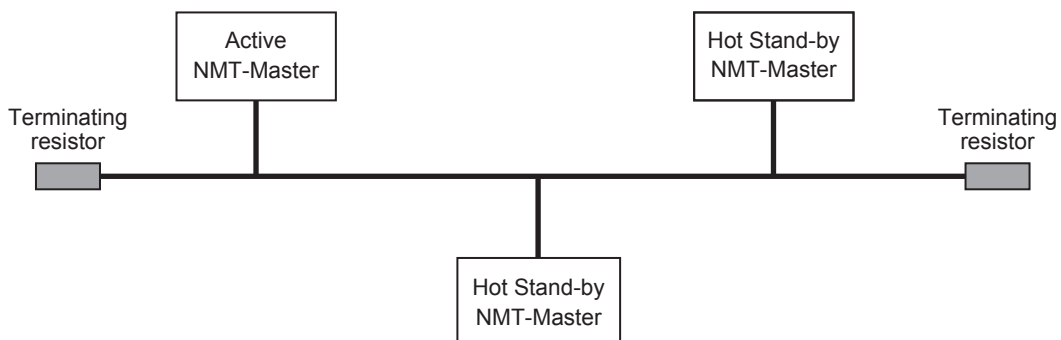

Point

When using the Flying Master function, please consider the following points:

- The Network communication will be reset after the Active NMT Master fails which will result in an Interruption of the System Application.
- Application data will be not synchronized by the Flying Master mechanisms. This has to be handled by a proper CANopen® configuration and CANopen® system planning.
- Be careful with the setting of the NMT flying master timing parameters. An inappropriate setting will result in a Malfunction of the Flying Master negotiation. Test the System Configuration before field use.

Figure 5.5: NMT flying master process

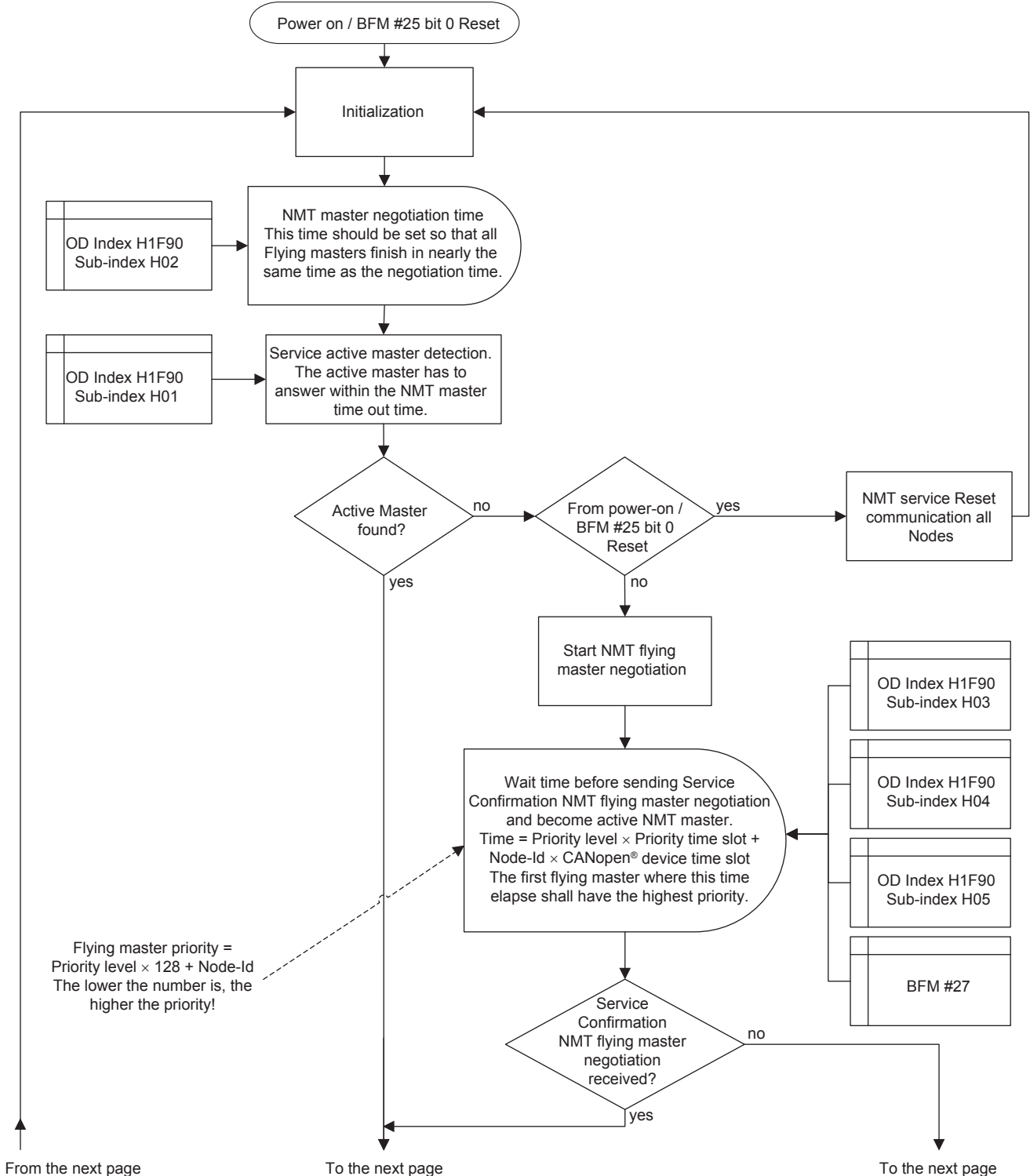

1	Introduction
2	Specifications
3	Installation
4	Wiring
5	Introduction of Functions
6	Allocation of Buffer Memories
7	Interface and Device Profile (405 mode)
8	Lift Application Profile (417 Mode)
9	CAN Layer 2 Mode
10	Command Interface

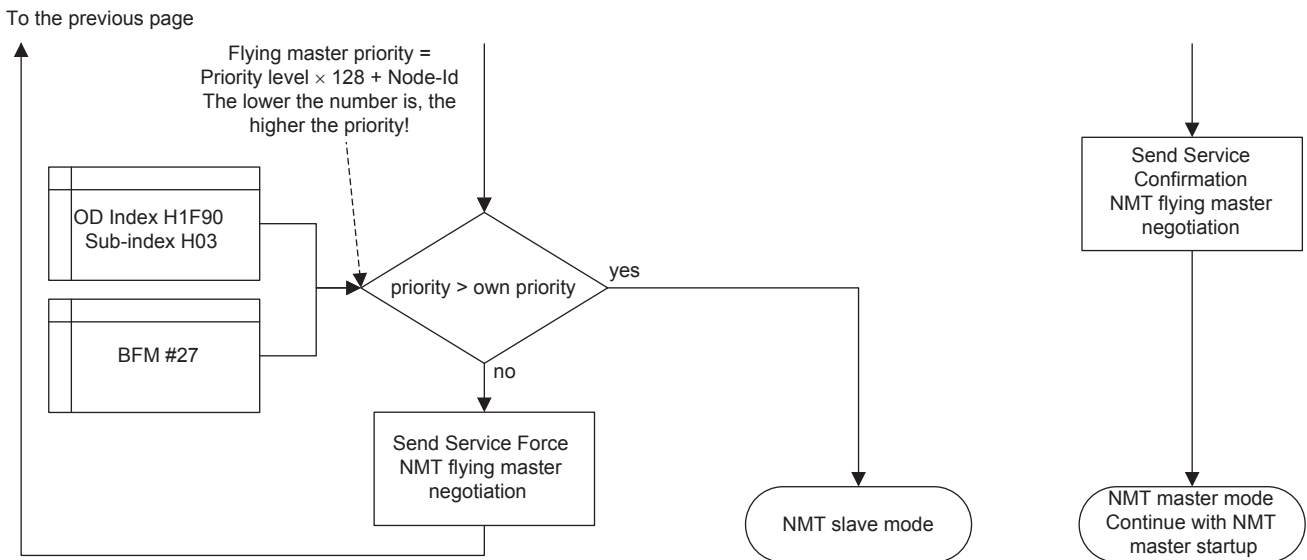

1. Object H1F80: NMT startup

Set H1F80 bit 5 to ON to participate in NMT flying master negotiation.

→ For NMT startup, refer to Subsection 5.8.5

2. Object H1F90: NMT flying master timing parameter

This object defines the parameters for the NMT flying master negotiation process.

3. Object H1F90 Sub-index H01: NMT master timeout

The value is in units of ms.

4. Object H1F90 Sub-index H02: NMT master negotiation time delay

The value is in units of ms.

5. Object H1F90 Sub-index H03: NMT master priority



Value (hex)	Description
0000	Priority high
0001	Priority medium
0002	Priority low
0003 to FFFF	Reserved

6. Object H1F90 Sub-index H04: Priority time slot

The value is in units of ms.

Formula for the Priority time slot:

Priority time slot > 127 × {CANopen[®] device time slot (Sub-index H05)}

7. Object H1F90 Sub-index H05: CANopen[®] device time slot

The value is in units of ms.

8. Object H1F90 Sub-index H06 Multiple NMT master detect cycle time

The value is in units of ms.

5.8.12 LSS

The FX3U-CAN uses the layer setting services and protocols, to configure via the CAN network the Baud Rate and the Node Address of an LSS slave device that is sealed against harsh environments and that does not have any hardware components like DIP-switches for setting the node-ID or bit timing parameters.

Within a CANopen[®] network, only one LSS-Master is allowed to exist. For the LSS-Master Mode the module has to be the active NMT-Master.

To activate the LSS Master, configure in the Object dictionary:

- Index H1F89:
The Boot time out. The time shall be longer than the boot time of the NMT-Client, which needs the longest time for boot-up (Power On until Boot-up message).
- Indexes H1F84 to H1F88, the Sub-index which corresponds to the Node-Id which shall be set at the LSS-Client:
The Identification information which is available at the Object dictionary Indexes H1000 and H1018 at the LSS-Client.
- Index H1F81, the Sub-index which corresponds to the Node-Id which shall be set at the LSS-Client:
Set bit 0 NMT Slave, bit 2 NMT boot slave and bit 3 Mandatory device.

If the LSS Slave is not found on the configured baud rate, the FX3U-CAN changes automatically the baud rate to find the LSS Slave. Through communication with a different baud rate, it can come to a Bus off condition at the other devices in the network. If the device does not support automatically recovering from Bus off or needs too much time for recovering, it's not possible to configure the LSS-Client.

It is recommended to establish a Point to Point connection for the configuration and to delete the Serial number entry (Index H1F88) after configuration to prevent an unwanted start of the LSS Master.

→ For Boot time, refer to Object Dictionary Index H1F89 in Section 5.6

→ For NMT slave identification, refer to Object Dictionary Index H1F84 to H1F88 in Subsection 5.8.4

→ For configuration, refer to Object Dictionary Index H1F81 in Subsection 5.8.7

Note

Check if the LSS-Client has activated an internal Bus termination. If necessary, deactivate the Bus termination first to prevent unwanted behaviour of the connected nodes on the bus.

5.8.13 Configuration manager

The Configuration manager provides mechanisms for configuration of CANopen[®] devices in a CANopen[®] network. For saving and requesting the CANopen[®] device Configuration, the following Objects are used. The sub-indexes are according to node-ID. The Configuration manager can be only used on the active NMT Master.

Note

If during the Configuration upload to the NMT slave a failure other than SDO access failure at read only Indexes and Sub indexes occurs, the configuration will be stopped.

1

Introduction

2

Specifications

3

Installation

4

Wiring

5

Introduction of Functions

6

Allocation of Buffer Memories

7

Interface and Device Profile (405 mode)

8

Lift Application Profile (417 Mode)

9

CAN Layer 2 Mode

10

Command Interface

1. Object H1020: Verify configuration

This object indicates the downloaded configuration date and time on the NMT Slave. A configuration manager uses this object to verify the configuration after a reset to check if a reconfiguration is necessary. If on a NMT Slave the Object dictionary configuration is changed, the Sub-indexes H01 and H02 values will be set to H0. At the time of NMT Slave boot-up, the Configuration manager compares the corresponding entries of H1020 on the Slave with its own setting in the Indexes H1F26 and H1F27 (see below) and decides if a reconfiguration is necessary or not. This mechanism reduces the time of NMT Slave bootup.

Sub-index H01: Configuration date; contains the number of days since 1984-01-01.

Sub-index H02: Configuration time; contains the number of ms after midnight.

2. Object H1F22 Sub-index H01 to H7F: Concise DCF

These objects save a configuration file with the Concise DCF format into the node-ID corresponding sub-index. A CANopen[®] configuration software and a CAN-Bus PC-Interface is necessary for the generation of a CANopen[®] configuration and saving over the CAN Bus.

Up to 60 Concise DCFs can be stored on the FX3U-CAN. The maximum size for each entry is 65531 byte.

Note

- To delete a Sub-index entry write "0" to this Sub-index. Erasing an entry requires 2 to 10 seconds. During this time, it is not possible to write a new file.
If the Flash ROM is busy, an SDO write access error H06060000 will occur.
- When the FX3U-CAN responds to an SDO write access to a Sub-index with SDO Error H06010002, this Sub-index already had been used. Delete the Sub-index entry by using the aforesaid method.
- When the FX3U-CAN responds to an SDO write access to a Sub-index with SDO access Error H06070010, the CDCF File is bigger than 65531 bytes, or this Sub-index has already been used. Check the File size and delete the Sub-index entry by using the aforesaid method.
- If the used CANopen[®] configuration Software has a problem with the automatic transfer of the Concise DCF be cause of Flash ROM busy errors, please use the selective download of the files if supported.
- All H1F22 Sub-indexes can also be deleted by the Restore default parameter command.
- Self-configuration over the Sub-Index of the entry corresponding to own Node-Id is not supported.
- The Concise DCF data will be directly stored on the Flash ROM. A Store parameters command over Object Dictionary Index H1010 is not necessary (Refer to Section 4.6.11).

→ For Store parameters, refer to Subsection 5.6.11

→ For Restore default parameters, refer to Subsection 5.6.12

3. Object H1F25 Sub-index H01 to H80: Configuration request

To initiate a configuration request for a CANopen[®] node, use the SDO write command in the CIF and write H666E6F63 (ISO8859 String code: "conf") to the corresponding sub-index of the FX3U-CAN. The sub-index H80 initiates a configuration request for all CANopen[®] devices in the network for which CDCF data are stored. A configuration request to the self node-ID will be ignored and no error response will be generated.

For Sub-index H01 to H7F, a SDO failure H08000024 will occur if no data are stored for this Node-Id.

A configuration request to the Sub-index of the entry corresponding to own Node-Id will be ignored.

→ For SDO write command in the CIF, refer to Subsection 10.2.3

4. Object H1F26 Sub-index H01 to H7F: Expected configuration date

This object is used by CANopen[®] configuration software for verification of the configuration date of the CANopen[®] devices in the network. The value contains the number of days since 1984-01-01.

5. Object H1F27 Sub-index H01 to H7F: Expected configuration time

This object is used by CANopen[®] configuration software for verification of the configuration time of the CANopen[®] devices in the network. The value contains the number of ms after midnight.

5.9 Device Profile CiA[®] 405 V2.0 for IEC 61131-3 Programmable Devices

This section describes the Device Profile for IEC 61131-3 programmable devices. The objects for data read/write support signed 8bit, unsigned 8bit, signed 16bit, unsigned 16bit, signed 32bit, unsigned 32bit and float 32bit. The corresponding Objects in the Object dictionary can be directly accessed via the BFM from the PLC. → Refer to Section 7.1

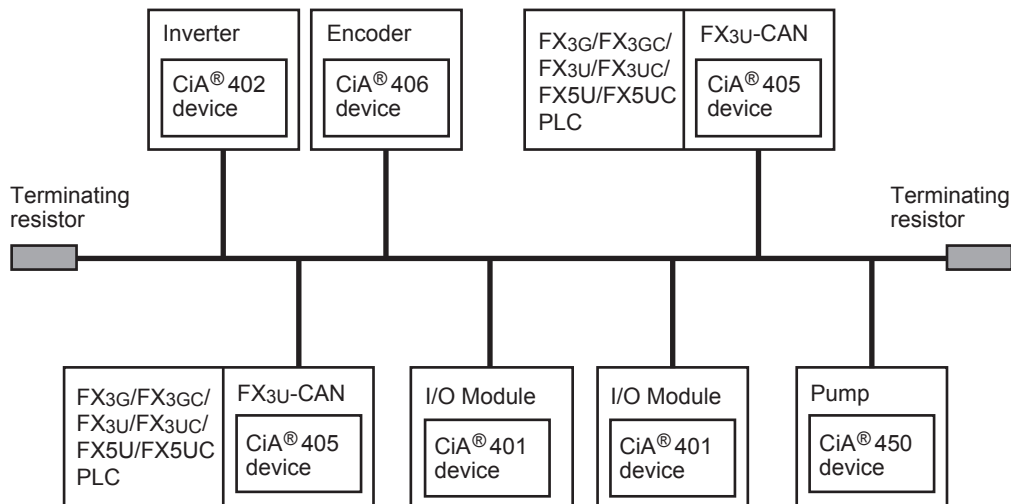

The table below provides a brief description and reference information for the FX3U-CAN CANopen[®] Object Dictionary.

Index (hex)	Sub-index (hex)	Object	Description	Data type	Initial value	Read/Write
A000	00	Input network variables	Highest sub-index	U8	HF0	R
	01 to F0		Signed Integer 8 bit	I8	K0	R
A001	00	Input network variables	Highest sub-index	U8	HF0	R
	01 to F0		Signed Integer 8 bit	I8	K0	R
A002	00	Input network variables	Highest sub-index	U8	HA0	R
	01 to A0		Signed Integer 8 bit	I8	K0	R
A040	00	Input network variables	Highest sub-index	U8	HF0	R
	01 to F0		Unsigned Integer 8 bit	U8	K0	R
A041	00	Input network variables	Highest sub-index	U8	HF0	R
	01 to F0		Unsigned Integer 8 bit	U8	K0	R
A042	00	Input network variables	Highest sub-index	U8	HA0	R
	01 to A0		Unsigned Integer 8 bit	U8	K0	R
A0C0	00	Input network variables	Highest sub-index	U8	H78	R
	01 to 78		Signed Integer 16 bit	I16	K0	R
A0C1	00	Input network variables	Highest sub-index	U8	H78	R
	01 to 78		Signed Integer 16 bit	I16	K0	R
A0C2	00	Input network variables	Highest sub-index	U8	H50	R
	01 to 50		Signed Integer 16 bit	I16	K0	R
A100	00	Input network variables	Highest sub-index	U8	H78	R
	01 to 78		Unsigned Integer 16 bit	U16	K0	R
A101	00	Input network variables	Highest sub-index	U8	H78	R
	01 to 78		Unsigned Integer 16 bit	U16	K0	R
A102	00	Input network variables	Highest sub-index	U8	H50	R
	01 to 50		Unsigned Integer 16 bit	U16	K0	R
A1C0	00	Input network variables	Highest sub-index	U8	HA0	R
	01 to A0		Signed Integer 32 bit	I32	K0	R

Index (hex)	Sub-index (hex)	Object	Description	Data type	Initial value	Read/Write
A200	00	Input network variables	Highest sub-index	U8	HA0	R
	01 to A0		Unsigned Integer 32 bit	U32	K0	R
A240	00	Input network variables	Highest sub-index	U8	HA0	R
	01 to A0		Float 32 bit	Real32	K0	R
A480	00	Output network variables	Highest sub-index	U8	HF0	R
	01 to F0		Signed Integer 8 bit	I8	K0	R/W
A481	00	Output network variables	Highest sub-index	U8	HF0	R
	01 to F0		Signed Integer 8 bit	I8	K0	R/W
A482	00	Output network variables	Highest sub-index	U8	HA0	R
	01 to A0		Signed Integer 8 bit	I8	K0	R/W
A4C0	00	Output network variables	Highest sub-index	U8	HF0	R
	01 to F0		Unsigned Integer 8 bit	U8	K0	R/W
A4C1	00	Output network variables	Highest sub-index	U8	HF0	R
	01 to F0		Unsigned Integer 8 bit	U8	K0	R/W
A4C2	00	Output network variables	Highest sub-index	U8	HA0	R
	01 to A0		Unsigned Integer 8 bit	U8	K0	R/W
A540	00	Output network variables	Highest sub-index	U8	H78	R
	01 to 78		Signed Integer 16 bit	I16	K0	R/W
A541	00	Output network variables	Highest sub-index	U8	H78	R
	01 to 78		Signed Integer 16 bit	I16	K0	R/W
A542	00	Output network variables	Highest sub-index	U8	H50	R
	01 to 50		Signed Integer 16 bit	I16	K0	R/W
A580	00	Output network variables	Highest sub-index	U8	H78	R
	01 to 78		Unsigned Integer 16 bit	U16	K0	R/W
A581	00	Output network variables	Highest sub-index	U8	H78	R
	01 to 78		Unsigned Integer 16 bit	U16	K0	R/W
A582	00	Output network variables	Highest sub-index	U8	H50	R
	01 to 50		Unsigned Integer 16 bit	U16	K0	R/W
A640	00	Output network variables	Highest sub-index	U8	HA0	R
	01 to A0		Signed Integer 32 bit	I32	K0	R/W
A680	00	Output network variables	Highest sub-index	U8	HA0	R
	01 to A0		Unsigned Integer 32 bit	U32	K0	R/W
A6C0	00	Output network variables	Highest sub-index	U8	HA0	R
	01 to A0		Float 32 bit	Real32	K0	R/W

5.10 Application Profile CiA[®] 417 V2.1 for Lift Control Systems

This application profile describes the virtual devices (hereinafter called VD) of lift control systems. The virtual controllers (e.g. call, car door, and car drive controller) perform dedicated control functions of the lift application. The virtual units (e.g. input and output panels, car door, light barrier, car position, car drive, load-measuring) are implemented each in single CANopen[®] devices or combined in one or more CANopen[®] devices. The FX3U-CAN implements the VD call controller, car drive controller and the car door controller.

The VD Call controller receives all call requests from these VD input panels, and transmits the corresponding acknowledgements to the VD output panels. The VD car door controller transmits commands to the VD car door unit and the VD light barrier unit. The VD car driver controller transmits commands to the VD car drive unit. It receives status information from the VD car drive unit and the VD load-measuring unit. If the profile position mode is used, additional status information from the VD car position unit is needed. It is recommended to give the Call controller the lowest node-ID.

The lift control system application profile shares the Object Dictionary area from H6000 to H9FFF. The area from H6000 to H60FF is related to the CANopen[®] device and not to one of the lift-control applications. The area from H6100 to H62FF is related to the VD input panel units, they do not belong to a specific lift control. The Indexes H6010 and H6011 are related to the VD Call controller and do not belong to a specific lift control. It is possible to realize up to 8 lift-control applications. For the specific lift control application 1, the area H6200 to H67FE is used. For other lift control applications, the area H6200 to H67FE is shifted as follows:

- H6200 to H67FE lift control application 1
- H6A00 to H6FFE lift control application 2
- H7200 to H77FE lift control application 3
- H7A00 to H7FFE lift control application 4
- H8200 to H87FE lift control application 5
- H8A00 to H8FFE lift control application 6
- H9200 to H97FE lift control application 7
- H9A00 to H9FFE lift control application 8

CiA[®] 417 Application

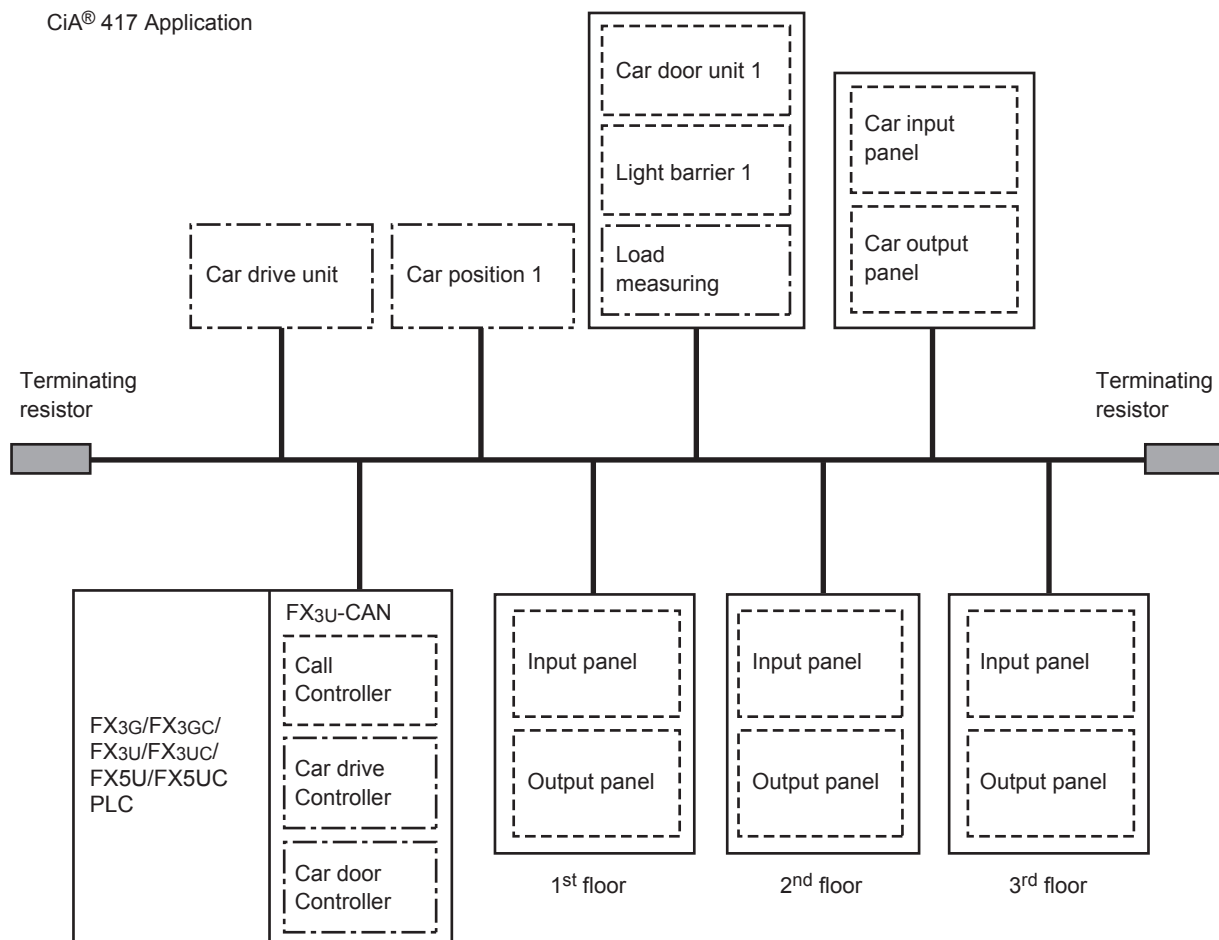

The table below provides a brief description and reference information for the FX3U-CAN CANopen® Object Dictionary.

Note: Stored to Flash ROM

Data will be saved to the Flash ROM by using the Store Parameter command in Index H1010. Be careful with write handling. The maximum number of writes to the built-in flash ROM is 10,000 times.

Index (hex)	Sub-index (hex)	Object	Description	Data type	Initial value	Read/Write	Stored to Flash ROM	
1 to 8: 6000	00	Supported virtual device types	Number of supported VD	U8	H03	R	-	
	01		Call controller	U16	H100	R	-	
	02		Car door controller	U16	H400	R	-	
	03		Car drive controller	U16	H800	R	-	
1 to 8: 6001	00	Lift number	→ Refer to Subsection 5.10.1	U8	H1	R/W	✓	
1 to 8: 6008	00	Specification version	-	U16	H2021	R	-	
1 to 8: 6010	00	Virtual input mapping	→ Refer to Subsection 5.10.2 Note: • SDO read access does not return the actual data of the input buffer. • SDO write access does not write to the input buffer.	U48	H0	R/W	-	
1 to 8: 6011	00	Virtual output mapping	→ Refer to Subsection 5.10.3	U48	H0	R	-	
1: 6300 2: 6B00 3: 7300 4: 7B00 5: 8300 6: 8B00 7: 9300 8: 9B00	00	Door control word	Highest sub-index	U8	H04	R	-	
	01		→ Refer to Subsection 5.10.4	Door 1	U16	H0	R	-
	02			Door 2	U16	H0	R	-
	03			Door 3	U16	H0	R	-
	04			Door 4	U16	H0	R	-
1: 6301 2: 6B01 3: 7301 4: 7B01 5: 8301 6: 8B01 7: 9301 8: 9B01	00	Door status word	Highest sub-index	U8	H04	R	-	
	01		→ Refer to Subsection 5.10.5	Door 1	U16	HFFFF	R/W	-
	02			Door 2	U16	HFFFF	R/W	-
	03			Door 3	U16	HFFFF	R/W	-
	04			Door 4	U16	HFFFF	R/W	-
1: 6302 2: 6B02 3: 7302 4: 7B02 5: 8302 6: 8B02 7: 9302 8: 9B02	00	Door position	Highest sub-index	U8	H04	R	-	
	01		The value is in units of mm. H0: Closed HFFFF: Not available or not requested	Door 1	U16	HFFFF	R/W	-
	02			Door 2	U16	HFFFF	R/W	-
	03			Door 3	U16	HFFFF	R/W	-
	04			Door 4	U16	HFFFF	R/W	-
1: 6310 2: 6B10 3: 7310 4: 7B10 5: 8310 6: 8B10 7: 9310 8: 9B10	00	Light barrier status	Highest sub-index	U8	H04	R	-	
	01		→ Refer to Subsection 5.10.6	Door 1	U8	HFF	R/W	-
	02			Door 2	U8	HFF	R/W	-
	03			Door 3	U8	HFF	R/W	-
	04			Door 4	U8	HFF	R/W	-

Index (hex)	Sub-index (hex)	Object	Description	Data type	Initial value	Read/Write	Stored to Flash ROM	
1: 6383 2: 6B83 3: 7383 4: 7B83 5: 8383 6: 8B83 7: 9383 8: 9B83	00 01 02 03 04	Position value	Highest sub-index	U8	H04	R	-	
			The position value from the car position units. The values shall be equivalent to Object H6004 of the CiA [®] 406 specifications.	Position unit 1	U32	HFFFF FFFF	R/W	-
				Position unit 2	U32	HFFFF FFFF	R/W	-
				Position unit 3	U32	HFFFF FFFF	R/W	-
				Position unit 4	U32	HFFFF FFFF	R/W	-
1: 6390 2: 6B90 3: 7390 4: 7B90 5: 8390 6: 8B90 7: 9390 8: 9B90	00 01 02 03 04	Speed value car	Highest sub-index	U8	H04	R	-	
			The speed value from the car position units. The measuring step is defined in multiples of 0.1 mm/s in the object H6384 of the car position unit.	Position unit 1	I16	H0	R/W	-
				Position unit 2	I16	H0	R/W	-
				Position unit 3	I16	H0	R/W	-
				Position unit 4	I16	H0	R/W	-
1: 6391 2: 6B91 3: 7391 4: 7B91 5: 8391 6: 8B91 7: 9391 8: 9B91	00 01 02 03 04	Acceleration value car	Highest sub-index	U8	H04	R	-	
			The acceleration value from the car position units. The measuring step is defined in multiples of 1 mm/s ² in the object H6384 of the car position unit.	Position unit 1	I16	H0	R/W	-
				Position unit 2	I16	H0	R/W	-
				Position unit 3	I16	H0	R/W	-
				Position unit 4	I16	H0	R/W	-
1: 6400 2: 6C00 3: 7400 4: 7C00 5: 8400 6: 8C00 7: 9400 8: 9C00	00	Control word	→ Refer to Subsection 5.10.7	U16	H0	R	-	
1: 6401 2: 6C01 3: 7401 4: 7C01 5: 8401 6: 8C01 7: 9401 8: 9C01	00	Status word	→ Refer to Subsection 5.10.8	U16	H0	R/W	-	
1: 6403 2: 6C03 3: 7403 4: 7C03 5: 8403 6: 8C03 7: 9403 8: 9C03	00	Modes of operation	→ Refer to Subsection 5.10.9	I8	H0	R	-	
1: 6404 2: 6C04 3: 7404 4: 7C04 5: 8404 6: 8C04 7: 9404 8: 9C04	00	Modes of operation display	→ Refer to Subsection 5.10.10	I8	H0	R/W	-	
1: 6406 2: 6C06 3: 7406 4: 7C06 5: 8406 6: 8C06 7: 9406 8: 9C06	00	Control effort	This object shall contain the breaking point or breaking distance depending on the target position given respectively as absolute value or relative value. The value shall be given in user-defined position units.	I32	H0	R/W	-	

1

Introduction

2

Specifications

3

Installation

4

Wiring

5

Introduction of Functions

6

Allocation of Buffer Memories

7

Interface and Device Profile (405 mode)

8

Lift Application Profile (417 Mode)

9

CAN Layer 2 Mode

10

Command Interface

Index (hex)	Sub-index (hex)	Object	Description	Data type	Initial value	Read/Write	Stored to Flash ROM	
1: 6407 2: 6C07 3: 7407 4: 7C07 5: 8407 6: 8C07 7: 9407 8: 9C07	00	Position actual value	This object is equivalent to object H6064 in the CiA [®] 402-2 V3.0 specifications, and shall contain the position of the drive shaft. This information is used to calculate the slippage of the position unit. The value shall be given in user-defined position units.	U32	HFFFF FFFF	R/W	-	
1: 6420 2: 6C20 3: 7420 4: 7C20 5: 8420 6: 8C20 7: 9420 8: 9C20	00	Target position	→ Refer to Subsection 5.10.11	I32	H0	R	-	
1: 6423 2: 6C23 3: 7423 4: 7C23 5: 8423 6: 8C23 7: 9423 8: 9C23	00	Profile velocity	This object is equivalent to object H6081 in the CiA [®] 402-2 V3.0 specifications. The value is in units of mm/s.	U32	H0	R	-	
1: 6430 2: 6C30 3: 7430 4: 7C30 5: 8430 6: 8C30 7: 9430 8: 9C30	00	Target velocity	This object is equivalent to object H60FF in the CiA [®] 402-2 V3.0 specifications. The value is in units of mm/s.	I32	H0	R	-	
1: 6433 2: 6C33 3: 7433 4: 7C33 5: 8433 6: 8C33 7: 9433 8: 9C33	00	Velocity actual value	This object is equivalent to object H606C in the CiA [®] 402-2 V3.0 specification. The value is in units of mm/s.	I32	H0	R/W	-	
1: 6480 2: 6C80 3: 7480 4: 7C80 5: 8480 6: 8C80 7: 9480 8: 9C80	00	Load value	Highest sub-index	U8	H02	R	-	
	01		→ Refer to Subsection 5.10.12	Absolute load value	U16	HFFFF	R/W	-
	02		SI unit	U16	H2	R/W	-	
1: 6482 2: 6C82 3: 7482 4: 7C82 5: 8482 6: 8C82 7: 9482 8: 9C82	00	Load signalling	Highest sub-index	U8	H02	R	-	
	01		→ Refer to Subsection 5.10.13	Load signal	U8	H0	R/W	-
	02		Load signal interrupt	U8	H0	R/W	-	

5.10.1 Lift number

This Object contains the lift number to which the FX3U-CAN is assigned. The Bit for the assigned lift number is set to ON (1).

7	6	5	4	3	2	1	0
Lift 8	Lift 7	Lift 6	Lift 5	Lift 4	Lift 3	Lift 2	Lift 1

5.10.2 Virtual input mapping

This Object contains the last received input data from one of the digital input panel group objects.

47 ... 40	39 ... 32	31 ... 24	23 ... 16	15 ... 8	7 ... 0
Function data	Door	Floor	Lift	Sub-function	Basic function

1. Basic function field

Bit 0 to 7 Value (hex)	Description
00	Reserved
01	Generic input
02	Standard hall call request
03	Low priority hall call request
04	High priority hall call request
05	Standard car call request
06	Low priority car call request
07	High priority car call request
08	Standard destination call
09	Low priority destination call
0A	High priority destination call
0B	Standard call to destination floor
0C	Low priority call to destination floor

Bit 0 to 7 Value (hex)	Description
0D	High priority call to destination floor
0E	Special function
0F	Access code upload request
10	Speech connection request
11	Area monitoring connection request
12	Fire detector
13 to 15	Reserved
16	Status of safety-related circuitries (This is not safety-related information.)
17 to 1F	Reserved
20	Guest call
21 to 7F	Reserved
80 to FF	Manufacturer-specific

2. Sub-function field

The Sub-function field is interpreted differently depending on the basic function field value.

Basic function field Bit 0 to 7 value (hex)	Sub-function field Bit 8 to 15 value (hex)	Description
01	00	Reserved
	01	Generic input 1
	⋮	⋮
	FE	Generic input 254
	FF	Reserved
02 to 04	00	Reserved
	01	Hall call up
	02	Hall call down
	03	Hall call
	04	Hall call extra up
	05	Hall call extra down
	06	Hall call extra
07 to FF	Reserved	
05 to 0D	00	Reserved
	01 to FE	Floor number 1 to 254
	FF	Reserved
0E	00	Reserved
	01	Request fan 1
	02	Request fan 2
	03	Request load time 1
	04	Request load time 2
	05	Key lock 1
	06	Key lock 2
	07	Key lock 3
	08	Key lock 4
	09	Request door open
	0A	Request door close
	0B	Fire recall (key switch hall panel)
	0C	Fire service (key switch car panel)
	0D	Hall call disable
	0E	Attendant service
0F	VIP service	
10	Out of order	
11	Bed passenger service	

Basic function field Bit 0 to 7 value (hex)	Sub-function field Bit 8 to 15 value (hex)	Description
0E	12	Special service
	13	Service run
	14	Dogging service enable
	15	Dogging service up
	16	Dogging service down
	17	Fire alarm (external fire alarm system)
	18	Provide priority
	19	Lift attendant start button
	1A	Lift attendant drive through button
	1B	Security run
	1C	Second call panel
	1D	Door enable
	1E	Call cancel button fire operation
	1F	Fire alarm reset
	20	Body detector (e.g. person in car)
21	Earthquake detector	
22 to FF	Reserved	
0F to 11	00 to FF	Reserved
	00	Reserved
	01 to FE	Fire detector 1 to 254
12	FF	Reserved
	00 to FF	Reserved
13 to 15	00	Reserved
	01 to 03	Safety-related circuitry 1 to 3
	04	Hall/swing door
	05	Car door
	06	Door lock
16	07 to FF	Reserved
	00 to FF	Reserved
	00	Reserved
17 to 1F	00 to FF	Reserved
	00	Reserved
	01 to FE	Guest call 1 to 254
20	FF	Reserved
	00 to FF	Reserved
21 to 7F	00 to FF	Reserved
	00 to FF	Manufacturer-specific

3. Lift field

The Bit for the requested lift number is set to ON (1).

23	22	21	20	19	18	17	16
Lift 8	Lift 7	Lift 6	Lift 5	Lift 4	Lift 3	Lift 2	Lift 1

4. Floor field

Bit 24 to 31 Value (hex)	Description
00	Car panel
01 to FE	Panel of floor 1 to 254
FF	Reserved

5. Door field

This value provides the door number to which the sending virtual device is assigned. The structure of the field depends on the value of the basic function field.

- When the basic function field is H08 to H0D, the structure of the door field is shown below:

39	38	37	36	35	34	33	32
Destination door 4	Destination door 3	Destination door 2	Destination door 1	Source door 4	Source door 3	Source door 2	Source door 1

- When the basic function field is H00 to H07 or H0E to HFF, the structure of the door field is shown below:

39 ... 36	35	34	33	32
H0	Door 4	Door 3	Door 2	Door 1

6. Function data field

The function data provides the input state of a virtual input.

47	46 ... 42	41 ... 40
lock	Reserved	Input state

Bit No.	Item	Description															
Bit 40 and 41	Input state	<table border="1"> <thead> <tr> <th>Bit 41</th> <th>Bit 40</th> <th>Description</th> </tr> </thead> <tbody> <tr> <td>OFF (0)</td> <td>OFF (0)</td> <td>Input state is OFF.</td> </tr> <tr> <td>OFF (0)</td> <td>ON (1)</td> <td>Input state is ON.</td> </tr> <tr> <td>ON (1)</td> <td>OFF (0)</td> <td>Function is defective</td> </tr> <tr> <td>ON (1)</td> <td>ON (1)</td> <td>Function is not installed</td> </tr> </tbody> </table>	Bit 41	Bit 40	Description	OFF (0)	OFF (0)	Input state is OFF.	OFF (0)	ON (1)	Input state is ON.	ON (1)	OFF (0)	Function is defective	ON (1)	ON (1)	Function is not installed
		Bit 41	Bit 40	Description													
		OFF (0)	OFF (0)	Input state is OFF.													
		OFF (0)	ON (1)	Input state is ON.													
		ON (1)	OFF (0)	Function is defective													
ON (1)	ON (1)	Function is not installed															
Bit 42 to 46	Reserved																
Bit 47	lock	OFF (0): Button or key-button has no locking function ON (1): Button or key-button has locking function															

5.10.3 Virtual output mapping

This Object contains the output data for one of the digital output group objects.

47 ... 40	39 ... 32	31 ... 24	23 ... 16	15 ... 8	7 ... 0
Function data	Door	Floor	Lift	Sub-function	Basic function

1. Basic function field

Bit 0 to 7 Value (hex)	Description	Bit 0 to 7 Value (hex)	Description
00	Call controller commands	11	Area monitoring connection acknowledgement
01	Generic output	12 to 1F	Reserved
02	Standard hall call acknowledgement	20	Guest call acknowledgement
03	Low priority hall call acknowledgement	21 to 3F	Reserved
04	High priority hall call acknowledgement	40	Position indication
05	Standard car call acknowledgement	41	Hall lantern
06	Low priority car call acknowledgement	42	Direction indication
07	High priority car call acknowledgement	43	Special indication
08	Standard destination call acknowledgement	44	Arrival indication
09	Low priority destination call acknowledgement	45	Operation data
0A	High priority destination call acknowledgement	46	Publicity indication
0B	Standard call to destination floor acknowledgement	47	Speech synthesis
0C	Low priority call to destination floor acknowledgement	48 to 49	Reserved
0D	High priority call to destination floor acknowledgement	4A	Miscellaneous outputs
0E	Special function acknowledgement	4B to 7F	Reserved
0F	Access code upload acknowledgement	80 to FF	Manufacturer-specific
10	Speech connection acknowledgement		

2. Sub-function field

The Sub-function field is interpreted differently depending on the basic function field value.

Basic function field Bit 0 to 7 value (hex)	Sub-function field Bit 8 to 15 value (hex)	Description
00	00	Reserved
	01	Request all active hall calls
	02	Request all special inputs (basic functions 0E and 12)
	03 to FF	Reserved
01	00 to FF	Reserved
02 to 04	00	Reserved
	01	Hall call up acknowledgement
	02	Hall call down acknowledgement
	03	Hall call acknowledgement
	04	Hall call extra up acknowledgement
	05	Hall call extra down acknowledgement
	06	Hall call extra acknowledgement
	07 to FF	Reserved
05 to 0D	00	Reserved
	01 to FE	Target stop acknowledgement 1 to 254
	FF	All target stop buttons
0E	00	Reserved
	01	Request fan 1 acknowledgement
	02	Request fan 2 acknowledgement
	03	Request load time 1 acknowledgement
	04	Request load time 2 acknowledgement
	05	Request key lock 1 acknowledgement
	06	Request key lock 2 acknowledgement
	07	Request key lock 3 acknowledgement

Basic function field Bit 0 to 7 value (hex)	Sub-function field Bit 8 to 15 value (hex)	Description											
0E	08	Request key lock 4 acknowledgement											
	09	Request door open acknowledgement											
	0A	Request door close acknowledgement											
	0B	Fire recall (key switch hall panel) acknowledgement											
	0C	Fire service (key switch hall panel) acknowledgement											
	0D	Hall call disable acknowledgement											
	0E	Attendant service acknowledgement											
	0F	VIP service acknowledgement											
	10	Out of order acknowledgement											
	11	Bed passenger service acknowledgement											
	12	Special service acknowledgement											
	13	Service run acknowledgement											
	14	Dogging service enable acknowledgement											
	15	Dogging service up acknowledgement											
	16	Dogging service down acknowledgement											
	17	Fire alarm (external fire alarm system) acknowledgement											
	18	Provide priority acknowledgement											
	19	Lift attendant start button acknowledgement											
	1A	Lift attendant drive through button acknowledgement											
	1B	Security run acknowledgement											
	1C	Second call panel acknowledgement											
	1D	Door enable acknowledgement											
1E	Call cancel button fire operation												
1F	Fire alarm reset acknowledgement												
20	20	Body detector (e.g. person in car)											
	21	Earthquake detector											
22 to FF	22 to FF	Reserved											
	00 to FF	Reserved											
20	00	Reserved											
	01 to FE	Guest call acknowledgement 1 to 254											
21 to 3F	FF	Reserved											
	00 to FF	Reserved											
40	00	Clear the floor data											
	01 to FE	Floor number 1 to 254											
	FF	Reserved											
41	This sub-function shows the arrow display direction up/down.												
	<table border="1" style="margin-left: 20px;"> <tr> <td style="text-align: center;">15 ... 10</td> <td style="text-align: center;">9</td> <td style="text-align: center;">8</td> </tr> <tr> <td style="text-align: center;">H0</td> <td style="text-align: center;">Down</td> <td style="text-align: center;">Up</td> </tr> </table>	15 ... 10	9	8	H0	Down	Up	OFF (0): Do not display the arrow ON (1): Display the arrow					
15 ... 10	9	8											
H0	Down	Up											
42	This sub-function shows the arrow display direction up/down, and the transfer direction display of car.												
	<table border="1" style="margin-left: 20px;"> <tr> <td style="text-align: center;">15 ... 14</td> <td style="text-align: center;">13</td> <td style="text-align: center;">12</td> <td style="text-align: center;">11 ... 10</td> <td style="text-align: center;">9</td> <td style="text-align: center;">8</td> </tr> <tr> <td style="text-align: center;">H0</td> <td style="text-align: center;">Moving down</td> <td style="text-align: center;">Moving up</td> <td style="text-align: center;">H0</td> <td style="text-align: center;">Down</td> <td style="text-align: center;">Up</td> </tr> </table>	15 ... 14	13	12	11 ... 10	9	8	H0	Moving down	Moving up	H0	Down	Up
15 ... 14	13	12	11 ... 10	9	8								
H0	Moving down	Moving up	H0	Down	Up								
43	00	Used for instruction → all displays off											
	01	No load											
	02	Full load											
	03	Over load											
	04	Fire											

Basic function field Bit 0 to 7 value (hex)	Sub-function field Bit 8 to 15 value (hex)	Description						
43	05	Fire brigade service						
	06	Help is coming						
	07	Special service						
	08	Load time						
	09	Occupied						
	0A	Out of order						
	0B	Close door						
	0C	Case of fire						
	0D	Hall call disable						
	0E	Travel to evacuation floor						
	0F	Travel to fire recall floor						
	10 to FF	Reserved						
44	This sub-function shows the arrival indication up/down. <div style="display: flex; align-items: center; margin-top: 10px;"> <div style="margin-right: 20px;"> <table border="1" style="border-collapse: collapse;"> <tr> <td style="padding: 2px 10px;">15 ... 10</td> <td style="padding: 2px 10px;">9</td> <td style="padding: 2px 10px;">8</td> </tr> <tr> <td style="padding: 2px 10px; text-align: center;">H0</td> <td style="padding: 2px 10px; text-align: center;">Down</td> <td style="padding: 2px 10px; text-align: center;">Up</td> </tr> </table> </div> <div> OFF (0): Not arrived ON (1): Arrived </div> </div>		15 ... 10	9	8	H0	Down	Up
15 ... 10	9	8						
H0	Down	Up						
45 to 46	00 to FF	Reserved						
47	00	Switch off speech synthesis on all output panels						
	01 to FE	Announce floor number 1 to 254						
	FF	Announce current floor number						
48 to 49	00 to FF	Reserved						
4A	00	Reserved						
	01	Hall call enable						
	02	Lift operational						
	03 to FF	Reserved						
4B to 7F	00 to FF	Reserved						
80 to FF	00 to FF	Manufacturer-specific						

3. Lift field

This value provides the lift number or the group of lifts, to which the output is assigned.

23	22	21	20	19	18	17	16
Lift 8	Lift 7	Lift 6	Lift 5	Lift 4	Lift 3	Lift 2	Lift 1

4. Floor field

Bit 24 to 31 Value (hex)	Description
00	Car panel
01 to FE	Floor number 1 to 254
FF	All floor panels

5. Door field

This value provides the door number to which the output is assigned. The structure of the field depends on the value of the basic function field. If the bits of the door field are set to 1, this shall indicate an assignment of the output to this door.

- When the basic function field is H08 to H0D, the structure of the door field is shown below:

39	38	37	36	35	34	33	32
Destination door 4	Destination door 3	Destination door 2	Destination door 1	Source door 4	Source door 3	Source door 2	Source door 1

- When the basic function field is H00 to H07 or H0E to HFF, the structure of the door field is shown below:

39 ... 36	35	34	33	32
H0	Door 4	Door 3	Door 2	Door 1

6. Function data field

The function data provides the input state of a virtual input.

47	46 ... 44	43 ... 41	40
Predicate	Property parameter	Property	Status

Bit No.	Item	Description
Bit 40	Status	OFF (0): No data indicated (Does not apply for basic function H40) ON (1): Data indicated
Bit 41 to 43	Property	Bit 41 to 43 value (hex) H0: No action (default) H1: Output continuously H2: Output pulsed H3: Output flashing H4: Output coloured H5: Output with volume H6: Output with scroll rate H7: Reserved
Bit 44 to 46	Property parameter	Refer to table below
Bit 47	Predicate	OFF (0): Acknowledgement is not affirmed ON (1): Acknowledgement is affirmed

Value definition of the property parameter field (Bit 44 to 46)

Bit 44 to 46 value (hex)	Description						
	No action	Continuous	Pulsed	Flashing	Colour	Volume	Scroll rate
0	No action	Reserved	< 0.5 s	10 Hz	White	Minimum	Automatic
1			1 s	7.5 Hz	Yellow	Vary	1 line/s
2			1.5 s	5 Hz	Reserved	Vary	2 line/s
3			2 s	2 Hz	Green	Vary	3 line/s
4			3 s	1.5 Hz	Reserved	Vary	4 line/s
5			5 s	1 Hz	Red	Vary	5 line/s
6			10 s	0.5 Hz	Reserved	Vary	6 line/s
7			> 15 s	0.25 Hz	Blue	Maximum	7 line/s

5.10.4 Door control word

This Object contains the door commands and other control data.

15 ... 12	11 ... 10	9 ... 8	7 ... 6	5 ... 4	3 ... 2	1 ... 0
Command	Door velocity	Motion detector	Finger protector	Door lock	Battery power	H3

1. Battery power field

Bit 2 to 3 Value (hex)	Description
0	Battery power supply disabled
1	Battery power supply enabled
2	Reserved
3	Do not care / take no action

2. Door lock field

Bit 4 to 5 Value (hex)	Description
0	Enable door lock
1	Disable door lock
2	Reserved
3	Do not care / take no action

3. Finger protector field

Bit 6 to 7 Value (hex)	Description
0	Enable finger protector
1	Disable finger protector
2	Reserved
3	Do not care / take no action

4. Motion detector field

Bit 8 to 9 Value (hex)	Description
0	Enable motion detector
1	Disable motion detector
2	Reserved
3	Do not care / take no action

5. Door velocity field

Bit 10 to 11 Value (hex)	Description
0	Move door with standard speed
1	Move door with reduced speed
2	Reserved
3	Do not care / take no action

6. Command field

Bit 12 to 15 Value (hex)	Description
0	Close door without limit force (Not allowed for EN-81 compliant lifts)
1	Close door with limit force
2	Nudging (Forced closing of car door with reduced speed without reversal devices due to the door being blocked for too long)
3	Open door without limit force (Not allowed for EN-81 compliant lifts)
4	Open door with limit force
5	Reserved
6	Reserved
7	Stop door without torque
8	Stop door with torque
9 to C	Reserved
D	Tech-in drive
E	Reset door
F	Do not care / take no action

5.10.5 Door status word

This Object contains the car door status and other status information.

15 ... 12	11 ... 10	9 ... 8	7 ... 6	5 ... 4	3 ... 2	1 ... 0
Status	Force limit	Motion detector	Finger protector	Door lock	Battery power	Safety contact

1. Safety contact field

Bit 0 to 1 Value (hex)	Description
0	Contact not closed
1	Contact closed
2	Error indicator
3	Not available or not installed

1

Introduction

2

Specifications

3

Installation

4

Wiring

5

Introduction of Functions

6

Allocation of Buffer Memories

7

Interface and Device Profile (405 mode)

8

Lift Application Profile (417 Mode)

9

CAN Layer 2 Mode

10

Command Interface

2. Battery power field

Bit 2 to 3 Value (hex)	Description
0	No battery power used
1	Battery power used
2	Error indicator
3	Not available or not installed

3. Door lock field

Bit 4 to 5 Value (hex)	Description
0	Door not locked
1	Door locked
2	Error indicator
3	Not available or not installed

4. Finger protector field

Bit 6 to 7 Value (hex)	Description
0	No finger detected
1	Finger detected
2	Error indicator
3	Not available or not installed

5. Motion detector field

Bit 8 to 9 Value (hex)	Description
0	Motion not detected
1	Motion detected
2	Error indicator
3	Not available or not installed

6. Force limit field

Bit 10 to 11 Value (hex)	Description
0	Force limit not reached
1	Force limit reached
2	Error indicator
3	Not available or not installed

7. Status field

Bit 12 to 15 Value (hex)	Description
0	Door closed with torque
1	Door closed without torque
2	Door is closing
3	Door opened with torque
4	Door opened without torque
5	Door is opening
6	Door is re-opening
7	Door stopped with torque (not in an end position)
8	Door stopped without torque (not in an end position)
9 to C	Reserved
D	Tech-in drive
E	Error indicator
F	Not available or not installed

Note

If the door is in an open or closed end position, this shall have higher priority than stopped status.

5.10.6 Light barrier status

This Object contains the status information of the VD light barrier unit for up to four doors.

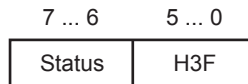

Bit 6 to 7 Value (hex)	Description
0	No subject detected
1	Subject detected
2	Error indicator
3	Not available or not installed

5.10.7 Control word

This object is based on object H6040 of the CiA® 402-2 V3.0 specifications.

Note

- Bits 9, 6, 5, and 4 of the control word are operation mode specific.
- The halt function (bit 8) behaviour is operation mode specific.
If the bit is ON (1), the commanded motion shall be interrupted; the Power drive system shall behave as defined in the halt option code.
After releasing the halt function, the commanded motion shall be continued if possible.

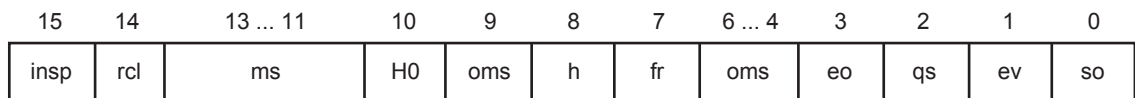

Bit	Item	Description
Bit 0	so	Switch on
Bit 1	ev	Enable voltage
Bit 2	qs	Quick stop
Bit 3	eo	Enable operation
Bit 4 to 6	oms	Operation mode specific (Show in the Users Manual of the remote device)
Bit 7	fr	Fault reset
Bit 8	h	Halt
Bit 9	oms	Operation mode specific (Show in the Users Manual of the remote device)
Bit 10	-	Bit 10 fixed to OFF (0).
Bit 11 to 13	ms	Manufacturer-specific (Show in the Users Manual of the remote device)
1Bit 4	rcl	OFF (0): Emergency recall operation mode inactive ON (1): Emergency recall operation mode active
Bit 15	insp	OFF (0): Car top inspection operation mode inactive ON (1): Car top inspection mode active

Status transition

Number: Transition No.

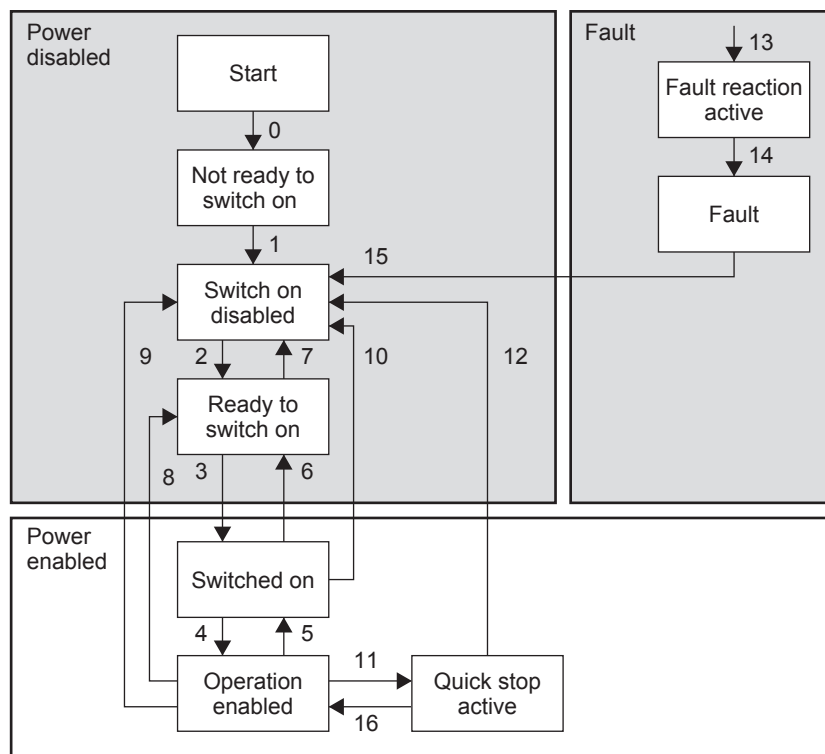

Command	Bits of the control word					Transition No.
	Bit 7	Bit 3	Bit 2	Bit 1	Bit 0	
Shutdown	0	X	1	1	0	2, 6, 8
Switch on	0	0	1	1	1	3
Switch on + enable operation	0	1	1	1	1	3 + 4 (Note)
Disable voltage	0	X	X	0	X	7, 9, 10, 12
Quick stop	0	X	0	1	X	7, 10, 11
Disable operation	0	0	1	1	1	5
Enable operation	0	1	1	1	1	4, 16
Fault reset	0 → 1	X	X	X	X	15

Note

- At the following Transition numbers occur a automatic status transition: 0, 1, 13, 14
- Automatic transition to enable operation state after executing SWITCHED ON state functionality.

5.10.8 Status word

This object is equivalent to object H6041 in the CiA[®] 402-2 V3.0 specification.

15 ... 14	13 ... 12	11	10	9	8	7	6	5	4	3	2	1	0
ms	oms	ila	tr	rm	ms	w	sod	qs	ve	f	oe	so	rtso

Bit No.	Item	Description / set range
Bit 0	rtso	Ready to switch on
Bit 1	so	Switched on
Bit 2	oe	Operation enabled
Bit 3	f	Fault
Bit 4	ve	Voltage enabled ON when high voltage is applied to the Power drive system.
Bit 5	qs	Quick stop OFF When the Power drive system is reacting on a quick stop request.
Bit 6	sod	Switch on disabled
Bit 7	w	Warning ON when being a warning condition. The status of the Power drive system Finite state automaton does not be changed as warning is not an error or fault.
Bit 8	ms	Manufacturer-specific
Bit 9	rm	Remote When this bit is ON, the control word is processed. If it is off (local), the control word is not processed.
Bit 10	tr	Target reached <ul style="list-style-type: none"> ON when the Power drive system has reached the set-point. The set-point is operation mode specific. This Bit is set to on, if the operation mode has been changed. ON if the quick stop option code is 5, 6, 7 or 8, when the quick stop operation is finished and the Power drive system is halted. ON when halt occurred and the Power drive system is halted.
Bit 11	ila	Internal limit active ON when an internal limit is active.
Bit 12 to 13	oms	Operation mode specific (Show in the Users Manual of the remote device)
Bit 14 to 15	ms	Manufacturer-specific (Show in the Users Manual of the remote device)

Status Word	Power Drive System Finite State Automaton State
xxxx xxxx x0xx 0000 b	Not ready to switch on
xxxx xxxx x1xx 0000 b	Switch on disabled
xxxx xxxx x01x 0001 b	Ready to switch on
xxxx xxxx x01x 0011 b	Switched on
xxxx xxxx x01x 0111 b	Operation enabled
xxxx xxxx x00x 0111 b	Quick stop active
xxxx xxxx x0xx 1111 b	Fault reaction active
xxxx xxxx x0xx 1000 b	Fault

5.10.9 Modes of operation

This object is equivalent to object H6060 in the CiA[®] 402-2 V3.0 specifications.

Value	Description
-128 to -1	Manufacturer-specific operation modes
0	No mode change or no mode assigned
+1	Profile position mode
+2	Velocity mode
+3	Profile velocity mode
+4	Torque profile mode
+5	Reserved
+6	Homing mode
+7	Interpolated position mode
+8	Cyclic sync position mode
+9	Cyclic sync velocity mode
+10	Cyclic sync torque mode
+11 to +127	Reserved

5.10.10 Modes of operation display

This object is equivalent to object H6061 in the CiA[®] 402-2 V3.0 specifications. This object provides the actual operation mode.

The value description can be shown in the Modes of operation object.

→ Refer to Subsection 5.10.9

5.10.11 Target position

This object is equivalent to object H607A in the CiA[®] 402-2 V3.0 specifications. This object contains the commanded position that the drive should move to in position profile mode using the current settings of motion control parameters such as velocity, acceleration, deceleration, motion profile type etc. The value of this object shall be interpreted as absolute or relative depending on the 'abs/rel' flag in the control word. It shall be given in user-defined position units and shall be converted to position increments.

5.10.12 Load value

This object contains the load value (sub-index H01) and the related SI unit (sub-index H02). The load value is the absolute value of the load (payload). It is in units of the configured SI unit. The load value of HFFFF shall be an error value that is applied if the sensor is in error state or does not have an actual value.

SI unit structure

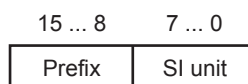

The default SI unit is kg. The SI unit and prefix field values shall use the coding defined in the CiA[®] 303-2 specifications.

5.10.13 Load signalling

This object contains load signal information. It is used to signal measuring values of the load measuring system. Sub-index H01 contains different kinds of load signals. If one of the load bits (for zero load, norm load, full load, and overload) is set to ON (1), the related condition is true. If the bit is set to 0, the related condition is not true. Sub-index H02 contains the information regarding whether the related load bit shall be processed (1) or not (0).

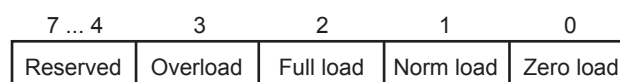

6. Allocation of Buffer Memories

6.1 Buffer Memories (BFM) Lists

Caution

- Do not access buffer memory (BFM) that is marked as "Reserved" (Ex. BFM #23, #28, #31 to #34, #40 to #49, #60 to #99, #400, #443 to #600, etc.) by FROM/TO instructions, etc. There is a possibility to cause abnormal behavior to the operation of the FX3U-CAN if accessing these buffer memories.
- When BFM #21, #24, #26, #27, #59, #70, #71, #100 to #399, #1100 to #1267, #1900 to #1927 are written to, FX3U-CAN stores the state of the corresponding BFM in the built-in flash ROM. The maximum number of writes to the built-in flash ROM is 10,000 times.
While BFM #25 bit7 is ON, any TO access is prohibited and will generate a BFM #29 bit5 failure!

Note

- When writing to a BFM that contains any bits marked as "Reserved" (Ex. BFM #20 bit 1 to bit 15, BFM #22 bit 2 to bit 15, etc), set such bits to OFF.
There is a possibility to cause abnormal behavior to the operation of the FX3U-CAN if setting these flags to ON.
- Use BFM #22 to store the configuration.

BFM No.	Description	Default value	Read/Write	Stored to Flash ROM	Reference
BFM #0 to #19	Receive/Transmit Process Data (CANopen® modes only)	H0	R/W	-	*1
BFM #20	Data Exchange Control	H0	R/W	-	Section 6.4
BFM #21	Function mode	K405	R/W	✓	Section 6.5
BFM #22	Save/Restore Configuration	H0	R/W	-	Section 6.6
BFM #23	Reserved	-	-	-	-
BFM #24	Baud Rate	K250	R/W	✓	Section 6.7
BFM #25	Communication Status	K0	R/W	-	Section 6.8
BFM #26	FROM/TO Watchdog	K20	R/W	✓	Section 6.9
BFM #27	Node Address (CANopen® modes only)	K127	R/W	✓	Section 6.10
BFM #28	Reserved	-	-	-	-
BFM #29	Error Status	H0	R/W	-	Section 14.2
BFM #30	Module ID code	K7170	R	-	Section 6.12
BFM #31 to #34	Reserved	-	-	-	-
BFM #35	CAN transmission error counter	H0	R	-	Section 6.13
BFM #36	CAN reception error counter	H0	R	-	Section 6.14
BFM #37	Baud Rate display	K2500	R	-	Section 6.15
BFM #38	Sampling Point display	K875	R	-	Section 6.16
BFM #39	BFM setting error display	H0	R	-	Section 6.17
BFM #40	BFM initialisation/online mode write error display	H0	R	-	Section 6.18
BFM #41 to #49	Reserved	-	-	-	-

1 Introduction

2 Specifications

3 Installation

4 Wiring

5 Introduction of Functions

6 Allocation of Buffer Memories

7 Interface and Device Profile (405 mode)

8 Lift Application Profile (417 Mode)

9 CAN Layer 2 Mode

10 Command Interface

BFM No.	Description	Default value	Read/Write	Stored to Flash ROM	Reference
BFM #50	Time stamp producer/consumer (CANopen [®] modes only)	K1	R/W	-	Section 6.19
BFM #51	Time stamp year (CANopen [®] modes only)	K12	R/W	-	
BFM #52	Time stamp month (CANopen [®] modes only)	K3	R/W	-	
BFM #53	Time stamp day (CANopen [®] modes only)	K1	R/W	-	
BFM #54	Time stamp hour (CANopen [®] modes only)	K0	R/W	-	
BFM #55	Time stamp minute (CANopen [®] modes only)	K0	R/W	-	
BFM #56	Time stamp second (CANopen [®] modes only)	K0	R/W	-	
BFM #57	Time stamp Day-of-the-week (CANopen [®] modes only)	K4	R	-	
BFM #58	Time stamp transmission interval (CANopen [®] modes only)	K0	R/W	-	
BFM #59	Daily correction (CANopen [®] modes only)	K0	R/W	✓	
BFM #60 to #69	Reserved	-	-	-	-
BFM #70 ^{*3}	NMT Start all Nodes delay (CANopen [®] modes only)	K500	R/W	✓	Section 6.20
BFM #71 ^{*3}	SDO Time out (CANopen [®] modes only)	K500	R/W	✓	Section 6.21
BFM #72 to #99	Reserved	-	-	-	-
BFM #100 to #399	Receive/Transmit Process Data	H0	R/W	✓ ^{*2}	^{*1}
BFM #400	Reserved	-	-	-	-
BFM #401 to #442	Message Slot error code list (Layer 2 function modes only)	H0	R/W	-	Section 9.2
BFM #443 to #600	Reserved	-	-	-	-
BFM #601 to #726	NMT State (CANopen [®] modes only)	H0	R	-	Section 6.22
BFM #727		H7F	R	-	
BFM #728 to #749	Reserved	-	-	-	-
BFM #750 to #859	EMCY Message Buffer (CANopen [®] modes only)	H0	-	-	Section 6.23
BFM #860 to #899	Reserved	-	-	-	-
BFM #900 to #963	NMT Error Control Status (CANopen [®] modes only)	H0	R/W	-	Section 6.24
BFM #964 to #999	Reserved	-	-	-	-
BFM #1000 to #1066	Command Interface	H0	R/W	-	Chapter 10
BFM #1067 to #1099	Reserved	-	-	-	-
BFM #1100 to #1267	Pre-defined Layer 2 message configuration (Layer 2 modes only)	H0	R/W	✓ ^{*2}	Section 9.3
BFM #1268 to #1269	Reserved	-	-	-	-
BFM #1270 to #1272	Layer 2 RTR flags (Layer 2 modes only)	H0	R	-	Section 9.4
BFM #1273 to #1279	Reserved	-	-	-	-
BFM #1280 to #1282	Message transmit trigger flags (Layer 2 modes only)	H0	R/W	-	Section 9.5
BFM #1283 to #1899	Reserved	-	-	-	-
BFM #1900 to #1927	PLC RUN>STOP messages (Layer 2 modes only)	H0	R/W	✓ ^{*2}	Section 9.6
BFM #1956 to #2999	Reserved	-	-	-	-
BFM #3000 to #3539	Lift Application (CANopen [®] 417 Mode only)	-	-	-	Chapter 8

BFM No.	Description	Default value	Read/Write	Stored to Flash ROM	Reference
BFM #3540 to #9999	Reserved	-	-	-	-
BFM #10000 to #10319*3	Receive Process Data (RPDO) (CANopen® 405 Mode only)	H0	R	-	Section 7.1
BFM #10320 to #10999	Reserved	-	-	-	-
BFM #11000 to #11319*3	Transmit Process Data (TPDO) (CANopen® 405 Mode only)	H0	R/W	-	Section 7.1
BFM #11320 to #11999	Reserved	-	-	-	-
BFM #12000 to #12539*3	Lift Application Receive Data (RPDO) (CANopen® 417 Mode only)	-	R	-	Chapter 8
BFM #12540 to #12999	Reserved	-	-	-	-
BFM #13000 to #13539*3	Lift Application Transmit Data (TPDO) (CANopen® 417 Mode only)	-	R/W	-	Chapter 8
From #13540	Reserved	-	-	-	-

- *1. Refer to the following items for each function mode.
- When using CANopen® 405 mode, refer to Chapter 7
 - When using CANopen® 417 mode, refer to Chapter 8
 - When using the 11 bit CAN-ID Layer 2 mode or 29 bit CAN-ID Layer 2 mode, refer to Chapter 9
- *2. Only in Layer 2 mode. The configuration area of the BFM is stored into the Flash ROM.
For further information, refer to the following section.
→ Refer to Section 9.1
- *3. Applicable for FX3U-CAN firmware Ver.1.10 or later.

6.2 How to Read/Write from/to Buffer Memory

To read/write from/to buffer memory in the FX3U-CAN, use the FROM/TO instructions or the applied instructions that directly specify the buffer memory.

FX3U/FX3UC/FX5U/FX5UC PLC applicable software is required to perform direct specification of the buffer memory and bit specification of word devices.

For further information on applied instructions, bit specification of word devices, direct specification of buffer memory or special extension unit/block unit number, refer to following manual.

→ Refer to Programming manual

6.2.1 Direct specification of buffer memory (FX3U/FX3UC/FX5U/FX5UC only)

When directly specifying the buffer memory, specify the following device in the source or destination area of the applied instruction as follows:

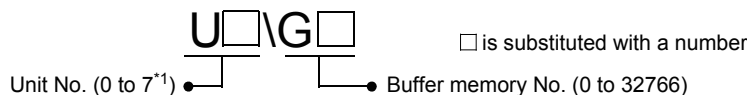

*1. Unit No. 2 to No. 16 is assigned when the CPU module is an FX5U/FX5UC.

1. Reading out BFM data to PLC (MOV instruction)

If the following program is created, 1 point of data will be read out from buffer memory BFM #30 of unit No.1 to data register D10.

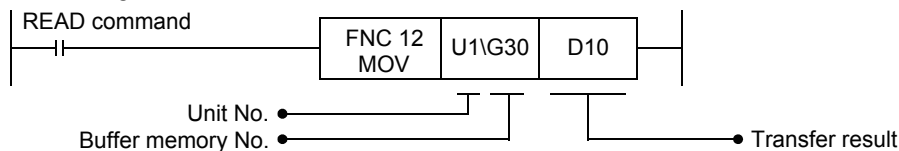

2. Writing PLC data into BFM (MOV instruction)

If the following program is created, 1 point of data (H0001) will be written to buffer memory BFM #21 of unit No.1.

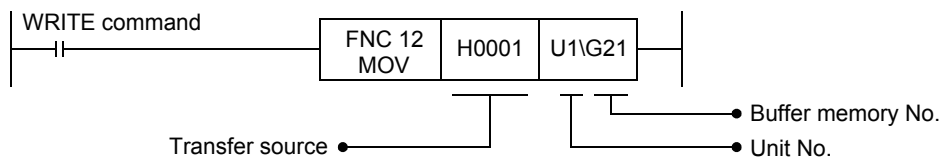

6.2.2 FROM/TO instructions

1. FROM instruction (Reading out BFM data to PLC)

Use the FROM instruction to read the data from the buffer memory.

If the following program is created, 1 point of data will be read out from buffer memory BFM #30 of unit No.1 to data register D10.

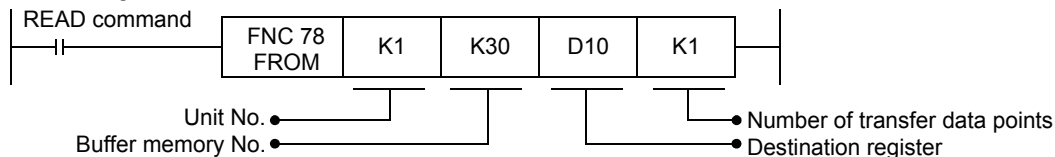

2. TO instruction (Writing PLC data into BFM)

Use the TO instruction to write data to buffer memory.

If the following program is created, 1 point of data (H0001) will be written to buffer memory BFM #21 of unit No.1.

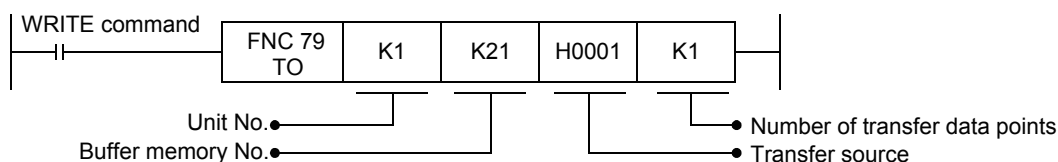

6.3 Receive/Transmit Process Data

BFM #10000 to #10319 and #11000 to #11319 locations in the FX3U-CAN module are used for data communication to the CAN bus. The mapping for where each data is sent/received is explained in the following chapter.

- When using CANopen[®] 405 mode, refer to Chapter 7
- When using CANopen[®] 417 mode, refer to Chapter 8
- When using the 11 bit CAN-ID Layer 2 mode or 29 bit CAN-ID Layer 2 mode, refer to Chapter 9

Note

In the CANopen[®] 417 Mode (BFM #21 = K417), only BFM #0 to #3, BFM #10000 to #10003 and BFM #11000 to #11003 (TPDO1/RPDO1) are usable. BFM #4 to #399, BFM #10004 to #10319 and BFM #11004 to #11319 are not accessible.

6.4 [BFM #20] Data Exchange Control

To ensure that the FX3U-CAN module can handle the CANopen[®] data in a consistent way, it is necessary to set in BFM #20 the corresponding Bit to ON before reading data (FROM) and after writing data (TO). The data exchange control signal ensures, by internal buffer exchange, that TO data from the PLC will be transmitted by PDO.

PDO transmit data will only be sent to the CAN bus if the module is in NMT state Operational and after setting the corresponding bits in BFM #20 to ON. As long as the reading of the previous data is not finished and a new exchange command to BFM #20 has not been sent, FROM data will not be overwritten by further PDO. If the module is in NMT state Operational, PDO data received from other nodes can be read by the FX3G/FX3GC/FX3U/FX3UC/FX5U/FX5UC PLC by using a FROM instruction, and transmit PDO data can be written to the module and sent to the network by using a TO instruction.

The exchange data bit's will be reset automatically when the data exchange between BFM and Object Dictionary/Data exchange buffer is finished.

Note

- BFM #20 bit 0 will be reset automatically.
- During an active data exchange (BFM #20 bit 0 is ON), new write access to this BFM will be ignored.

Bit	Description	
	FROM (Read Access)	TO (Write Access)
Bit 0	Data exchange status OFF: Data exchange between BFM's and Data Exchange Buffer completed ON: Module exchanges data between BFM's and Data exchange buffer Note: This bit has the same function as Bit 8	Data exchange mode Control OFF: No data exchange between BFM's and CANopen [®] object dictionary / Layer 2 message buffer ON: Activate data exchange between BFM's and CANopen [®] object dictionary / Layer 2 message buffer Notes: <ul style="list-style-type: none"> • This bit merges the function of Bit 8, 9 and 12. • If the bit is set and the Module is not in CANopen[®] state Pre-Operational or Stopped, the PDO data will be exchanged after going into Operational state.
Bit 1 to 7	Reserved	
Bit 8	Only in CANopen [®] modes: Data exchange status (only OD data) OFF: Data exchange between BFM's and Data Exchange Buffer completed ON: Module exchanges data between BFM's and Data exchange buffer Note: This bit has the same function as Bit 0	Only in CANopen [®] modes: Data exchange mode setting (only OD data) OFF: No data exchange between BFM and CANopen [®] object dictionary ON: Activate data exchange between BFM and CANopen [®] object dictionary Notes: <ul style="list-style-type: none"> • The RPDO data of the Virtual Input mapping BFM's are not included in this data exchange. It can be handled separately by Bit 9. • The data will be also exchanged by setting Bit 0 • If the bit is set and the Module is not in CANopen[®] state Operational, the PDO data will be exchanged after going into Operational state.

Bit	Description	
	FROM (Read Access)	TO (Write Access)
Bit 9	Reserved	<p>Only in 417 Function mode (Refer to BFM #21): Data exchange for the Virtual Input mapping BFM's. With this bit it's possible to read the Receive Buffer of the Virtual Input mapping without exchanging the data of all data exchange BFM's.</p> <p>OFF: No data exchange ON: Exchange data → For FROM access of BFM #3001 to 3003, refer to Section 8.3</p> <p>Note: The data will be also exchanged by setting Bit 0</p>
Bit 10 to 11	Reserved	
Bit 12	Reserved	<p>OFF: No data exchange between Emergency Message BFM's and EMCY Receive Buffer ON: Exchange data between Emergency Message BFM's and EMCY Receive Buffer → For Emergency Message Buffer, refer to Section 6.23</p> <p>Note: The data will be also exchanged by setting Bit 0</p>
Bit 13 to 15	Reserved	

6.5 [BFM #21] Function Mode

Function mode of FX3U-CAN is set up. FX3U-CAN chooses the communication function corresponding to the function mode set in BFM #21.

Note

- The BFM setting needs to be stored by BFM #22 bit 0 and afterwards be restarted by BFM #25 bit 0 to make the new settings effective.
→ Refer to Section 6.8
- For the CANopen[®] profile (CiA[®] 405 or CiA[®] 417) mode, all saved OD settings will be deleted after mode change restart.

Set Value	Function Mode	Description
K11	11 bit CAN-ID Layer 2 mode	This mode supports the 11 bit CAN-ID Layer 2 Message.
K29	29 bit CAN-ID Layer 2 mode	This mode supports the 29 bit CAN-ID Layer 2 Message.
K405 (default)	CANopen [®] 405 mode	This mode supports the CANopen CiA [®] 405 IEC 61131-3 Programmable Device Profile.
K417	CANopen [®] 417 mode	This mode supports the CANopen CiA [®] 417 Lift Application Profile.
Other value	All other settings will generate a BFM #29 bit 6 failure.	

6.6 [BFM #22] Save/Restore Configuration

This BFM supports two bits that allow the default configuration of the BFMs to be restored and the configuration from BFMs to be stored into Flash ROM. Both bits will be reset automatically if the restore or save procedure is completed.

Note

- If both flags are set simultaneously, the corresponding BFMs and Flash ROM will be reset to factory default settings.
- If only bit 1 is set, corresponding BFM areas are restored to factory default values but not stored in Flash ROM.
After changing the configuration, BFM #22 bit 0 has to be set ON to store these changed configuration BFMs to Flash ROM.

Object dictionary settings can be stored in Flash ROM and Object dictionary default settings can be restored using CIF commands.

→ For CIF command, refer to Section 10.6 and Section 10.7

Bit	Description	
	FROM (Read Access)	TO (Write Access)
Bit 0	ON when in store process.	Save configuration*1 to Flash ROM. When operation is completed, FX3U-CAN will automatically reset this bit.
Bit 1	ON when in restore process.	Restore factory default configuration (not saved to Flash ROM). When operation is completed, FX3U-CAN will automatically reset this bit.
Bit 2 to 15	Reserved	

*1. The stored/restored BFM configurations correspond to the function mode as shown in the table below;

Mode		Description	Reference
CANopen® 405 mode CANopen® 417 mode	11 bit CAN-ID Layer 2 mode 29 bit CAN-ID Layer 2 mode		
Saved	Saved	Function mode in BFM #21.	Section 6.5
Saved	Saved	Baud Rate in BFM #24.	Section 6.7
Saved	Saved	FROM/TO Watchdog in BFM #26.	Section 6.9
Saved	Not saved	Node Address in BFM #27.	Section 6.10
Saved	Not saved	Daily correction in BFM #59.	Section 6.19
Not saved	Saved	The CAN ID and data length for transmitting message in BFM #100 to #399.	Section 9.1
Not saved	Saved	Pre-defined Layer 2 message configuration in BFM #1100 to #1267.	Section 9.3
Not saved	Saved	PLC RUN>STOP message in BFM #1900 to #1927.	Section 9.6
Saved	Not saved	NMT start all Nodes delay in BFM #70	Section 6.20
Saved	Not saved	SDO Time Out in BFM #71	Section 6.21

6.7 [BFM #24] Baud Rate

Set the baud rate in this BFM. The current baud rate can be found in BFM #37.

Note

- The Baud Rate must be equal for all nodes in the network.
- The new value needs to be stored by BFM #22 and the Module has to be restarted to make the new setting effective.

BFM Value	Description
K10	Baud Rate 10kbps
K20	Baud Rate 20kbps
K50	Baud Rate 50kbps
K100	Baud Rate 100kbps
K125	Baud Rate 125kbps
K250	Baud Rate 250kbps
K500	Baud Rate 500kbps
K800	Baud Rate 800kbps
K1000	Baud Rate 1000kbps
Other value	Setting prohibited If an invalid baud rate is written to BFM #24, the BFM will keep its former value and BFM #29 bit 11 will be set.

6.8 [BFM #25] Communication Status

Displays the FX3U-CAN communication status.

Note

- A change of the function mode, the baud rate, or Node ID requires a restart of the FX3U-CAN to become effective.
- If a configuration BFM is written to while in online mode (BFM #25 bit 4 is ON), BFM #29 bit 5 will be set ON.
- When BFM #25 bit 7 is ON, the Module is initializing the internal data structures and the BFM, and any TO command (write access) prohibited. If the BFM is written to, BFM #29 bit 5 will be set to ON.
When BFM #25 bit 7 is bit ON, the only access allowed is to read (FROM) BFM #25 and BFM #29.

Module restart

When restarting the module, set BFM #25 Bit 0 to ON.

In this case, set data that was not saved will be lost.

Bit	Description	
	FROM (Read Access)	TO (Write Access)
Bit 0	Module online/offline Layer 2 modes: OFF: Offline ON: Online CANoper[®] modes: OFF: Not in Operational State ON: Operational State	Module restart A restart is necessary to activate a new setting of the function mode (BFM #21), the baud rate (BFM #24), the Node-ID (BFM #27) or to activate the NMT master setting. → Refer to Subsection 5.8.5 and Section 6.5, 6.7 and 6.10 All not saved settings will be lost. OFF: Normal operation ON: Restart module
Bit 1	OFF: The error counter is below the warning level, in error passive or in bus-off. ON: The error counter of the CAN controller has reached the warning level. → Refer to and Section 6.13 and 6.14	Reserved
Bit 2, 3	Reserved	

Bit	Description																
	FROM (Read Access)	TO (Write Access)															
Bit 4	<p>CANopen® mode: Reserved</p> <p>Layer 2 mode: OFF: Layer 2 request configuration mode ON: Layer 2 request online mode This bit must be set to ON to start data exchange with other network nodes. The configuration of the module can only be changed while this bit is OFF.</p> <p>Note: If a configuration BFM was changed during online mode, BFM #29 bit 5 is set to ON.</p>																
Bit 5	Reserved																
Bit 6	<p>OFF: No NMT Reset received. ON: The CANopen® Application was reset by an NMT Reset communication or NMT Reset Application command. All unsaved changes in the Object dictionary are lost and are set to factory default or to the former stored value. Write a 0 to reset the bit.</p> <p style="text-align: right;">→ Refer to Subsection 5.6.11</p> <p>The Bit is set to 0 in the beginning of the reset process.</p>																
Bit 7	<p>Module initialisation state</p> <p>In the case of a module restart request over BFM #25 bit 0 or over a CANopen® NMT command, this bit will set. This bit shall be monitored in the PLC program at all times to prohibit BFM #29 failures.</p> <p>OFF: Module initialisation finished ON: Module is in initialisation state</p>	Reserved															
Bit 9, 8	<p>CANopen® Network state</p> <table border="1"> <thead> <tr> <th>Bit 9</th> <th>Bit 8</th> <th>Description</th> </tr> </thead> <tbody> <tr> <td>OFF</td> <td>OFF</td> <td>Stopped State</td> </tr> <tr> <td>OFF</td> <td>ON</td> <td>Pre-operational State</td> </tr> <tr> <td>ON</td> <td>OFF</td> <td>Operational State</td> </tr> <tr> <td>ON</td> <td>ON</td> <td>Reserved</td> </tr> </tbody> </table>	Bit 9	Bit 8	Description	OFF	OFF	Stopped State	OFF	ON	Pre-operational State	ON	OFF	Operational State	ON	ON	Reserved	Reserved
Bit 9	Bit 8	Description															
OFF	OFF	Stopped State															
OFF	ON	Pre-operational State															
ON	OFF	Operational State															
ON	ON	Reserved															
Bit 10	<p>OFF: LSS Master routine inactive ON: LSS Master routine active This bit is only on when the LSS Master is searching and configuring LSS Slaves.</p>	Reserved															
Bit 11	<p>OFF: No failure ON: Mandatory NMT Slave startup failure, NMT Master startup stopped, Reset the NMT Master to restart the NMT Startup process</p> <p>Note: If all Mandatory Slaves are available and this failure occurs, the NMT Master configuration may be faulty. Check the NMT Master settings of the assigned Mandatory Slaves.</p>	Reserved															
Bit 12	<p>OFF: No Time Stamp object received ON: Time Stamp object received (Only if Consumer is set) Write a 0 to this bit to reset it.</p> <p style="text-align: right;">→ Refer to Subsection 5.6.10 and Section 6.19</p>																
Bit 13	<p>OFF: No failure ON: Optional NMT Slave startup failure, if the bit 14 is also 0 at the same time, the NMT Master startup stopped and the NMT Master needs to be Reset to restart the NMT Startup process</p> <p>Note: If all Optional Slaves are available and this failure occurs, the NMT Master configuration may be faulty. Check the NMT Master settings of the assigned Optional Slaves.</p>	Reserved															
Bit 14	<p>OFF: NMT Start-up Master: No Slave start-up in progress ON: NMT Start-up Master: Slave start-up in progress → Refer to Subsection 5.8.5</p> <p>Note: This bit goes on during the NMT master/slave startup and any time when a NMT slave error occurs and the NMT startup master tries to re-start the faulty NMT slave</p>	Reserved															
Bit 15	<p>OFF: Module works as NMT Slave ON: Module works as NMT Master</p>	Reserved															

1	Introduction
2	Specifications
3	Installation
4	Wiring
5	Introduction of Functions
6	Allocation of Buffer Memories
7	Interface and Device Profile (405 Mode)
8	Lift Application Profile (417 Mode)
9	CAN Layer 2 Mode
10	Command Interface

6.9 [BFM #26] FROM/TO Watchdog

The FROM/TO Watchdog can be used when the Module is online to monitor if the PLC program accesses data BFM #0 to BFM #19, BFM #100 to #399 or BFM #3000 to BFM #3539 cyclically.

After the first FROM/TO on the data BFM, the Watchdog will check if the next access to the data BFM takes place before the time set in BFM #26 expires.

BFM #26 sets the Watchdog timer in 10 ms steps (default value K20 equals 200 ms).

Note

- If the watchdog expires, bit 7 in BFM #29 is set to ON, and the messages defined in the BFM #1900 to #1927 "PLC RUN>STOP messages" area or an EMCY Object are transmitted on the network. If the module is in a CANopen[®] Mode, the module will react according to the value set in the Error behavior object (Index H1029) in the object dictionary.
 - For PLC RUN>STOP messages, refer to Section 9.6
 - For EMCY Object, refer to Subsection 5.6.13
 - For Error behaviour object, refer to Section 5.7
- If the watchdog function is not required, it can be deactivated by writing K0 to BFM #26.
- The FROM/TO watchdog can be restarted by writing the setting value to BFM #26 again, which will also reset the error flag in BFM #29.

6.10 [BFM #27] Node Address

This BFM sets CANopen[®] Node-ID. The setting value range is 1 to 127.

Note

- The BFM setting needs to be stored by BFM #22 bit 0 and afterwards be restarted by BFM #25 bit 0 to make the new setting effective.
- A setting out of the above range or a write access in Layer-2 function mode will generate a Failure Message in BFM #29 bit 6.

6.11 [BFM #29] Error Status

For further information on error status, refer to the following section.

→ Refer to Section 14.2

6.12 [BFM #30] Module ID Code

The identification code for FX3U-CAN is available using a FROM instruction. The identification code for the FX3U-CAN is K7170. By reading this identification code, the user may create built-in checking routines in the PLC program to check whether the physical position of the FX3U-CAN on the special function unit bus matches the program.

6.13 [BFM #35] CAN Transmission Error Counter

FX3U-CAN stores the current value of the CAN transmit error counter. The CAN transmit message error counter counts up to K256.

The counter counts 1 or 8 up if a transmission error is detected. For each transmission without error, the counter counts 1 down.

Value	Description
K0 to K127	Error active status Warning level if value is K96 to K127.
K128 to K255	Error passive status
K256	BUS-OFF status

Note

The Warning Level is also shown in BFM #25 bit 1, Error Passive and Bus OFF are shown in BFM #29.

6.14 [BFM #36] CAN Reception Error Counter

FX3U-CAN stores the current value of the CAN reception error counter. The CAN reception error counter counts up to K128.

The counter counts 1 or 8 up if a reception error is detected. For each reception without error, the counter counts 1 down.

However, when FX3U-CAN is in BUS-OFF status, K256 is stored in this BFM.

Value	Description
K0 to K127	Error active status Warning level if value is K96 to K127.
K128	Error passive status
K256	BUS-OFF status

Note

The Warning Level is also shown in BFM #25 bit 1, Error Passive and Bus OFF are shown in BFM #29.

6.15 [BFM #37] Baud Rate Display

Displays the current baud rate of the CAN Controller in units of 0.1 kbps.

6.16 [BFM #38] Sampling Point Display

Displays the current sampling point of the CAN Controller in units of 0.1%.

6.17 [BFM #39] BFM Setting Error Display

BFM #29 bit 6 is set to ON if an attempt to write an invalid value into a Buffer Memory is detected.

BFM #39 displays the address of the target BFM of the invalid write attempt. In case an irregular value was written to more than one BFM, only the address of the first BFM is displayed. BFM #39 is reset by writing K0 to BFM #29.

6.18 [BFM #40] BFM Initialisation/Online Mode Write Error Display

BFM #29 bit 5 is set to ON if an attempt to write into a Buffer Memory while module is in initialisation mode or in Layer 2 online mode is detected.

BFM #40 displays the target BFM address of the invalid write attempt. In case an irregular write access is made to more than one BFM, only the address of the first BFM is displayed. When BFM #29 bit 5 is set to OFF, BFM #40 will be reset to K0.

1

Introduction

2

Specifications

3

Installation

4

Wiring

5

Introduction of Functions

6

Allocation of Buffer Memories

7

Interface and Device Profile (405 mode)

8

Lift Application Profile (417 Mode)

9

CAN Layer 2 Mode

10

Command Interface

6.19 [BFM #50 to #59] Time Stamp

CANopen[®] devices which operate a local clock may use the TIME object to adjust their own time base to the time of the time stamp producer.

After power up or reset of the FX3U-CAN, the clock data is set to default values, and the clock is stopped. FX3U-CAN sets up producer or consumer of Time stamp by BFM #50. When FX3U-CAN is the current Network Master or Producer, set the clock data to BFM #51 to #59. The current Time stamp of CANopen[®] network can read the clock data from BFM #51 to #57.

- When the FX3U-CAN is set up as Consumer, the clock starts counting after receiving the first Time stamp object.
- When the FX3U-CAN is set up as Producer, the clock starts after setup of BFM #50 to #58.
- The FX3U-CAN will only produce the Time stamp if it is the current Network Master and in CANopen[®] state Operational or Pre-operational.

Note

- After power up or reset of the FX3U-CAN, the clock data is set to default values, and the clock is stopped.
- The data and time will be checked when BFM #56 is written. If value is outside of the allowed range BFM #29 bit 6 will be set to ON.
→ **For BFM #29 bit 6, refer to Section 14.2**
- When the FX3U-CAN is set up as consumer, write access to BFM #51 to #59 will be ignored.
- When FX3U-CAN is the current Network Master and Producer, the first time stamp will be sent after setting BFM #58.
- There is always a delay in time due to latency during writing to the BFM and during the transmission over the CAN bus.
- A leap year correction is provided.
- Clock tolerance: ±132 sec/month (at 25°C)
- The resolution of the Time stamp object in the FX3U-CAN is in units of second. All values outside of the Setting range will be ignored, and the old value will persist. If a Time stamp object is received, BFM #25 bit 12 will be set.
→ **For communication status (BFM #25), refer to Section 6.8**

Note: When handling built in clock data of PLC

The FX3U-CAN can handle built-in clock data of the PLC using TRD (FNC166) and TWR (FNC167) instructions. However, be careful of different year data specifications.

For further information on the TRD (FNC166) and TWR (FNC167) instructions and built-in clock data specifications of the PLC, refer to the following manual.

→ **Refer to Programming manual**

- CAN network
K0 to K99 in Time stamp year corresponds to year 2000 to 2099.
The higher two digits is ignored. If writing K1984, the module will send a Time stamp with the year 2084.
- FX Series PLC built-in RTC
K80 to K99 correspond to "1980 to 1999", and "00 to 79" correspond to "2000 to 2079".
Examples:
"80" indicates 1980. "99" indicates 1999. "00" indicates 2000. "79" indicates 2079.

BFM No.	Name	Description
BFM #50	Time stamp producer/consumer	<p>Sets the Time stamp producer/consumer. The BFM directly accesses the Consumer/Producer bits of the Time COB-ID in the Object Dictionary. → For Time object, refer to Subsection 5.6.10</p> <p>Setting range: K0: Time stamp disabled K1: Consumer K2: Producer*1 K3: Producer*1/Consumer</p>

*1. Time stamp will be only produced if the module is active NMT Master.

BFM No.	Name	Description
BFM #51	Time stamp year	K0 to K99 (lower two digits) K0 to K99 in Time stamp year corresponds to 2000 to 2099 year. The higher two digits is ignored. If writing K1984, the module will send a Time stamp with the year 2084.
BFM #52	Time stamp month	K1 (January) to K12 (December)
BFM #53	Time stamp day	K1 (1st) to K31 (31st)
BFM #54	Time stamp hour	K0 (0 o'clock) to K23 (23 o'clock)
BFM #55	Time stamp minute	K0 (00 minutes) to K59 (59 minutes)
BFM #56	Time stamp second	K0 (00 seconds) to K59 (59 seconds)
BFM #57	Time stamp Day-of-the-week	K0 (Sunday) to K6 (Saturday) This BFM is read only. The Day of the week will be calculated during setup of the RTC automatically.
BFM #58	Time stamp transmission interval	Set the transmission time interval for the Time stamp Object in multiples of minutes. The first time stamp will be sent after setting this BFM. If the FX3U-CAN is configured as Consumer, this setting will be ignored. Setting range; K0: Time stamp transmission disabled K1 to K1440: 1 minute to 1440 minutes (24 hours)
BFM #59	Daily correction	A constant miscount of the Clock can be corrected in steps of 1 sec / day. Setting range: -60 to +60

Time stamp setting procedure

To keep the consistency of Time stamp data, clock data should be set by the following procedure.

- 1) Set Time stamp producer/consumer in BFM #50.
- 2) Set clock data of Year, Month, Day, Hour and Minute in BFM #51 to #55. (Producer only)
- 3) Set clock data of Second in BFM #56.
All clock data will be written to the RTC and checked for validity when BFM #56 is written to. If the data is not valid, the RTC will not be set.
- 4) Set Time stamp transmission interval in BFM #58.
The first time stamp will be sent after BFM #58 is written to.

Time stamp read procedure

To keep the consistency of Time stamp data, clock data should be read by the following procedure.

- 1) Read clock data of Year from BFM #51.
All clock data will be read from the RTC and written to BFMs #51 to #57 when BFM #51 is read.
- 2) Read clock data of Month, Day, Hour, Minute, Second and Day-of-the-week from BFM #52 to #57.

6.20 [BFM #70] NMT Start all Nodes delay

During the NMT master startup, the NMT master sends a NMT Reset communication all Nodes and NMT Start all Nodes depending on the configuration.

This BFM value sets the minimum time between these two NMT messages, to ensure that a slow NMT Slave recognizes the NMT Start all Nodes message.

The value can be set in ms (default: 500ms).

The setting range is 0ms to 65535ms.

→ For NMT Startup process, refer to Subsection 5.8.4

6.21 [BFM #71] SDO Time out

The Time out for SDO communication set with this BFM.

The value can be set in ms (default: 500ms).

The setting range is 50ms to 32767ms.

→ For SDO, refer to Subsection 5.6.4

1

Introduction

2

Specifications

3

Installation

4

Wiring

5

Introduction of Functions

6

Allocation of Buffer Memories

7

Interface and Device Profile (405 mode)

8

Lift Application Profile (417 Mode)

9

CAN Layer 2 Mode

10

Command Interface

6.22 [BFM #601 to #727] NMT State

This BFM displays the NMT status of the CANopen[®] nodes (index H1F82, Sub index 01 to 127 of the CANopen[®] Object Dictionary). Use the SDO Command in the CIF to set the NMT state of the whole network or of one specific node. For NMT Slaves, the NMT Status is only displayed for Nodes for which Heartbeat Consuming is configured.

If the NMT Master is using Heartbeat Consuming or Node Guarding, the current NMT State of an NMT Slave will display its actual NMT State as long as error control messages are received. For Nodes for which no error control service is configured, the NMT Master will display the NMT state from the last request.

→ For Object H1F82, refer to Subsection 5.8.9

→ For Heartbeat, refer to Subsection 5.6.9

→ For SDO Command, refer to Section 10.2

Note

- If a NMT state request is made to all nodes, all BFM displays will change.
To activate the display of a missing mandatory device, configure the Boot time out (refer to Object Dictionary Index H1F89) and set this Node-Id as a mandatory CANopen[®] device (refer to Object Dictionary Index H1F81).
→ For Object Dictionary Index H1F89, refer to Section 5.6
→ For Object Dictionary Index H1F81, refer to Subsection 5.8.7
- If no error control service is configured or if error control messages are missing, it is possible that an NMT state other than the actual remote NMT state will be displayed. Use these BFMs and BFM #900 to #963 NMT Error Control Status and BFM #29 to detect error control service failures.
→ For BFM #900 to #963, refer to Section 6.24
→ For BFM #29, refer to Section 14.2

BFM No.	Description
BFM #601	Node 1
BFM #602	Node 2
BFM #603	Node 3
⋮	⋮
BFM #726	Node 126
BFM #727	Node 127

6.23 [BFM #750 to #859] Emergency Message Buffer

The FX3U-CAN will store the Emergency messages which are received from the bus to an internal buffer. This buffer can store up to 22 emergency messages and is separated into an 11 message stack buffer (BFM #750 to #804) and an 11 message ring buffer (BFM #805 to #859). The stack buffer will store the first 11 emergency messages received after Power On or after the Emergency message buffer was cleared the last time. The ring buffer will store the next eleven Emergency messages; all further received Emergency telegrams will overwrite the oldest message in the ring buffer. The stack buffer will not be overwritten.

Note

To ensure that the EMCY data is handled in a consistent way, it is necessary to set in BFM #20 bit 0 or 12 to ON before reading the EMCY data (FROM).

When clearing the entire buffer, write H0 to BFM #750.

BFM No.	Name	Description	
		High Byte	Low Byte
BFM #750	Node ID	The Node-ID number which sent the emergency message to the network is displayed.	
BFM #751	EMERGENCY data	Emergency error code ^{*1} (oldest message)	
BFM #752	EMERGENCY data	1st byte of Manufacturer-specific error code ^{*2}	Error register → For Error register (object H1001), refer to Subsection 5.6.2
BFM #753	EMERGENCY data	3rd byte of Manufacturer-specific error code ^{*2}	2nd byte of Manufacturer-specific error code ^{*2}
BFM #754	EMERGENCY data	5th byte of Manufacturer-specific error code ^{*2}	4th byte of Manufacturer-specific error code ^{*2}
⋮	⋮	⋮	⋮
BFM #800	Node ID	The Node-ID number which sent the emergency message to the network is displayed.	
BFM #801	EMERGENCY data	Emergency error code ^{*1}	
BFM #802	EMERGENCY data	1st byte of Manufacturer-specific error code ^{*2}	Error register → For Error register (object H1001), refer to Subsection 5.6.2
BFM #803	EMERGENCY data	3rd byte of Manufacturer-specific error code ^{*2}	2nd byte of Manufacturer-specific error code ^{*2}
BFM #804	EMERGENCY data	5th byte of Manufacturer-specific error code ^{*2} (newest message)	4th byte of Manufacturer-specific error code ^{*2} (newest message)
BFM #805	Node ID	The Node-ID number which sent the emergency message to the network is displayed. (oldest message)	
BFM #806	EMERGENCY data	Emergency error code ^{*1}	
BFM #807	EMERGENCY data	1st byte of Manufacturer-specific error code ^{*2}	Error register → For Error register (object H1001), refer to Subsection 5.6.2
BFM #808	EMERGENCY data	3rd byte of Manufacturer-specific error code ^{*2}	2nd byte of Manufacturer-specific error code ^{*2}
BFM #809	EMERGENCY data	5th byte of Manufacturer-specific error code ^{*2}	4th byte of Manufacturer-specific error code ^{*2}
⋮	⋮	⋮	⋮
BFM #855	Node ID	The Node-ID number which sent the emergency message to the network is displayed.	
BFM #856	EMERGENCY data	Emergency error code ^{*1}	
BFM #857	EMERGENCY data	1st byte of Manufacturer-specific error code ^{*2}	Error register → For Error register (object H1001), refer to Subsection 5.6.2
BFM #858	EMERGENCY data	3rd byte of Manufacturer-specific error code ^{*2}	2nd byte of Manufacturer-specific error code ^{*2}
BFM #859	EMERGENCY data	5th byte of Manufacturer-specific error code ^{*2} (newest message)	4th byte of Manufacturer-specific error code ^{*2} (newest message)

*1. Emergency error codes

In different CiA[®] Device/Application Profiles, more EMCY Error Codes are defined.

→ **For EMCY Error Codes that are not in the following table, refer to the manual of the device which sent the message**

Error Code (hex)	Description	Error Code (hex)	Description
0000	Error reset or no error	7000	Additional modules – generic error
0010	CiA [®] 417: CAN warning level	8000	Monitoring – generic error
1000	Generic error	8100	Communication – generic
2000	Current – generic error	8110	CAN overrun (objects lost)
2100	Current, CANopen [®] device input side – generic	8120	CAN in error passive mode
2200	Current inside the CANopen [®] device – generic	8130	Life guard error or heartbeat error
2300	Current, CANopen [®] device output side – generic	8140	Recovered from bus off
3000	Voltage – generic error	8150	CAN-ID collision
3100	Mains voltage – generic	8F01 to 8F7F	Life guard error or heartbeat error caused by Node-ID 1 to Node-ID 127.
3111	CiA [®] 417: Mains Over voltage	8200	Protocol error – generic
3121	CiA [®] 417: Mains Under voltage	8210	PDO not processed due to length error
3200	Voltage inside the CANopen [®] device – generic	8220	PDO length exceeded
3211	CiA [®] 417: Over voltage (device internal)	8230	DAM MPDO not processed, destination object not available
3221	CiA [®] 417: Under voltage (device internal)	8240	Unexpected SYNC data length
3300	Output voltage – generic	8250	RPDO timeout
4000	Temperature – generic error	9000	External error – generic error
4100	Ambient temperature – generic	F000	Additional functions – generic error
4200	Device temperature – generic	FF00	Device specific – generic error* ²
5000	CANopen [®] device hardware – generic error	FF01	CiA [®] 417: Light barrier defect* ²
6000	CANopen [®] device software – generic error	FF02	CiA [®] 417: Finger protector defect* ²
6100	Internal software – generic	FF03	CiA [®] 417: Motion detection defect* ²
6200	User software – generic	FF04	CiA [®] 417: Application error, Manufacturer-specific error code: Byte 0 and 1 contain a Text error code, Byte 2 to 4 are reserved* ²
6300	Data set – generic		

*2. EMCY Manufacturer specific error codes

EMCY Manufacturer specific error codes of the FX3U-CAN are shown below. EMCY Manufacturer Specific error codes are expressed by five ASCII code characters. However, the lower 2 bytes of the Manufacturer Specific Error code corresponding to Emergency Error Code "8250" uses four hexadecimal digits instead of ASCII code.

Emergency Error Code (hex)	Manufacturer Specific Error code (hex)					Description
	5th Byte	4th Byte	3rd Byte	2nd Byte	1st Byte	
FF00	46	58	30	30	31	"FX001": Main unit/CPU error occurs
FF00	46	58	30	30	32	"FX002": Main unit state changed from RUN to STOP Also occurs when the main unit is powered ON in the STOP state.
6200	46	58	30	30	33	"FX003": FROM/TO Watchdog expired
6200	46	58	30	30	34	"FX004": Module reset by BFM #25 bit 0 → For module reset, refer to Section 6.8
8250	50	44	4F	XX	XX	"PDO"X: RPDO Nr HXXXX Event Timer expired

6.24 [BFM #900 to #963] NMT Error Control Status

This BFM displays the Node Guarding and Heartbeat status.

Note

- When resetting the local NMT error latch, write H0 to the corresponding bit of this BFM.
- If bit 2 to 7 of any node is ON, BFM #29 bit 10 will be set.
- If the bit 10 in BFM #29 is reset to OFF, all failure bits in BFM #900 to #963 will be reset to OFF.

BFM No.	Description	
	High Byte	Low Byte
BFM #900	Node 2 status	Node 1 status
BFM #901	Node 4 status	Node 3 status
BFM #902	Node 6 status	Node 5 status
BFM #903	Node 8 status	Node 7 status
⋮	⋮	⋮
BFM #962	Node 126 status	Node 125 status
BFM #963	Unused (H0)	Node 127 status

Status Flags

Bit No.	Description	
Bit 0	Node guarding	Node Guarding is active
Bit 1	Heartbeat	Heartbeat is active. This bit is set after reception of the first Heartbeat message.
Bit 2	Node guarding	One node guarding message is missed or Toggle Bit error.
Bit 3	Node guarding	No response and Lifetime elapsed
Bit 4	NMT startup failed.	
Bit 5	Node guarding	The node does not have the expected state.
Bit 6	Node guarding	Guarding failed. Node Guarding remote requests of the NMT Master was not received in the expected time.
Bit 7	Heartbeat	Heartbeat is missing

7. CANopen® 405 Mode

7.1 Data Transfer Location for CANopen® 405 Mode

This section explains data transfer locations for CANopen® 405 mode. BFM #10000 to #10319 and #11000 to #11319 are used as data transfer locations.

Note

- The data will be exchanged only when the module is in OPERATIONAL State.
- To ensure that the FX3U-CAN module can handle the CANopen® data in a consistent way, it is necessary to use the data exchange by BFM #20 bit 0 or 8 to ON before reading PDO data (FROM) and after writing PDO data (TO) to the module.
The data exchange control signal ensures, by internal buffer exchange, that TO data from the PLC will be transmitted with its corresponding PDO at the same time.

7.1.1 Direct TO BFM Access to the CANopen® 405 Object

Use the TO instruction to write data to the following locations. The default TPDO mapping is assigned to unsigned 16 bit objects (Index HA100).

To change this setting, use the SDO command in the CIF or a CANopen® configuration software.

→ For SDO command in the CIF, refer to Section 10.2

→ For the CANopen® configuration software, refer to the manual of the software to be used

Note

The data which are written to the BFM will only be copied into the Object Dictionary when they are mapped into a PDO. Example: BFM #11000 is assigned to the Object Dictionary Indexes/Sub-indexes HA240/H01, HA200/H01, HA1C0/H01, HA100/H01, HA0C0/H01, HA040/H01, H02 and HA000/H01, H02. If none of these Indexes are mapped into a TPDO, the data will not be copied from the BFM into any of the assigned Object Dictionary Indexes/Sub-indexes.

Index HA240 float 32 bit object	Index HA200 unsigned 32 bit object	Index HA1C0 signed 32 bit object	Index HA100 unsigned 16 bit object	Index HA0C0 signed 16 bit object	Index HA040 unsigned 8 bit object	Index HA000 signed 8 bit object	Assigned BFM	
sub- index (hex)	sub- index (hex)	sub- index (hex)	sub- index (hex)	sub- index (hex)	sub- index (hex)	sub- index (hex)		
01	01	01	01	01	01	01	BFM #0 and #11000, lower 8 bit	
					02	02	BFM #0 and #11000, higher 8 bit	
			02	02	02	03	03	BFM #1 and #11001, lower 8 bit
						04	04	BFM #1 and #11001, higher 8 bit
02	02	02	03	03	05	05	BFM #2 and #11002, lower 8 bit	
					06	06	BFM #2 and #11002, higher 8 bit	
			04	04	04	07	07	BFM #3 and #11003, lower 8 bit
						08	08	BFM #3 and #11003, higher 8 bit
03	03	03	05	05	09	09	BFM #4 and #11004, lower 8 bit	
					0A	0A	BFM #4 and #11004, higher 8 bit	
			06	06	06	0B	0B	BFM #5 and #11005, lower 8 bit
						0C	0C	BFM #5 and #11005, higher 8 bit
⋮	⋮	⋮	⋮	⋮	⋮	⋮	⋮	

Index HA240 float 32 bit object	Index HA200 unsigned 32 bit object	Index HA1C0 signed 32 bit object	Index HA100 unsigned 16 bit object	Index HA0C0 signed 16 bit object	Index HA040 unsigned 8 bit object	Index HA000 signed 8 bit object	Assigned BFM
sub- index (hex)	sub- index (hex)	sub- index (hex)	sub- index (hex)	sub- index (hex)	sub- index (hex)	sub- index (hex)	
0A	0A	0A	13	13	25	25	BFM #18 and #11018, lower 8 bit
					26	26	BFM #18 and #11018, higher 8 bit
			14	14	27	27	BFM #19 and #11019, lower 8 bit
					28	28	BFM #19 and #11019, higher 8 bit
0B	0B	0B	15	15	29	29	BFM #100 and #11020, lower 8 bit
					2A	2A	BFM #100 and #11020, higher 8 bit
			16	16	2B	2B	BFM #101 and #11021, lower 8 bit
2C	2C	BFM #101 and #11021, higher 8 bit					
⋮	⋮	⋮	⋮	⋮	⋮	⋮	⋮
3C	3C	3C	77	77	ED	ED	BFM #198 and #11118, lower 8 bit
					EE	EE	BFM #198 and #11118, higher 8 bit
			78	78	EF	EF	BFM #199 and #11119, lower 8 bit
					F0	F0	BFM #199 and #11119, higher 8 bit

Index HA240 float 32 bit object	Index HA200 unsigned 32 bit object	Index HA1C0 signed 32 bit object	Index HA101 unsigned 16 bit object	Index HA0C1 signed 16 bit object	Index HA041 unsigned 8 bit object	Index HA001 signed 8 bit object	Assigned BFM
sub- index (hex)	sub- index (hex)	sub- index (hex)	sub- index (hex)	sub- index (hex)	sub- index (hex)	sub- index (hex)	
3D	3D	3D	01	01	01	01	BFM #200 and #11120, lower 8 bit
					02	02	BFM #200 and #11120, higher 8 bit
			02	02	03	03	BFM #201 and #11121, lower 8 bit
					04	04	BFM #201 and #11121, higher 8 bit
⋮	⋮	⋮	⋮	⋮	⋮	⋮	⋮
78	78	78	77	77	ED	ED	BFM #318 and #11238, lower 8 bit
					EE	EE	BFM #318 and #11238, higher 8 bit
			78	78	EF	EF	BFM #319 and #11239, lower 8 bit
					F0	F0	BFM #319 and #11239, higher 8 bit

Index HA240 float 32 bit object	Index HA200 unsigned 32 bit object	Index HA1C0 signed 32 bit object	Index HA102 unsigned 16 bit object	Index HA0C2 signed 16 bit object	Index HA042 unsigned 8 bit object	Index HA002 signed 8 bit object	Assigned BFM
sub- index (hex)	sub- index (hex)	sub- index (hex)	sub- index (hex)	sub- index (hex)	sub- index (hex)	sub- index (hex)	
79	79	79	01	01	01	01	BFM #320 and #11240, lower 8 bit
					02	02	BFM #320 and #11240, higher 8 bit
			02	02	03	03	BFM #321 and #11241, lower 8 bit
					04	04	BFM #321 and #11241, higher 8 bit
⋮	⋮	⋮	⋮	⋮	⋮	⋮	⋮
A0	A0	A0	4F	4F	9D	9D	BFM #398 and #11318, lower 8 bit
					9E	9E	BFM #398 and #11318, higher 8 bit
			50	50	9F	9F	BFM #399 and #11319, lower 8 bit
					A0	A0	BFM #399 and #11319, higher 8 bit

1

Introduction

2

Specifications

3

Installation

4

Wiring

5

Introduction of
Functions

6

Allocation of
Buffer Memories

7

Interface and
Device Profile
(405 mode)

8

Lift Application
Profile
(417 Mode)

9

CAN Layer 2
Mode

10

Command
Interface

7.1.2 Direct FROM BFM access to the CANopen® 405 Object

Use the FROM instruction to read data from the following locations. The default RPDO mapping is assigned to unsigned 16 bit objects (Index HA580).

To change this setting, use the SDO command in the CIF or a CANopen® configuration software.

→ For SDO command in the CIF, refer to Section 10.2

→ For the CANopen® configuration software, refer to the manual of the software to be used

Note

If data is written with an SDO into the Object Dictionary to one of the BFM corresponding Indexes/Sub-indexes, only the last data written is visible in the BFM. The data of the corresponding Indexes/Sub-indexes are not synchronized to each other.

Index HA6C0 float 32 bit object	Index HA680 unsigned 32 bit object	Index HA640 signed 32 bit object	Index HA580 unsigned 16 bit object	Index HA540 signed 16 bit object	Index HA4C0 unsigned 8 bit object	Index HA480 signed 8 bit object	Assigned BFM		
sub- index (hex)	sub- index (hex)	sub- index (hex)	sub- index (hex)	sub- index (hex)	sub- index (hex)	sub- index (hex)			
01	01	01	01	01	01	01	BFM #0 and #10000, lower 8 bit		
					02	02	BFM #0 and #10000, higher 8 bit		
			02	02	02	02	03	03	BFM #1 and #10001, lower 8 bit
							04	04	BFM #1 and #10001, higher 8 bit
02	02	02	03	03	05	05	BFM #2 and #10002, lower 8 bit		
					06	06	BFM #2 and #10002, higher 8 bit		
			04	04	04	04	07	07	BFM #3 and #10003, lower 8 bit
							08	08	BFM #3 and #10003, higher 8 bit
03	03	03	05	05	09	09	BFM #4 and #10004, lower 8 bit		
					0A	0A	BFM #4 and #10004, higher 8 bit		
			06	06	06	06	0B	0B	BFM #5 and #10005, lower 8 bit
							0C	0C	BFM #5 and #10005, higher 8 bit
⋮	⋮	⋮	⋮	⋮	⋮	⋮	⋮		
0A	0A	0A	13	13	25	25	BFM #18 and #10018, lower 8 bit		
					26	26	BFM #18 and #10018, higher 8 bit		
			14	14	14	14	27	27	BFM #19 and #10019, lower 8 bit
							28	28	BFM #19 and #10019, higher 8 bit
0B	0B	0B	15	15	29	29	BFM #100 and #10020, lower 8 bit		
					2A	2A	BFM #100 and #10020, higher 8 bit		
			16	16	16	16	2B	2B	BFM #101 and #10021, lower 8 bit
							2C	2C	BFM #101 and #10021, higher 8 bit
⋮	⋮	⋮	⋮	⋮	⋮	⋮	⋮		
3C	3C	3C	77	77	ED	ED	BFM #198 and #10118, lower 8 bit		
					EE	EE	BFM #198 and #10118, higher 8 bit		
			78	78	78	78	EF	EF	BFM #199 and #10119, lower 8 bit
							F0	F0	BFM #199 and #10119, higher 8 bit

Index HA6C0 float 32 bit object	Index HA680 unsigned 32 bit object	Index HA640 signed 32 bit object	Index HA581 unsigned 16 bit object	Index HA541 signed 16 bit object	Index HA4C1 unsigned 8 bit object	Index HA481 signed 8 bit object	Assigned BFM
sub- index (hex)	sub- index (hex)	sub- index (hex)	sub- index (hex)	sub- index (hex)	sub- index (hex)	sub- index (hex)	
3D	3D	3D	01	01	01	01	BFM #200 and #10120, lower 8 bit
					02	02	BFM #200 and #10120, higher 8 bit
			02	02	03	03	BFM #201 and #10121, lower 8 bit
					04	04	BFM #201 and #10121, higher 8 bit
⋮	⋮	⋮	⋮	⋮	⋮	⋮	⋮
78	78	78	77	77	ED	ED	BFM #318 and #10238, lower 8 bit
					EE	EE	BFM #318 and #10238, higher 8 bit
			78	78	EF	EF	BFM #319 and #10239, lower 8 bit
					F0	F0	BFM #319 and #10239, higher 8 bit

Index HA6C0 float 32 bit object	Index HA680 unsigned 32 bit object	Index HA640 signed 32 bit object	Index HA582 unsigned 16 bit object	Index HA542 signed 16 bit object	Index HA4C2 unsigned 8 bit object	Index HA482 signed 8 bit object	Assigned BFM
sub- index (hex)	sub- index (hex)	sub- index (hex)	sub- index (hex)	sub- index (hex)	sub- index (hex)	sub- index (hex)	
79	79	79	01	01	01	01	BFM #320 and #10240, lower 8 bit
					02	02	BFM #320 and #10240, higher 8 bit
			02	02	03	03	BFM #321 and #10241, lower 8 bit
					04	04	BFM #321 and #10241, higher 8 bit
⋮	⋮	⋮	⋮	⋮	⋮	⋮	⋮
A0	A0	A0	4F	4F	9D	9D	BFM #398 and #10318, lower 8 bit
					9E	9E	BFM #398 and #10318, higher 8 bit
			50	50	9F	9F	BFM #399 and #10319, lower 8 bit
					A0	A0	BFM #399 and #10319, higher 8 bit

1

Introduction

2

Specifications

3

Installation

4

Wiring

5

Introduction of
Functions

6

Allocation of
Buffer Memories

7

Interface and
Device Profile
(405 mode)

8

Lift Application
Profile
(417 Mode)

9

CAN Layer 2
Mode

10

Command
Interface

7.2 PDO Mapping/Binding of the Network for CANopen[®] 405 Mode

In order to exchange data by CANopen[®], the data channels between the nodes must be defined or "mapped". For large networks, the usage of a proper CANopen[®] network configuration tool^{*1} which is able to support easy parameter settings and PDO mapping is recommended.

To build up a small network or for testing purposes, the FX3U-CAN supports three PDO mapping/binding modes which can be executed by the Command Interface. By using these predefined Mapping configurations, the CAN object ID (COB-ID) number for data exchange of each node is clearly defined.

→ **For function mode setting for CANopen[®] 405 mode, refer to Section 6.5**

*1. Example: Vector ProCANopen

Note

It is strongly recommended to execute the Mapping Commands only in the Pre-operational mode of all related CANopen[®] nodes.

For a complete list of the assignment between the data BFM and the CANopen[®] data objects and their location in the Object Dictionary, refer to the following section.

→ **Refer to Subsection 7.2.1 and Subsection 7.2.2**

Note that the NMT Master startup process uses SDO's which can be result in an Error of the CIF SDO command if the NMT Startup Master accesses the remote Node at the same time.

7.2.1 TPDO mapping table

The assignment in this table is only for the default TPDO mapping setting (unsigned 16 bit objects). To change the BFM assignment of the TPDO, the mapping parameter has to be changed in the Object Dictionary.

- For the default TPDO mapping setting, refer to Subsection 7.1.1
- For the TPDO communication and mapping parameter in the Object Dictionary, refer to Subsection 5.6.5
- For the SDO command in the CIF, refer to Section 10.2
- For the CANopen® configuration software, refer to the manual of the software to be used

TPDO	Mode 0 Mapping (default)	Mode A Mapping	Mode B Mapping	Assigned BFM
	COB ID			
TPDO 1	H0180 + node ID		H0180 + node ID	#0 to #3 #11000 to #11003
TPDO 2	H0280 + node ID		H0280 + node ID	#4 to #7 #11004 to #11007
TPDO 3	H0380 + node ID		H0380 + node ID	#8 to #11 #11008 to #11011
TPDO 4	H0480 + node ID		H0480 + node ID	#12 to #15 #11012 to #11015
TPDO 5	Disabled These PDO can be activated by mode B mapping commands or SDO.			#16 to #19 #11016 to #11019
TPDO 6				#100 to #103 #11020 to #11023
TPDO 7				#104 to #107 #11024 to #11027
TPDO 8				#108 to #111 #11028 to #11031
TPDO 9				#112 to #115 #11032 to #11035
TPDO 10				#116 to #119 #11036 to #11039
TPDO 11				#120 to #123 #11040 to #11043
TPDO 12				#124 to #127 #11044 to #11047
TPDO 13				#128 to #131 #11048 to #11051
TPDO 14				#132 to #135 #11052 to #11055
TPDO 15				#136 to #139 #11056 to #11059
TPDO 16				#140 to #143 #11060 to #11063
TPDO 17				#144 to #147 #11064 to #11067
TPDO 18				#148 to #151 #11068 to #11071
TPDO 19				#152 to #155 #11072 to #11075
TPDO 20				#156 to #159 #11076 to #11079
TPDO 21				#160 to #163 #11080 to #11083
TPDO 22				#164 to #167 #11084 to #11087
TPDO 23				#168 to #171 #11088 to #11091
TPDO 24				#172 to #175 #11092 to #11095
TPDO 25				#176 to #179 #11096 to #11099

- 1 Introduction
- 2 Specifications
- 3 Installation
- 4 Wiring
- 5 Introduction of Functions
- 6 Allocation of Buffer Memories
- 7 Interface and Device Profile (405 Mode)
- 8 Lift Application Profile (417 Mode)
- 9 CAN Layer 2 Mode
- 10 Command Interface

TPDO	Mode 0 Mapping (default)	Mode A Mapping	Mode B Mapping	Assigned BFM
	COB ID			
TPDO 26	Disabled These PDO can be activated by mode B mapping commands or SDO.			#180 to #183 #11100 to #11103
TPDO 27				#184 to #187 #11104 to #11107
TPDO 28				#188 to #191 #11108 to #11111
TPDO 29				#192 to #195 #11112 to #11115
TPDO 30				#196 to #199 #11116 to #11119
TPDO 31				#200 to #203 #11120 to #11123
TPDO 32				#204 to #207 #11124 to #11127
TPDO 33				#208 to #211 #11128 to #11131
TPDO 34				#212 to #215 #11132 to #11135
TPDO 35				#216 to #219 #11136 to #11139
TPDO 36				#220 to #223 #11140 to #11143
TPDO 37				#224 to #227 #11144 to #11147
TPDO 38				#228 to #231 #11148 to #11151
TPDO 39				#232 to #235 #11152 to #11155
TPDO 40				#236 to #239 #11156 to #11159
TPDO 41				#240 to #243 #11160 to #11163
TPDO 42				#244 to #247 #11164 to #11167
TPDO 43				#248 to #251 #11168 to #11171
TPDO 44				#252 to #255 #11172 to #11175
TPDO 45				#256 to #259 #11176 to #11179
TPDO 46				#260 to #263 #11180 to #11183
TPDO 47				#264 to #267 #11184 to #11187
TPDO 48				#268 to #271 #11188 to #11191
TPDO 49				#272 to #275 #11192 to #11195
TPDO 50				#276 to #279 #11196 to #11199
TPDO 51				#280 to #283 #11200 to #11203
TPDO 52				#284 to #287 #11204 to #11207
TPDO 53				#288 to #291 #11208 to #11211
TPDO 54				#292 to #295 #11212 to #11215
TPDO 55				#296 to #299 #11216 to #11219

TPDO	Mode 0 Mapping (default)	Mode A Mapping	Mode B Mapping	Assigned BFM
	COB ID			
TPDO 56	<p style="text-align: center;">Disabled</p> <p style="text-align: center;">These PDO can be activated by mode B mapping commands or SDO.</p>			#300 to #303 #11220 to #11223
TPDO 57				#304 to #307 #11224 to #11227
TPDO 58				#308 to #311 #11228 to #11231
TPDO 59				#312 to #315 #11232 to #11235
TPDO 60				#316 to #319 #11236 to #11239
TPDO 61				#320 to #323 #11240 to #11243
TPDO 62				#324 to #327 #11244 to #11247
TPDO 63				#328 to #331 #11248 to #11251
TPDO 64				#332 to #335 #11252 to #11255
TPDO 65				#336 to #339 #11256 to #11259
TPDO 66				#340 to #343 #11260 to #11263
TPDO 67				#344 to #347 #11264 to #11267
TPDO 68				#348 to #351 #11268 to #11271
TPDO 69				#352 to #355 #11272 to #11275
TPDO 70				#356 to #359 #11276 to #11279
TPDO 71				#360 to #363 #11280 to #11283
TPDO 72				#364 to #367 #11284 to #11287
TPDO 73				#368 to #371 #11288 to #11291
TPDO 74				#372 to #375 #11292 to #11295
TPDO 75				#376 to #379 #11296 to #11299
TPDO 76				#380 to #383 #11300 to #11303
TPDO 77				#384 to #387 #11304 to #11307
TPDO 78				#388 to #391 #11308 to #11311
TPDO 79				#392 to #395 #11312 to #11315
TPDO 80				#396 to #399 #11316 to #11319

1

Introduction

2

Specifications

3

Installation

4

Wiring

5

Introduction of
Functions

6

Allocation of
Buffer Memories

7

Interface and
Device Profile
(405 mode)

8

Lift Application
Profile
(417 Mode)

9

CAN Layer 2
Mode

10

Command
Interface

7.2.2 RPDO mapping table

The assignment in this table is only for the default RPDO mapping setting (unsigned 16 bit objects). To change the BFM assignment of the RPDO, the mapping parameter has to be changed in the Object Dictionary.

→ For the default RPDO mapping setting, refer to Subsection 7.1.2

→ For the RPDO communication and mapping parameter in the Object Dictionary, refer to Subsection 5.6.5

→ For the SDO command in the CIF, refer to Section 10.2

→ For the CANopen® configuration software, refer to the manual of the software to be used

RPDO	Mode 0 Mapping (default)	Mode A Mapping		Mode B Mapping	Assigned BFM
	COB ID				
RPDO 1	H0200 + node ID	H0181	Node 1 data	Disabled Can be defined by mode B mapping command parameter or SDO.	#0 to #3 #10000 to #10003
RPDO 2	H0300 + node ID	H0281			#4 to #7 #10004 to #10007
RPDO 3	H0400 + node ID	H0381			#8 to #11 #10008 to #10011
RPDO 4	H0500 + node ID	H0481			#12 to #15 #10012 to #10015
RPDO 5	Disabled These PDO can be activated by mode B mapping commands or SDO.	H0182	Node 2 data		#16 to #19 #10016 to #10019
RPDO 6		H0282			#100 to #103 #10020 to #10023
RPDO 7		H0382			#104 to #107 #10024 to #10027
RPDO 8		H0482			#108 to #111 #10028 to #10031
RPDO 9		H0183	Node 3 data		#112 to #115 #10032 to #10035
RPDO 10		H0283			#116 to #119 #10036 to #10039
RPDO 11		H0383			#120 to #123 #10040 to #10043
RPDO 12		H0483			#124 to #127 #10044 to #10047
RPDO 13		H0184	Node 4 data		#128 to #131 #10048 to #10051
RPDO 14		H0284			#132 to #135 #10052 to #10055
RPDO 15		H0384			#136 to #139 #10056 to #10059
RPDO 16		H0484			#140 to #143 #10060 to #10063
RPDO 17	H0185	Node 5 data	#144 to #147 #10064 to #10067		
RPDO 18	H0285		#148 to #151 #10068 to #10071		
RPDO 19	H0385		#152 to #155 #10072 to #10075		
RPDO 20	H0485		#156 to #159 #10076 to #10079		
RPDO 21	H0186	Node 6 data	#160 to #163 #10080 to #10083		
RPDO 22	H0286		#164 to #167 #10084 to #10087		
RPDO 23	H0386		#168 to #171 #10088 to #10091		
RPDO 24	H0486		#172 to #175 #10092 to #10095		

RPDO	Mode 0 Mapping (default)	Mode A Mapping		Mode B Mapping	Assigned BFM
	COB ID				
RPDO 25	<p>Disabled These PDO can be activated by mode B mapping commands or SDO.</p> <p>Disabled These PDO can be activated by mode B mapping commands or SDO.</p>	H0187	Node 7 data	<p>Disabled Can be defined by mode B mapping command parameter or SDO.</p> <p>Disabled These PDO can be activated by mode B mapping commands or SDO.</p>	#176 to #179 #10096 to #10099
RPDO 26		H0287			#180 to #183 #10100 to #10103
RPDO 27		H0387			#184 to #187 #10104 to #10107
RPDO 28		H0487			#188 to #191 #10108 to #10111
RPDO 29		H0188	Node 8 data		#192 to #195 #10112 to #10115
RPDO 30		H0288			#196 to #199 #10116 to #10119
RPDO 31		H0388			#200 to #203 #10120 to #10123
RPDO 32		H0488			#204 to #207 #10124 to #10127
RPDO 33					#208 to #211 #10128 to #10131
RPDO 34					#212 to #215 #10132 to #10135
RPDO 35					#216 to #219 #10136 to #10139
RPDO 36					#220 to #223 #10140 to #10143
RPDO 37					#224 to #227 #10144 to #10147
RPDO 38					#228 to #231 #10148 to #10151
RPDO 39					#232 to #235 #10152 to #10155
RPDO 40					#236 to #239 #10156 to #10159
RPDO 41					#240 to #243 #10160 to #10163
RPDO 42					#244 to #247 #10164 to #10167
RPDO 43					#248 to #251 #10168 to #10171
RPDO 44					#252 to #255 #10172 to #10175
RPDO 45					#256 to #259 #10176 to #10179
RPDO 46					#260 to #263 #10180 to #10183
RPDO 47					#264 to #267 #10184 to #10187
RPDO 48					#268 to #271 #10188 to #10191
RPDO 49					#272 to #275 #10192 to #10195
RPDO 50					#276 to #279 #10196 to #10199
RPDO 51					#280 to #283 #10200 to #10203
RPDO 52					#284 to #287 #10204 to #10207
RPDO 53			#288 to #291 #10208 to #10211		
RPDO 54			#292 to #295 #10212 to #10215		

1

Introduction

2

Specifications

3

Installation

4

Wiring

5

Introduction of Functions

6

Allocation of Buffer Memories

7

Interface and Device Profile (405 mode)

8

Lift Application Profile (417 Mode)

9

CAN Layer 2 Mode

10

Command Interface

RPDO	Mode 0 Mapping (default)	Mode A Mapping	Mode B Mapping	Assigned BFM
	COB ID			
RPDO 55	<p>Disabled These PDO can be activated by mode B mapping commands or SDO.</p>		<p>Disabled Can be defined by mode B mapping command parameter or SDO.</p>	#296 to #299 #10216 to #10219
RPDO 56				#300 to #303 #10220 to #10223
RPDO 57				#304 to #307 #10224 to #10227
RPDO 58				#308 to #311 #10228 to #10231
RPDO 59				#312 to #315 #10232 to #10235
RPDO 60				#316 to #319 #10236 to #10239
RPDO 61				#320 to #323 #10240 to #10243
RPDO 62				#324 to #327 #10244 to #10247
RPDO 63				#328 to #331 #10248 to #10251
RPDO 64				#332 to #335 #10252 to #10255
RPDO 65				#336 to #339 #10256 to #10259
RPDO 66				#340 to #343 #10260 to #10263
RPDO 67				#344 to #347 #10264 to #10267
RPDO 68				#348 to #351 #10268 to #10271
RPDO 69				#352 to #355 #10272 to #10275
RPDO 70				#356 to #359 #10276 to #10279
RPDO 71				#360 to #363 #10280 to #10283
RPDO 72				#364 to #367 #10284 to #10287
RPDO 73				#368 to #371 #10288 to #10291
RPDO 74				#372 to #375 #10292 to #10295
RPDO 75				#376 to #379 #10296 to #10299
RPDO 76				#380 to #383 #10300 to #10303
RPDO 77				#384 to #387 #10304 to #10307
RPDO 78				#388 to #391 #10308 to #10311
RPDO 79				#392 to #395 #10312 to #10315
RPDO 80				#396 to #399 #10316 to #10319

7.2.3 Mode 0 mapping

By executing the Mode 0 mapping command shown below, the number of automatically assigned TPDOs and RPDOs becomes four. All RPDO/TPDO communication and mapping parameter and the BFM/Object dictionary assignment will be reset to factory default. The BFM content of the Receive/Transmit Process Data BFM's will be set to zero.

BFM #0 to #15 are distributed to RPDOs and TPDOs 1 to 4 as shown in the TPDO/RPDO mapping table. This setting is useful for a network that features many different types of nodes or as a base for a network mapping configured with the Mode B mapping command.

The PDOs 5 to 80 (BFM #16 to #19 and #100 to #399) are disabled in the default settings but further mapping of these PDOs can be accomplished by using the Mode B mapping technique or SDO.

- For RPDO/TPDO communication and mapping table, refer to Subsection 5.6.5
- For BFM assignment of the Receive/Transmit Process Data BFM's, refer to Subsection 7.1.1 and Subsection 7.1.2
- For Mode B COB-ID mapping command, refer to Subsection 7.2.5

Execution procedure: Mode 0 mapping

- 1) To execute the Mode 0 command, write H8900 to BFM #1000.
- 2) After the Mapping is successfully established, H8901 is written to BFM #1000.
→ In case of trouble, refer to Section 10.9

BFM No.	Description	
	FROM (Read Access)	TO (Write Access)
BFM #1000	H8901: Mapping successful established HFFFF: CIF Busy H000F: Error	Command: H8900
BFM #1001 to #1066	Unused	Unused

7.2.4 Mode A mapping

Easy setup of a CANopen® network of up to eight FX3U-CAN nodes can be accomplished by simply using the Mode A Mapping configuration. All FX3U-CAN modules have to be set up via the local PLC. One of the nodes must be configured as the network master. The network master can be defined in the Network Configuration tool or by writing to the Object Dictionary using the CIF SDO write command.

All RPDO/TPDO communication and mapping parameter and the BFM/Object dictionary assignment will be reset to Mode A default. The BFM content of the Receive/Transmit Process Data BFM's will be set to zero. The COB-IDs will be changed to the values shown in the tables in the Subsection 7.2.1 and Subsection 7.2.2. After all stations have executed the Mode A Mapping command, 16 data words can be exchanged with other FX3U-CAN modules.

A closer look at the mapping shows that the TPDO is dependent upon the node ID but the mapping for the RPDO is fixed to the default TPDO COB-ID of stations 1 to 8. The advantage is that the data location of all FX3U-CAN modules is the same.

To include non FX3U-CAN CANopen® nodes to the network, it is necessary to change the RPDO and communication parameters of these stations. This can be done by the Mode B mapping command, the SDO write access command, or by a standard configuration tool.

- For RPDO/TPDO communication and mapping table, refer to Subsection 5.6.5
- For SDO command in the CIF, refer to Section 10.2
- For the CANopen® configuration software, refer to the manual of the software to be used
- For BFM assignment of the Receive/Transmit Process Data BFM's, refer to Subsection 7.1.1 and Subsection 7.1.2
- For Mode B COB-ID mapping command, refer to Subsection 7.2.5

1

Introduction

2

Specifications

3

Installation

4

Wiring

5

Introduction of Functions

6

Allocation of Buffer Memories

7

Interface and Device Profile (405 Mode)

8

Lift Application Profile (417 Mode)

9

CAN Layer 2 Mode

10

Command Interface

Execution procedure: Mode A mapping

- 1) To execute the Mode A command, write H8200 to BFM #1000.
- 2) After the Mapping is successfully established, H8201 is written to BFM #1000.

→ In case of trouble, refer to Section 10.9

BFM No.	Description	
	FROM (Read Access)	TO (Write Access)
BFM #1000	H8201: Mapping successfully established H82FF: Local node number not in range 1 to 8 Local node number must be in the range 1 to 8 HFFFF: CiF Busy H000F: Error	Command: H8200
BFM #1001 to #1066	Unused	Unused

7.2.5 Mode B COB-ID mapping

With Mode B COB-ID Mapping, it is possible to build up bindings between any nodes connected to the FX3U-CAN module and the FX3U-CAN module itself or any other nodes also connected to the FX3U-CAN. Mode B COB-ID mapping is limited to the binding of the PDO COB-ID already configured in the remote stations (No change of the PDO mapping parameter).

All three Mode B COB-ID mapping options can be mixed within one CiF Function call.

Mode B COB-ID Mapping options	Reference
Reset Mapping Table to default Mode B COB-ID mapping	page 136
Assign Source TPDO COB-ID to Destination RPDO COB-ID	page 137
Assign Additional TPDO COB-IDs to the Local Node	page 138

The Mode B COB-ID mapping command will modify the current PDO COB-ID at the Destination, therefore it is important to have a clearly defined mapping base before executing any Mode B commands. Executing the Mode B COB-ID Mapping commands before adjusting the PDO mapping parameters (adjusting the PDO data length) may create errors in the data transmission or module operation.

The PDO mapping base can be the "Mode 0" mapping or the "Mode A" mapping explained in previous sections to prepare default RPDO and TPDO formats. Another method to create (or reset) a Mapping base is to initialize the Mode B Mapping with a special instruction at the beginning of the Mode B Mapping Command. If it is necessary to change the remote node hardware mapping, this can be done by the SDO write access command or by a standard CANopen® network configuration tool.

The configuration with the Mode B mapping is controlled by parameters, which are displayed in the table on the following page.

→ For the SDO write access command in the CiF, refer to Subsection 10.2.3

→ For BFM assignment of the Receive/Transmit Process Data BFM's, refer to Subsection 7.1.1 and Subsection 7.1.2

→ For the CANopen® configuration software, refer to the manual of the software to be used

→ For the default RPDO and TPDO formats, refer to Subsection 7.2.1 and Subsection 7.2.2

Reset Mapping Table to default Mode B COB-ID mapping

This command sets Mode B default settings on the local Node. All RPDO/TPDO communication and mapping parameter and the BFM/Object dictionary assignment will be reset to factory default. The BFM content of the Receive / Transmit Process Data BFM's will be set to zero. The COB-IDs will be changed to the values shown in the tables in the Subsection 7.2.1 and Subsection 7.2.2.

BFM No.	Description	
	FROM (Read Access)	TO (Write Access)
BFM #1000	H8301: Mapping successfully established HFFFF: CiF Busy H000F: Error	Command: H8300
BFM #1001	H0	H0
BFM #1002	H0	H0
BFM #1003	Other Mode B COB-ID mapping command response.	Other Mode B COB-ID mapping options or terminate with HFFFF in BFM #1003.
BFM #1066		

Assign Source TPDO COB-ID to Destination RPDO COB-ID

This command copies the COB-ID of the Source Node TPDO to the Destination Node RPDO. Please ensure that the PDO mapping parameter data fit together before executing this command. Otherwise it can result in communication failures and/or a malfunction of the Destination Node.

To change the PDO communication parameter or the PDO mapping parameter, please use the SDO command in the CIF or a CANopen® network configuration software.

→ For the SDO write access command in the CIF, refer to Subsection 10.2.3

→ For the CANopen® configuration software, refer to the manual of the software to be used

- Mode B TPDO/RPDO COB-ID Setup scenarios

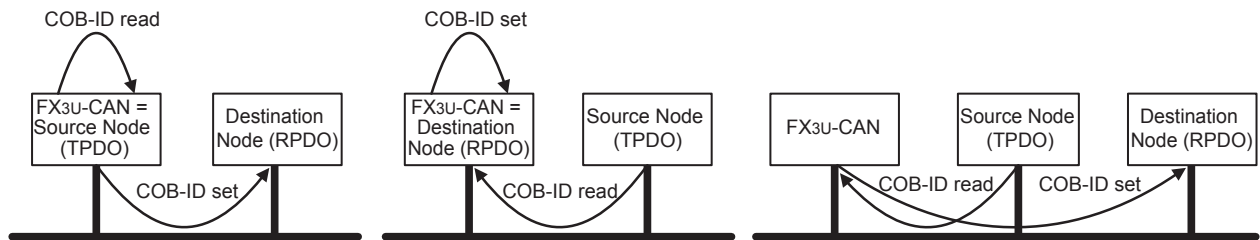

BFM No.	Description		
	FROM (Read Access)	TO (Write Access)	
		High Byte	Low Byte
BFM #1000	H8301: Mapping successfully established H83FF: Parameter Error HFFFF: CIF Busy H000F: Error	Command: H8300	
BFM #1001	Diagnosis Data H0000: No Error All other values: The corresponding parameter caused an error. → Refer to the Subsection 7.2.6	Node ID number of Source 1	Specific TPDO of Source 1
BFM #1002		Node ID number of Destination 1	Specific RPDO of Destination 1
...	
BFM #1063		Node ID number of Source 32	Specific TPDO of Source 32
BFM #1064		Node ID number of Destination 32	Specific RPDO of Destination 32
BFM #1065		Node ID number of Source 33	Specific TPDO of Source 33
BFM #1066		Node ID number of Destination 33	Specific RPDO of Destination 33

Note

With one execution of the Mode B COB-ID mapping command, up to 33 binding connections between CANopen® stations can be made. To establish more data connections, the command can be repeated as often as necessary.

IMPORTANT

If less than 33 bindings are used (max. number), the next BFM (n+1) needs to be terminated with HFFFF.

1. Source parameter

The Source parameter specifies the data telegram producer to be bound. It consists of two bytes, with the node ID in the high byte and the PDO number in the low byte.

- Node ID
The node ID range is 1 to 127.
The local FX3U-CAN can be specified by its actual node number or by using "0".
- TPDO number
The TPDO number setting range is 1 to 255.
The FX3U-CAN will read the TPDO COB-ID from the object dictionary of the source node. This COB-ID is written in the next step to the Destination node's RPDO communication parameter.

Example:

Source parameter = H1009

The high byte of the source parameter represents the node ID (H10). The low byte specifies TPDO 9. This node/TPDO will be bound to the node/RPDO in the destination BFM that directly follows the source BFM.

Note

An error will be generated if the Destination parameter is not configured.

- 1 Introduction
- 2 Specifications
- 3 Installation
- 4 Wiring
- 5 Introduction of Functions
- 6 Allocation of Buffer Memories
- 7 Interface and Device Profile (405 mode)
- 8 Lift Application Profile (417 Mode)
- 9 CAN Layer 2 Mode
- 10 Command Interface

2. Destination Parameter

The Destination parameter defines the destination for the corresponding source parameter data. It consists of two bytes, with the node ID in the high byte and the PDO number in the low byte.

- Node ID
The node ID range is 1 to 127.
The local FX3U-CAN can be specified by its actual node number or by using "0".
- RPDO number
The RPDO number setting range is 1 to 255.
The Destination node COB-ID is checked before the Source data is written to the communication parameter.

Example:

Destination parameter = H0203

The Source data will be bound to RPDO #3 of Node 2.

Note

An error message will be generated if the destination parameter is not configured.

Assign Additional TPDO COB-IDs to the Local Node

By default every CANopen® node uses four COB-IDs to exchange its data with other CANopen® stations. All COB-IDs for Data transmission are by default reserved for nodes 1 to 127. If it is necessary to transmit more than 4 PDOs (more than 16 words) from one node, this node must occupy COB-IDs of other (unused) stations. It is recommended to use the identifier of higher number stations for this purpose (127, 126, 125, etc). The lower the used COB-ID is, the higher the priority of the messages. Thus, assigning the COB-ID of TPDO4 from node 127 to highly important data should be avoided because all other TPDO COB-IDs have a higher priority for transmission on the CANopen® bus.

This command assigns the COB-ID of an unused TPDO of the Source Node to the defined TPDO of the local Node. Ensure that the Source Node doesn't exist in the network or that the Source Node TPDO is deactivated.

- Mode B TPDO/RPDO COB-ID Setup scenarios

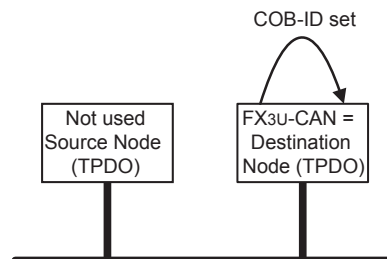

BFM No.	Description		
	FROM (Read Access)	TO (Write Access)	
		High Byte	Low Byte
BFM #1000	H8301: Mapping successfully established H83FF: Parameter Error HFFFF: CIF Busy H000F: Error	Command: H8300	
BFM #1001	Diagnosis Data H0000: No Error All other values: The corresponding parameter caused an error. → Refer to the Subsection 7.2.6	Node ID number of Source 1	Specific TPDO of Source 1
BFM #1002		Destination Node ID: H80	Specific TPDO of local Node 1
⋮		⋮	⋮
BFM #1063		Node ID number of Source 32	Specific TPDO of Source 32
BFM #1064		Destination Node ID: H80	Specific TPDO of local Node 32
BFM #1065		Node ID number of Source 33	Specific TPDO of Source 33
BFM #1066		Destination Node ID: H80	Specific TPDO of local Node 33

Note

With one execution of the Mode B COB-ID mapping command, up to 33 binding connections between CANopen® stations can be made. To establish more data connections, the command can be repeated as often as necessary.

IMPORTANT

If less than 33 bindings are used (max. number), the next two BFM's (n+1 and n+2) need to be terminated with HFFFF.

1. Source parameter

The Source parameter defines the node which is the default "owner" of the COB-ID. It consists of two bytes, with the node ID in the high byte and the PDO number in the low byte.

- Node ID
The node ID range is 1 to 127.
The local FX3U-CAN can't be the Source.
- TPDO number
The TPDO number setting range is 1 to 4.
This COB-ID is written to the local node's PDO communication parameter. The TPDO COB-ID is equal to: H0180 + Source node ID for TPDO1, H0280 + Source node ID for TPDO2, H0380 + Source node ID for TPDO3, H0480 + Source node ID for TPDO4.

2. Destination Parameter

The Destination parameter defines the destination for the corresponding source parameter data. It consists of two bytes, with the node ID in the high byte and the PDO number in the low byte.

- Node ID
The node ID must be set to H80.
- RPDO number
The TPDO number setting range is 5 to 80.

Example:

Source = H7F01, Destination = H8005

The local FX3U-CAN module will use the COB-ID of TPDO1 from node 127 as its own TPDO5 (COB-ID H1FF = H180 + H7F).

Note

- For default COB-IDs used for TPDO 1 to 4, refer to Subsection 5.6.1.
- An attempt to assign a COB-ID to the first four PDO will cause an error.
- A setting of the Source Node ID to the local node number will cause an error.

1

Introduction

2

Specifications

3

Installation

4

Wiring

5

Introduction of Functions

6

Allocation of Buffer Memories

7

Interface and Device Profile (405 mode)

8

Lift Application Profile (417 Mode)

9

CAN Layer 2 Mode

10

Command Interface

7.2.6 Mode B COB-ID Mapping Errors

This subsection describes the parameter error H83FF occurring in mode B COB-ID Mapping.

If the CIF was not able to execute the "mode B COB-ID Mapping" command with the given parameter set, it will return H83FF in BFM #1000. BFM #1001 to #1066 will show which parameter caused the error(s).

Example:

If the source parameter 5 (BFM #1009) caused an error, the return value of BFM #1009 will not be H0000.

1. Source Parameter Errors

If an error occurs in the Source Parameters, the error code in the following table is stored in BFM #1001 to #1066 as diagnosis data. The "nn" part of the error code indicates Node ID, and the "mm" indicates PDO number.

Error No. (Hex)	Description
HFFFF	Node ID higher than 127, or PDO number is 0. Check the Node ID and PDO number.
Hnn00	No response from node "nn" (time out). Check the status of the Node ID "nn".
H00mm	COB-ID is H80000000 (PDO disabled)
Hnnmm	Node ID "nn" can not be accessed to PDO number "mm" in the communication parameter. Check that the PDO number is supported.

2. Destination Parameter Errors

If an error occurs in the Destination Parameters, the error code in the following table is stored in BFM #1001 to #1066 as diagnosis data. The "nn" part of the error code indicates Node ID, and the "mm" indicates PDO number.

Error No. (Hex)	Description
HFFFF	The following states are possible. Check the Node ID and PDO number. <ul style="list-style-type: none"> Node ID higher than 127. PDO number is 0. The parameter may have been skipped if a Source error occurred.
Hnn00	No response from node ID "nn" (time out). Check the status of the Node ID "nn".
H00mm	Previous COB-ID of destination was H80000000. RPDO was disabled. Binding was accomplished, but there might be an error in the RPDO mapping parameter for the destination node.*1
Hnnmm	Node ID "nn" can not be accessed to PDO number "mm" in the communication parameter. Check the PDO number is supported.

*1. Please take care with this error message.

If the RPDO in the destination is disabled, it is uncertain whether there exists some mapping inside the destination node for this RPDO. This node might receive the data, but it is maybe not transferred to any I/O or data register.

When the Destination node is an FX3U-CAN, the PDO data will be mapped to a BFM (if the mapping parameter was not changed previously). In the case of the FX3U-CAN, the error can be judged as a warning that can be completely avoided if the mapping is done by the remote FX3U-CAN node itself.

Another possibility is to set the remote FX3U-CAN to Mode A mapping. In this case, RPDO 1 to 32 COB-IDs are different from H80000000. The disadvantage is that if all RPDO are mapped, they will also be received. This is not really a problem, but the FX3U-CAN cycle time will be a little bit longer, and it may be confusing if unused BFM are also changing their data values.

Note

If the local FX3U-CAN is the destination, error H00mm is disabled.

3. Other Errors

If the parameter is not set properly, the error code in the following table is stored in BFM #1001 to #1066 as diagnosis data. The "nn" part of the error code indicates Node ID and the "mm" indicates PDO number.

Error No. (Hex)	Description
Hnnmm	Source node ID "nn" must be in the range 1 to 127, PDO number "mm" must be 1 to 4 for the source parameter and 5 to 127 for the destination parameter.

8. CANopen® 417 Mode

This chapter describes the data transfer locations of the CANopen® 417 Mode.

For further information on application Profile CiA® 417 V2.1 for lift control systems, refer to the following section.

→ Refer to Section 5.10

Note

- The BFM data exchange will only be handled if the corresponding lift number bit in BFM #3000/13000 is set to ON.
→ Refer to Subsection 5.10.1 and BFM #3000/13000 in the following table.
- To ensure that the FX3U-CAN module can handle the CANopen® data in a consistent way, it is necessary to set BFM #20 bit 0, 8 or 9 (only Virtual input mapping) to ON before reading PDO data (FROM) and after writing PDO data (TO) to the module.
The data exchange control signal ensures, by internal buffer exchange, that TO data from the PLC will be transmitted with its corresponding PDO at the same time.
→ For BFM #20 bit 0, refer to Section 6.4
- To activate the CiA® 417 Lift Application Profile mode, write into BFM #21 the value K417, set BFM #22 to K1 to store the BFM configuration and reset the Module.
- Only BFMs corresponding to the Lift Numbers for which the module is activated will be received and transferred.
→ For the Lift number, refer to Subsection 5.10.1 and BFM #3000/13000 in the following table

8.1 Buffer Memories Lists of Lift Application

This section explains data transfer locations for CANopen® 417 Mode. BFM #3000 to #3539, BFM #13000 to 13539 and BFM #12001 to 12539 are used as data transfer locations.

- General Setting

BFM No. and access type		Lift No.	Description	Initial value	Reference
FROM	TO				
BFM #3000	BFM #13000	1 to 8	Lift Number	H1	Section 8.2

- Call controller
The call controller receives all call requests from the input panels, and transmits the corresponding acknowledgements to the output panels.

- Receive Objects

BFM No. and access type		Lift No.	Description	Initial value	Reference
FROM	FROM				
BFM #3001	BFM #12001	1 to 8	Virtual input mapping	H0	Section 8.3
BFM #3002	BFM #12002				
BFM #3003	BFM #12003				
BFM #3004	BFM #12004	1 to 8	Virtual input mapping message counter	H0	-
BFM #3005	BFM #12005	Reserved		-	-
⋮	⋮				
BFM #3049	BFM #12049				

- Transmission Objects

BFM No. and access type		Lift No.	Description	Initial value	Reference
TO	FROM/TO				
BFM #3001	BFM #13001	1 to 8	Virtual output mapping	H0	Section 8.3
BFM #3002	BFM #13002				
BFM #3003	BFM #13003				
BFM #3004	BFM #13004				
⋮	⋮	Reserved		-	-
BFM #3049	BFM #13049				

• Car door controller

The car door controller transmits commands (e.g. open and close) to the car door unit and receives status information from the car door unit and the light barrier unit.

- Receive Objects

BFM No. and access type		Lift No.	Description	Initial value	Reference	
FROM	FROM					
BFM #3050	BFM #12050	1	Door status word	HFFFF	Section 8.4	
BFM #3051	BFM #12051					Door 1
BFM #3052	BFM #12052					Door 2
BFM #3053	BFM #12053					Door 3
BFM #3054	BFM #12054	2	Door status word	HFFFF		
BFM #3055	BFM #12055					Door 1
BFM #3056	BFM #12056					Door 2
BFM #3057	BFM #12057					Door 3
BFM #3058	BFM #12058	3	Door status word	HFFFF		
BFM #3059	BFM #12059					Door 1
BFM #3060	BFM #12060					Door 2
BFM #3061	BFM #12061					Door 3
BFM #3062	BFM #12062	4	Door status word	HFFFF		
BFM #3063	BFM #12063					Door 1
BFM #3064	BFM #12064					Door 2
BFM #3065	BFM #12065					Door 3
BFM #3066	BFM #12066	5	Door status word	HFFFF		
BFM #3067	BFM #12067					Door 1
BFM #3068	BFM #12068					Door 2
BFM #3069	BFM #12069					Door 3
BFM #3070	BFM #12070	6	Door status word	HFFFF		
BFM #3071	BFM #12071				Door 1	
BFM #3072	BFM #12072				Door 2	
BFM #3073	BFM #12073				Door 3	
BFM #3074	BFM #12074	7	Door status word	HFFFF		
BFM #3075	BFM #12075				Door 1	
BFM #3076	BFM #12076				Door 2	
BFM #3077	BFM #12077				Door 3	
BFM #3078	BFM #12078	8	Door status word	HFFFF		
BFM #3079	BFM #12079				Door 1	
BFM #3080	BFM #12080				Door 2	
BFM #3081	BFM #12081				Door 3	
BFM #3082	BFM #12082	1	Door position	HFFFF	Section 8.5	
BFM #3083	BFM #12083					Door 1
BFM #3084	BFM #12084					Door 2
BFM #3085	BFM #12085					Door 3

BFM No. and access type		Lift No.	Description	Initial value	Reference	
FROM	FROM					
BFM #3086	BFM #12086	2	Door position	HFFFF	Section 8.5	
BFM #3087	BFM #12087					Door 1
BFM #3088	BFM #12088					Door 2
BFM #3089	BFM #12089					Door 3
BFM #3090	BFM #12090	3	Door position	HFFFF		
BFM #3091	BFM #12091					Door 1
BFM #3092	BFM #12092					Door 2
BFM #3093	BFM #12093					Door 3
BFM #3094	BFM #12094	4	Door position	HFFFF		
BFM #3095	BFM #12095					Door 1
BFM #3096	BFM #12096					Door 2
BFM #3097	BFM #12097					Door 3
BFM #3098	BFM #12098	5	Door position	HFFFF		
BFM #3099	BFM #12099					Door 1
BFM #3100	BFM #12100					Door 2
BFM #3101	BFM #12101					Door 3
BFM #3102	BFM #12102	6	Door position	HFFFF		
BFM #3103	BFM #12103				Door 1	
BFM #3104	BFM #12104				Door 2	
BFM #3105	BFM #12105				Door 3	
BFM #3106	BFM #12106	7	Door position	HFFFF		
BFM #3107	BFM #12107				Door 1	
BFM #3108	BFM #12108				Door 2	
BFM #3109	BFM #12109				Door 3	
BFM #3110	BFM #12110	8	Door position	HFFFF		
BFM #3111	BFM #12111				Door 1	
BFM #3112	BFM #12112				Door 2	
BFM #3113	BFM #12113				Door 3	
BFM #3114	BFM #12114	1	Light barrier status	HFF		
BFM #3115	BFM #12115				Door 1	
BFM #3116	BFM #12116				Door 2	
BFM #3117	BFM #12117				Door 3	
BFM #3118	BFM #12118	2	Light barrier status	HFF		
BFM #3119	BFM #12119				Door 1	
BFM #3120	BFM #12120				Door 2	
BFM #3121	BFM #12121				Door 3	
BFM #3122	BFM #12122	3	Light barrier status	HFF		
BFM #3123	BFM #12123				Door 1	
BFM #3124	BFM #12124				Door 2	
BFM #3125	BFM #12125				Door 3	
BFM #3126	BFM #12126	4	Light barrier status	HFF		
BFM #3127	BFM #12127				Door 1	
BFM #3128	BFM #12128				Door 2	
BFM #3129	BFM #12129				Door 3	
BFM #3130	BFM #12130	5	Light barrier status	HFF		
BFM #3131	BFM #12131				Door 1	
BFM #3132	BFM #12132				Door 2	
BFM #3133	BFM #12133				Door 3	
BFM #3134	BFM #12134	6	Light barrier status	HFF		
BFM #3135	BFM #12135				Door 1	
BFM #3136	BFM #12136				Door 2	
BFM #3137	BFM #12137				Door 3	

1	Introduction
2	Specifications
3	Installation
4	Wiring
5	Introduction of Functions
6	Allocation of Buffer Memories
7	Interface and Device Profile (405 mode)
8	Lift Application Profile (417 Mode)
9	CAN Layer 2 Mode
10	Command Interface

BFM No. and access type		Lift No.	Description	Initial value	Reference	
FROM	FROM					
BFM #3138	BFM #12138	7	Light barrier status	HFF	Section 8.6	
BFM #3139	BFM #12139					Door 1
BFM #3140	BFM #12140					Door 2
BFM #3141	BFM #12141					Door 3
BFM #3142	BFM #12142	8	Light barrier status	HFF		
BFM #3143	BFM #12143					Door 1
BFM #3144	BFM #12144					Door 2
BFM #3145	BFM #12145					Door 3
BFM #3146	BFM #12146	Reserved		-		
⋮	⋮					
BFM #3299	BFM #12299					

- Transmission Objects

BFM No. and access type		Lift No.	Description	Initial value	Reference	
TO	FROM/TO					
BFM #3050	BFM #13050	1	Door control word	HFFFF	Section 8.4	
BFM #3051	BFM #13051					Door 1
BFM #3052	BFM #13052					Door 2
BFM #3053	BFM #13053					Door 3
BFM #3054	BFM #13054	2	Door control word	HFFFF		
BFM #3055	BFM #13055					Door 1
BFM #3056	BFM #13056					Door 2
BFM #3057	BFM #13057					Door 3
BFM #3058	BFM #13058	3	Door control word	HFFFF		
BFM #3059	BFM #13059					Door 1
BFM #3060	BFM #13060					Door 2
BFM #3061	BFM #13061					Door 3
BFM #3062	BFM #13062	4	Door control word	HFFFF		
BFM #3063	BFM #13063					Door 1
BFM #3064	BFM #13064					Door 2
BFM #3065	BFM #13065					Door 3
BFM #3066	BFM #13066	5	Door control word	HFFFF		
BFM #3067	BFM #13067				Door 1	
BFM #3068	BFM #13068				Door 2	
BFM #3069	BFM #13069				Door 3	
BFM #3070	BFM #13070	6	Door control word	HFFFF		
BFM #3071	BFM #13071				Door 1	
BFM #3072	BFM #13072				Door 2	
BFM #3073	BFM #13073				Door 3	
BFM #3074	BFM #13074	7	Door control word	HFFFF		
BFM #3075	BFM #13075				Door 1	
BFM #3076	BFM #13076				Door 2	
BFM #3077	BFM #13077				Door 3	
BFM #3078	BFM #13078	8	Door control word	HFFFF		
BFM #3079	BFM #13079				Door 1	
BFM #3080	BFM #13080				Door 2	
BFM #3081	BFM #13081				Door 3	
BFM #3082	BFM #13082	Reserved		-		
⋮	⋮					
BFM #3299	BFM #13299					

- Car drive controller

The car drive controller transmits commands to the car drive unit. It receives status information from the car drive unit and the loadmeasuring unit. If the profile position mode is used, the car drive controller needs additional status information from the car position unit.

The car drive controller uses the Door position which is also used by the car door controller.

- Receive Objects

BFM No. and access type		Lift No.	Description	Initial value	Reference
FROM	FROM				
BFM #3300	BFM #12300	1	Position value	Position unit 1	HFFFFFFF
BFM #3301	BFM #12301			Position unit 2	
BFM #3302	BFM #12302			Position unit 3	
BFM #3303	BFM #12303			Position unit 4	
BFM #3304	BFM #12304				
BFM #3305	BFM #12305				
BFM #3306	BFM #12306				
BFM #3307	BFM #12307	2	Position value	Position unit 1	HFFFFFFF
BFM #3308	BFM #12308			Position unit 2	
BFM #3309	BFM #12309			Position unit 3	
BFM #3310	BFM #12310			Position unit 4	
BFM #3311	BFM #12311				
BFM #3312	BFM #12312				
BFM #3313	BFM #12313				
BFM #3314	BFM #12314	3	Position value	Position unit 1	HFFFFFFF
BFM #3315	BFM #12315			Position unit 2	
BFM #3316	BFM #12316			Position unit 3	
BFM #3317	BFM #12317			Position unit 4	
BFM #3318	BFM #12318				
BFM #3319	BFM #12319				
BFM #3320	BFM #12320				
BFM #3321	BFM #12321	4	Position value	Position unit 1	HFFFFFFF
BFM #3322	BFM #12322			Position unit 2	
BFM #3323	BFM #12323			Position unit 3	
BFM #3324	BFM #12324			Position unit 4	
BFM #3325	BFM #12325				
BFM #3326	BFM #12326				
BFM #3327	BFM #12327				
BFM #3328	BFM #12328	5	Position value	Position unit 1	HFFFFFFF
BFM #3329	BFM #12329			Position unit 2	
BFM #3330	BFM #12330			Position unit 3	
BFM #3331	BFM #12331			Position unit 4	
BFM #3332	BFM #12332				
BFM #3333	BFM #12333				
BFM #3334	BFM #12334				
BFM #3335	BFM #12335	6	Position value	Position unit 1	HFFFFFFF
BFM #3336	BFM #12336			Position unit 2	
BFM #3337	BFM #12337			Position unit 3	
BFM #3338	BFM #12338			Position unit 4	
BFM #3339	BFM #12339				
BFM #3340	BFM #12340				
BFM #3341	BFM #12341				
BFM #3342	BFM #12342				
BFM #3343	BFM #12343				
BFM #3344	BFM #12344				
BFM #3345	BFM #12345				
BFM #3346	BFM #12346				
BFM #3347	BFM #12347				

Section 8.7

1 Introduction

2 Specifications

3 Installation

4 Wiring

5 Introduction of Functions

6 Allocation of Buffer Memories

7 Interface and Device Profile (405 mode)

8 Lift Application Profile (417 Mode)

9 CAN Layer 2 Mode

10 Command Interface

BFM No. and access type		Lift No.	Description	Initial value	Reference	
FROM	FROM					
BFM #3348	BFM #12348	7	Position value	HFFFFFFF	Section 8.7	
BFM #3349	BFM #12349					Position unit 1
BFM #3350	BFM #12350					Position unit 2
BFM #3351	BFM #12351					Position unit 3
BFM #3352	BFM #12352					Position unit 4
BFM #3353	BFM #12353					
BFM #3354	BFM #12354					
BFM #3355	BFM #12355					
BFM #3356	BFM #12356	8	Position value	HFFFFFFF	Section 8.7	
BFM #3357	BFM #12357					Position unit 1
BFM #3358	BFM #12358					Position unit 2
BFM #3359	BFM #12359					Position unit 3
BFM #3360	BFM #12360					Position unit 4
BFM #3361	BFM #12361					
BFM #3362	BFM #12362					
BFM #3363	BFM #12363					
BFM #3364	BFM #12364	1	Speed value car	H0	Section 8.8	
BFM #3365	BFM #12365					Position unit 1
BFM #3366	BFM #12366					Position unit 2
BFM #3367	BFM #12367					Position unit 3
BFM #3368	BFM #12368	2	Speed value car	H0	Section 8.8	
BFM #3369	BFM #12369					Position unit 1
BFM #3370	BFM #12370					Position unit 2
BFM #3371	BFM #12371					Position unit 3
BFM #3372	BFM #12372	3	Speed value car	H0	Section 8.8	
BFM #3373	BFM #12373					Position unit 1
BFM #3374	BFM #12374					Position unit 2
BFM #3375	BFM #12375					Position unit 3
BFM #3376	BFM #12376	4	Speed value car	H0	Section 8.8	
BFM #3377	BFM #12377					Position unit 1
BFM #3378	BFM #12378					Position unit 2
BFM #3379	BFM #12379					Position unit 3
BFM #3380	BFM #12380	5	Speed value car	H0	Section 8.8	
BFM #3381	BFM #12381					Position unit 1
BFM #3382	BFM #12382					Position unit 2
BFM #3383	BFM #12383					Position unit 3
BFM #3384	BFM #12384	6	Speed value car	H0	Section 8.8	
BFM #3385	BFM #12385					Position unit 1
BFM #3386	BFM #12386					Position unit 2
BFM #3387	BFM #12387					Position unit 3
BFM #3388	BFM #12388	7	Speed value car	H0	Section 8.8	
BFM #3389	BFM #12389					Position unit 1
BFM #3390	BFM #12390					Position unit 2
BFM #3391	BFM #12391					Position unit 3
BFM #3392	BFM #12392	8	Speed value car	H0	Section 8.8	
BFM #3393	BFM #12393					Position unit 1
BFM #3394	BFM #12394					Position unit 2
BFM #3395	BFM #12395					Position unit 3

BFM No. and access type		Lift No.	Description	Initial value	Reference	
FROM	FROM					
BFM #3396	BFM #12396	1	Acceleration value car	H0	Section 8.9	
BFM #3397	BFM #12397					Position unit 1
BFM #3398	BFM #12398					Position unit 2
BFM #3399	BFM #12399					Position unit 3
BFM #3400	BFM #12400	2	Acceleration value car	H0		
BFM #3401	BFM #12401					Position unit 1
BFM #3402	BFM #12402					Position unit 2
BFM #3403	BFM #12403					Position unit 3
BFM #3404	BFM #12404	3	Acceleration value car	H0		
BFM #3405	BFM #12405					Position unit 1
BFM #3406	BFM #12406					Position unit 2
BFM #3407	BFM #12407					Position unit 3
BFM #3408	BFM #12408	4	Acceleration value car	H0		
BFM #3409	BFM #12409					Position unit 1
BFM #3410	BFM #12410					Position unit 2
BFM #3411	BFM #12411					Position unit 3
BFM #3412	BFM #12412	5	Acceleration value car	H0		
BFM #3413	BFM #12413				Position unit 1	
BFM #3414	BFM #12414				Position unit 2	
BFM #3415	BFM #12415				Position unit 3	
BFM #3416	BFM #12416	6	Acceleration value car	H0		
BFM #3417	BFM #12417				Position unit 1	
BFM #3418	BFM #12418				Position unit 2	
BFM #3419	BFM #12419				Position unit 3	
BFM #3420	BFM #12420	7	Acceleration value car	H0		
BFM #3421	BFM #12421				Position unit 1	
BFM #3422	BFM #12422				Position unit 2	
BFM #3423	BFM #12423				Position unit 3	
BFM #3424	BFM #12424	8	Acceleration value car	H0		
BFM #3425	BFM #12425				Position unit 1	
BFM #3426	BFM #12426				Position unit 2	
BFM #3427	BFM #12427				Position unit 3	
BFM #3428	BFM #12428	1	Status word	H0	Section 8.10	
BFM #3429	BFM #12429	2				
BFM #3430	BFM #12430	3				
BFM #3431	BFM #12431	4				
BFM #3432	BFM #12432	5				
BFM #3433	BFM #12433	6				
BFM #3434	BFM #12434	7				
BFM #3435	BFM #12435	8				
BFM #3436	BFM #12436	1	Modes of operation display	H0	Section 8.11	
BFM #3437	BFM #12437	2				
BFM #3438	BFM #12438	3				
BFM #3439	BFM #12439	4				
BFM #3440	BFM #12440	5				
BFM #3441	BFM #12441	6				
BFM #3442	BFM #12442	7				
BFM #3443	BFM #12443	8				

1

Introduction

2

Specifications

3

Installation

4

Wiring

5

Introduction of Functions

6

Allocation of Buffer Memories

7

Interface and Device Profile (405 mode)

8

Lift Application Profile (417 Mode)

9

CAN Layer 2 Mode

10

Command Interface

BFM No. and access type		Lift No.	Description	Initial value	Reference
FROM	FROM				
BFM #3444	BFM #12444	1	Control effort	H0	Section 8.12
BFM #3445	BFM #12445				
BFM #3446	BFM #12446	2			
BFM #3447	BFM #12447				
BFM #3448	BFM #12448	3			
BFM #3449	BFM #12449				
BFM #3450	BFM #12450	4			
BFM #3451	BFM #12451				
BFM #3452	BFM #12452	5			
BFM #3453	BFM #12453				
BFM #3454	BFM #12454	6			
BFM #3455	BFM #12455				
BFM #3456	BFM #12456	7			
BFM #3457	BFM #12457				
BFM #3458	BFM #12458	8			
BFM #3459	BFM #12459				
BFM #3460	BFM #12460	1	Position actual value	HFFFFFFF	Section 8.13
BFM #3461	BFM #12461				
BFM #3462	BFM #12462	2			
BFM #3463	BFM #12463				
BFM #3464	BFM #12464	3			
BFM #3465	BFM #12465				
BFM #3466	BFM #12466	4			
BFM #3467	BFM #12467				
BFM #3468	BFM #12468	5			
BFM #3469	BFM #12469				
BFM #3470	BFM #12470	6			
BFM #3471	BFM #12471				
BFM #3472	BFM #12472	7			
BFM #3473	BFM #12473				
BFM #3474	BFM #12474	8			
BFM #3475	BFM #12475				
BFM #3476	BFM #12476	Reserved		-	-
⋮	⋮				
BFM #3491	BFM #12491	1	Velocity actual value	H0	Section 8.15
BFM #3492	BFM #12492				
BFM #3493	BFM #12493	2			
BFM #3494	BFM #12494				
BFM #3495	BFM #12495	3			
BFM #3496	BFM #12496				
BFM #3497	BFM #12497	4			
BFM #3498	BFM #12498				
BFM #3499	BFM #12499	5			
BFM #3500	BFM #12500				
BFM #3501	BFM #12501	6			
BFM #3502	BFM #12502				
BFM #3503	BFM #12503	7			
BFM #3504	BFM #12504				
BFM #3505	BFM #12505	8			
BFM #3506	BFM #12506				
BFM #3507	BFM #12507				

BFM No. and access type		Lift No.	Description	Initial value	Reference		
FROM	FROM						
BFM #3508	BFM #12508	1	Load value	Absolute load value	HFFFF	Section 8.16	
BFM #3509	BFM #12509			SI unit	H2		
BFM #3510	BFM #12510	2	Load value	Absolute load value	HFFFF		
BFM #3511	BFM #12511			SI unit	H2		
BFM #3512	BFM #12512	3	Load value	Absolute load value	HFFFF		
BFM #3513	BFM #12513			SI unit	H2		
BFM #3514	BFM #12514	4	Load value	Absolute load value	HFFFF		
BFM #3515	BFM #12515			SI unit	H2		
BFM #3516	BFM #12516	5	Load value	Absolute load value	HFFFF		
BFM #3517	BFM #12517			SI unit	H2		
BFM #3518	BFM #12518	6	Load value	Absolute load value	HFFFF		
BFM #3519	BFM #12519			SI unit	H2		
BFM #3520	BFM #12520	7	Load value	Absolute load value	HFFFF		
BFM #3521	BFM #12521			SI unit	H2		
BFM #3522	BFM #12522	8	Load value	Absolute load value	HFFFF		
BFM #3523	BFM #12523			SI unit	H2		
BFM #3524	BFM #12524	1	Load signalling	Load signal	H0		Section 8.17
BFM #3525	BFM #12525			Load signal interrupt	H0		
BFM #3526	BFM #12526	2	Load signalling	Load signal	H0		
BFM #3527	BFM #12527			Load signal interrupt	H0		
BFM #3528	BFM #12528	3	Load signalling	Load signal	H0		
BFM #3529	BFM #12529			Load signal interrupt	H0		
BFM #3530	BFM #12530	4	Load signalling	Load signal	H0		
BFM #3531	BFM #12531			Load signal interrupt	H0		
BFM #3532	BFM #12532	5	Load signalling	Load signal	H0		
BFM #3533	BFM #12533			Load signal interrupt	H0		
BFM #3534	BFM #12534	6	Load signalling	Load signal	H0		
BFM #3535	BFM #12535			Load signal interrupt	H0		
BFM #3536	BFM #12536	7	Load signalling	Load signal	H0		
BFM #3537	BFM #12537			Load signal interrupt	H0		
BFM #3538	BFM #12538	8	Load signalling	Load signal	H0		
BFM #3539	BFM #12539			Load signal interrupt	H0		

- Transmission Objects

BFM No. and access type		Lift No.	Description	Initial value	Reference
TO	FROM/TO				
BFM #3300	BFM #13300	Reserved		-	-
⋮	⋮				
BFM #3427	BFM #13427				
BFM #3428	BFM #13428	1	Control word	H0	Section 8.10
BFM #3429	BFM #13429	2			
BFM #3430	BFM #13430	3			
BFM #3431	BFM #13431	4			
BFM #3432	BFM #13432	5			
BFM #3433	BFM #13433	6			
BFM #3434	BFM #13434	7			
BFM #3435	BFM #13435	8			

1

Introduction

2

Specifications

3

Installation

4

Wiring

5

Introduction of Functions

6

Allocation of Buffer Memories

7

Interface and Device Profile (405 mode)

8

Lift Application Profile (417 Mode)

9

CAN Layer 2 Mode

10

Command Interface

BFM No. and access type		Lift No.	Description	Initial value	Reference	
TO	FROM/TO					
BFM #3436	BFM #13436	1	Modes of operation	H0	Section 8.11	
BFM #3437	BFM #13437	2				
BFM #3438	BFM #13438	3				
BFM #3439	BFM #13439	4				
BFM #3440	BFM #13440	5				
BFM #3441	BFM #13441	6				
BFM #3442	BFM #13442	7				
BFM #3443	BFM #13443	8				
BFM #3444	BFM #13444	Reserved		-	-	
⋮	⋮					
BFM #3459	BFM #13459	1	Target position	H0	Section 8.13	
BFM #3460	BFM #13460					
BFM #3461	BFM #13461					
BFM #3462	BFM #13462					2
BFM #3463	BFM #13463					
BFM #3464	BFM #13464					3
BFM #3465	BFM #13465					
BFM #3466	BFM #13466					4
BFM #3467	BFM #13467					
BFM #3468	BFM #13468					5
BFM #3469	BFM #13469					
BFM #3470	BFM #13470					6
BFM #3471	BFM #13471					
BFM #3472	BFM #13472					7
BFM #3473	BFM #13473					
BFM #3474	BFM #13474					8
BFM #3475	BFM #13475					
BFM #3476	BFM #13476	1	Profile velocity	H0	Section 8.14	
BFM #3477	BFM #13477					
BFM #3478	BFM #13478					2
BFM #3479	BFM #13479					
BFM #3480	BFM #13480					3
BFM #3481	BFM #13481					
BFM #3482	BFM #13482					4
BFM #3483	BFM #13483					
BFM #3484	BFM #13484					5
BFM #3485	BFM #13485					
BFM #3486	BFM #13486					6
BFM #3487	BFM #13487					
BFM #3488	BFM #13488					7
BFM #3489	BFM #13489					
BFM #3490	BFM #13490					8
BFM #3491	BFM #13491					

BFM No. and access type		Lift No.	Description	Initial value	Reference
TO	FROM/TO				
BFM #3492	BFM #13492	1	Target velocity	H0	Section 8.15
BFM #3493	BFM #13493				
BFM #3494	BFM #13494	2			
BFM #3495	BFM #13495				
BFM #3496	BFM #13496	3			
BFM #3497	BFM #13497				
BFM #3498	BFM #13498	4			
BFM #3499	BFM #13499				
BFM #3500	BFM #13500	5			
BFM #3501	BFM #13501				
BFM #3502	BFM #13502	6			
BFM #3503	BFM #13503				
BFM #3504	BFM #13504	7			
BFM #3505	BFM #13505				
BFM #3506	BFM #13506	8			
BFM #3507	BFM #13507				
BFM #3508	BFM #13508	Reserved			
⋮	⋮				
BFM #3539	BFM #13539				

- 1** Introduction
- 2** Specifications
- 3** Installation
- 4** Wiring
- 5** Introduction of Functions
- 6** Allocation of Buffer Memories
- 7** Interface and Device Profile (405 mode)
- 8** Lift Application Profile (417 Mode)
- 9** CAN Layer 2 Mode
- 10** Command Interface

8.2 Lift Number

This BFM contains the lift number to which the FX3U-CAN is assigned.
The Bit for the assigned lift number is set to ON (1).

Note

Only the application BFMs for which the Lift corresponding bit is set will be updated.

Data save to Flash ROM

Data can be saved in Flash ROM by CIF.

→ For Store Object Dictionary Settings in the CIF, refer to Section 10.6

BFM No.	Description										
	Bit 15	Bit 8	Bit 7	Bit 6	Bit 5	Bit 4	Bit 3	Bit 2	Bit 1	Bit 0
BFM #3000 BFM #13000	Reserved			Lift 8	Lift 7	Lift 6	Lift 5	Lift 4	Lift 3	Lift 2	Lift 1

8.3 Virtual Input/Output Mapping

When BFM #3001 to #3003 and #12001 to #12003 are read, the virtual input mapping information is read from BFMs. When BFM #13001 to #13003 are read, the virtual output mapping information is read from BFMs. And when BFM #3001 to #3003 and #13001 to #13003 are written to, the virtual output mapping information is written to BFMs.

8.3.1 Virtual input mapping

These BFMs contain the last received input data from one of the digital input panel group objects. Receive Ring Buffer for 252 messages. The oldest data will be shown as first.
The current numbers of messages in the receive Buffer can be read from BFM #3004 or #12004.
When the receive buffer is empty, BFM #3001 to #3003 or #12001 to #12003 shows the value H0.

BFM No.	Description					
	BFM #3003 BFM #12003		BFM #3002 BFM #12002		BFM #3001 BFM #12001	
	High Byte	Low Byte	High Byte	Low Byte	High Byte	Low Byte
BFM #3001 to #3003 BFM #12001 to #12003	Function data field	Door field	Floor field	Lift field	Sub-function field	Basic function field

1. Basic function field [Low byte in BFM #3001 and #12001]

BFM #3001 BFM #12001 Low Byte Value (hex)	Description
00	Reserved
01	Generic input
02	Standard hall call request
03	Low priority hall call request
04	High priority hall call request
05	Standard car call request
06	Low priority car call request
07	High priority car call request
08	Standard destination call
09	Low priority destination call
0A	High priority destination call
0B	Standard call to destination floor
0C	Low priority call to destination floor

BFM #3001 BFM #12001 Low Byte Value (hex)	Description
0D	High priority call to destination floor
0E	Special function
0F	Access code upload request
10	Speech connection request
11	Area monitoring connection request
12	Fire detector
13 to 15	Reserved
16	Status of safety-related circuitries (This is not safety-related information.)
17 to 1F	Reserved
20	Guest call
21 to 7F	Reserved
80 to FF	Manufacturer-specific

2. Sub-function field [High byte in BFM #3001 and #12001]

The Sub-function field interprets depending on the basic function field value.

Basic Function Field	Sub-Function Field	Description	Basic Function Field	Sub-Function Field	Description	
BFM #3001 BFM #12001 Low Byte Value (hex)	BFM #3001 BFM #12001 High Byte Value (hex)		BFM #3001 BFM #12001 Low Byte Value (hex)	BFM #3001 BFM #12001 High Byte Value (hex)		
01	00	Reserved	0E	12	Special service	
	01	Generic input 1		13	Service run	
	⋮	⋮		14	Dogging service enable	
	FE	Generic input 254		15	Dogging service up	
	FF	Reserved		16	Dogging service down	
02 to 04	00	Reserved		17	Fire alarm (external fire alarm system)	
	01	Hall call up		18	Provide priority	
	02	Hall call down		19	Lift attendant start button	
	03	Hall call		1A	Lift attendant drive through button	
	04	Hall call extra up		1B	Security run	
	05	Hall call extra down		1C	Second call panel	
	06	Hall call extra		1D	Door enable	
	07 to FF	Reserved		1E	Call cancel button fire operation	
05 to 0D	00	Reserved		1F	Fire alarm reset	
	01 to FE	Floor number 1 to 254		20	Body detector (e.g. person in car)	
	FF	Reserved		21	Earthquake detector	
0E	00	Reserved		22 to FF	Reserved	
	01	Request fan 1		0F to 11	00 to FF	Reserved
	02	Request fan 2		12	00	Reserved
	03	Request load time 1			01 to FE	Fire detector 1 to 254
	04	Request load time 2	FF	Reserved		
	05	Key lock 1	13 to 15	00 to FF	Reserved	
	06	Key lock 2		00	Reserved	
	07	Key lock 3	16	01 to 03	Safety-related circuitry 1 to 3	
	08	Key lock 4		04	Hall/swing door	
	09	Request door open		05	Car door	
	0A	Request door close		06	Door lock	
	0B	Fire recall (key switch hall panel)	17 to 1F	07 to FF	Reserved	
	0C	Fire service (key switch car panel)		00 to FF	Reserved	
	0D	Hall call disable	20	00	Reserved	
	0E	Attendant service		01 to FE	Guest call 1 to 254	
	0F	VIP service		FF	Reserved	
	10	Out of order	21 to 7F	00 to FF	Reserved	
11	Bed passenger service	80 to FF	00 to FF	Manufacturer-specific		

3. Lift field [Low byte in BFM #3002 and #12002]

The bit for the requested lift number is set to ON (1).

BFM #3002 BFM #12002 Low Byte	Description							
	Bit 7	Bit 6	Bit 5	Bit 4	Bit 3	Bit 2	Bit 1	Bit 0
BFM #3002 Bit 0 to 7	Lift 8	Lift 7	Lift 6	Lift 5	Lift 4	Lift 3	Lift 2	Lift 1

- 1 Introduction
- 2 Specifications
- 3 Installation
- 4 Wiring
- 5 Introduction of Functions
- 6 Allocation of Buffer Memories
- 7 Interface and Device Profile (405 mode)
- 8 Lift Application Profile (417 Mode)
- 9 CAN Layer 2 Mode
- 10 Command Interface

4. Floor field [High byte in BFM #3002 and #12002]

BFM #3002 BFM #12002 High Byte Value (hex)	Description
00	Car panel
01 to FE	Panel of floor 1 to 254
FF	Reserved

5. Door field [Low byte in BFM #3003 and #12003]

This value provides the door number to which the sending virtual device is assigned. The structure of the field depends on the value of the basic function field.

Basic Function Field	Door Field	Description
BFM #3001 BFM #12001 Low Byte Value (hex)	BFM #3003 BFM #12003 Low Byte Bit No.	
00 to 07 or 0E to FF	Bit 0	Door 1
	Bit 1	Door 2
	Bit 2	Door 3
	Bit 3	Door 4
	Bit 4 to 7	Bit 4 to 7 fixed to OFF (0).
08 to 0D	Bit 0	Source door 1
	Bit 1	Source door 2
	Bit 2	Source door 3
	Bit 3	Source door 4
	Bit 4	Destination door 1
	Bit 5	Destination door 2
	Bit 6	Destination door 3
	Bit 7	Destination door 4

6. Function data field [High byte in BFM #3003 and #12003]

The function data provides the input state of a virtual input.

BFM #3003 BFM #12003 (High Byte) Bit No.	Description			
Bit 8 and 9	Input state	Bit 9	Bit 8	Description
		OFF (0)	OFF (0)	Input state is OFF.
		OFF (0)	ON (1)	Input state is ON.
		ON (1)	OFF (0)	Function is defective
		ON (1)	ON (1)	Function is not installed
Bit 10 to 14	Reserved			
Bit 15	lock	OFF (0): Button or key-button has no locking function ON (1): Button or key-button has locking function		

8.3.2 Virtual output mapping

These BFM s contain the output data for one of the digital output group objects.

BFM No.	Description					
	BFM #3003 BFM #13003		BFM #3002 BFM #13002		BFM #3001 BFM #13001	
	High Byte	Low Byte	High Byte	Low Byte	High Byte	Low Byte
BFM #3001 to #3003 BFM #13001 to #13003	Function data field	Door field	Floor field	Lift field	Sub-function field	Basic function field

1. Basic function field [Low byte in BFM #3001 and #13001]

BFM #3001 BFM #13001 Low Byte Value (hex)	Description
00	Call controller commands
01	Generic output
02	Standard hall call acknowledgement
03	Low priority hall call acknowledgement
04	High priority hall call acknowledgement
05	Standard car call acknowledgement
06	Low priority car call acknowledgement
07	High priority car call acknowledgement
08	Standard destination call acknowledgement
09	Low priority destination call acknowledgement
0A	High priority destination call acknowledgement
0B	Standard call to destination floor acknowledgement
0C	Low priority call to destination floor acknowledgement
0D	High priority call to destination floor acknowledgement
0E	Special function acknowledgement
0F	Access code upload acknowledgement
10	Speech connection acknowledgement

BFM #3001 BFM #13001 Low Byte Value (hex)	Description
11	Area monitoring connection acknowledgement
12 to 1F	Reserved
20	Guest call acknowledgement
21 to 3F	Reserved
40	Position indication
41	Hall lantern
42	Direction indication
43	Special indication
44	Arrival indication
45	Operation data
46	Publicity indication
47	Speech synthesis
48 to 49	Reserved
4A	Miscellaneous outputs
4B to 7F	Reserved
80 to FF	Manufacturer-specific

2. Sub-function field [High byte in #3001 and #13001]

The Sub-function field is interpreted differently depending on the basic function field value.

Basic Function Field	Sub-Function Field	Description
BFM #3001 BFM #13001 Low Byte Value (hex)	BFM #3001 BFM #13001 High Byte Value (hex)	
00	00	Reserved
	01	Request all active hall calls
	02	Request all special inputs (basic functions 0E and 12)
	03 to FF	Reserved
01	00 to FF	Reserved
02 to 04	00	Reserved
	01	Hall call up acknowledgement
	02	Hall call down acknowledgement
	03	Hall call acknowledgement
	04	Hall call extra up acknowledgement
	05	Hall call extra down acknowledgement
	06	Hall call extra acknowledgement
	07 to FF	Reserved
05 to 0D	00	Reserved
	01 to FE	Target stop acknowledgement 1 to 254
	FF	All target stop buttons

- 1 Introduction
- 2 Specifications
- 3 Installation
- 4 Wiring
- 5 Introduction of Functions
- 6 Allocation of Buffer Memories
- 7 Interface and Device Profile (405 mode)
- 8 Lift Application Profile (417 Mode)
- 9 CAN Layer 2 Mode
- 10 Command Interface

Basic Function Field	Sub-Function Field	Description			
BFM #3001 BFM #13001 Low Byte Value (hex)	BFM #3001 BFM #13001 High Byte Value (hex)				
0E	00	Reserved			
	01	Request fan 1 acknowledgement			
	02	Request fan 2 acknowledgement			
	03	Request load time 1 acknowledgement			
	04	Request load time 2 acknowledgement			
	05	Request key lock 1 acknowledgement			
	06	Request key lock 2 acknowledgement			
	07	Request key lock 3 acknowledgement			
0E	08	Request key lock 4 acknowledgement			
	09	Request door open acknowledgement			
	0A	Request door close acknowledgement			
	0B	Fire recall (key switch hall panel) acknowledgement			
	0C	Fire service (key switch hall panel) acknowledgement			
	0D	Hall call disable acknowledgement			
	0E	Attendant service acknowledgement			
	0F	VIP service acknowledgement			
	10	Out of order acknowledgement			
	11	Bed passenger service acknowledgement			
	12	Special service acknowledgement			
	13	Service run acknowledgement			
	14	Dogging service enable acknowledgement			
	15	Dogging service up acknowledgement			
	16	Dogging service down acknowledgement			
	17	Fire alarm (external fire alarm system) acknowledgement			
	18	Provide priority acknowledgement			
	19	Lift attendant start button acknowledgement			
	1A	Lift attendant drive through button acknowledgement			
	1B	Security run acknowledgement			
	1C	Second call panel acknowledgement			
	1D	Door enable acknowledgement			
1E	Call cancel button fire operation				
1F	Fire alarm reset acknowledgement				
20	Body detector (e.g. person in car)				
21	Earthquake detector				
22 to FF	Reserved				
0F to 1F	00 to FF	Reserved			
20	00	Reserved			
	01 to FE	Guest call acknowledgement 1 to 254			
	FF	Reserved			
21 to 3F	00 to FF	Reserved			
40	00	Clear the floor data			
	01 to FE	Floor number 1 to 254			
	FF	Reserved			
41	This sub-function shows the arrow display direction up/down. Bit 15 ... 10 9 8 <table border="1" style="margin-left: 40px;"> <tr> <td style="width: 40px;">H0</td> <td style="width: 40px;">Down</td> <td style="width: 40px;">Up</td> </tr> </table> OFF (0): Do not display the arrow ON (1): Display the arrow		H0	Down	Up
H0	Down	Up			

Basic Function Field	Sub-Function Field	Description											
BFM #3001 BFM #13001 Low Byte Value (hex)	BFM #3001 BFM #13001 High Byte Value (hex)												
42	This sub-function shows the arrow display direction up/down, and the transfer direction display of the car.												
	<table border="1"> <tr> <td>Bit 15 ... 14</td> <td>13</td> <td>12</td> <td>11 ... 10</td> <td>9</td> <td>8</td> </tr> <tr> <td>H0</td> <td>Moving down</td> <td>Moving up</td> <td>H0</td> <td>Down</td> <td>Up</td> </tr> </table> <ul style="list-style-type: none"> Bit 8 and 9 show the arrow display direction up/down. OFF (0): Do not display the arrow ON (1): Display the arrow Bit 12 and 13 show the transfer direction display of the car. OFF (0): Not moving ON (1): Moving 		Bit 15 ... 14	13	12	11 ... 10	9	8	H0	Moving down	Moving up	H0	Down
Bit 15 ... 14	13	12	11 ... 10	9	8								
H0	Moving down	Moving up	H0	Down	Up								
43	00	Used for instruction → all displays off											
	01	No load											
	02	Full load											
	03	Over load											
	04	Fire											
43	05	Fire brigade service											
	06	Help is coming											
	07	Special service											
	08	Load time											
	09	Occupied											
	0A	Out of order											
	0B	Close door											
	0C	Case of fire											
	0D	Hall call disable											
	0E	Travel to evacuation floor											
	0F	Travel to fire recall floor											
10 to FF	Reserved												
44	This sub-function shows the arrival indication of up/down.												
	<table border="1"> <tr> <td>Bit 15 ... 10</td> <td>9</td> <td>8</td> </tr> <tr> <td>H0</td> <td>Down</td> <td>Up</td> </tr> </table> <p>OFF (0): Not arrived ON (1): Arrived</p>		Bit 15 ... 10	9	8	H0	Down	Up					
Bit 15 ... 10	9	8											
H0	Down	Up											
45 to 46	00 to FF	Reserved											
47	00	Switch off speech synthesis on all output panels											
	01 to FE	Announce floor number 1 to 254											
	FF	Announce current floor number											
48 to 49	00 to FF	Reserved											
4A	00	Reserved											
	01	Hall call enable											
	02	Lift operational											
	03 to FF	Reserved											
4B to 7F	00 to FF	Reserved											
80 to FF	00 to FF	Manufacturer-specific											

3. Lift field [Low byte in BFM #3002 and #13002]

This value provides the lift number or the group of lifts, to which the output is assigned.

BFM #3002 BFM #13002 Low Byte	Description							
	Bit 7	Bit 6	Bit 5	Bit 4	Bit 3	Bit 2	Bit 1	Bit 0
BFM #3002 BFM #13002 Bit 0 to 7	Lift 8	Lift 7	Lift 6	Lift 5	Lift 4	Lift 3	Lift 2	Lift 1

1	Introduction
2	Specifications
3	Installation
4	Wiring
5	Introduction of Functions
6	Allocation of Buffer Memories
7	Interface and Device Profile (405 mode)
8	Lift Application Profile (417 Mode)
9	CAN Layer 2 Mode
10	Command Interface

4. Floor field [High byte in BFM #3002 and #13002]

BFM #3002 BFM #13002 High Byte Value (hex)	Description
00	Car panel
01 to FE	Floor number 1 to 254
FF	All floor panels

5. Door field [Low byte in BFM #3003 and #13003]

This value provides the door number to which the output is assigned. The structure of the field depends on the value of the basic function field. If the bits of the door field are set to 1, this shall indicate an assignment of the output to this door.

Basic Function Field	Door Field	Description
BFM #3001 BFM #13001 Low Byte Value (hex)	BFM #3003 BFM #13003 Low Byte Bit No.	
00 to 07 or 0E to FF	Bit 0	Door 1
	Bit 1	Door 2
	Bit 2	Door 3
	Bit 3	Door 4
	Bit 4 to 7	Bit 4 to 7 fixed to OFF (0).
08 to 0D	Bit 0	Source door 1
	Bit 1	Source door 2
	Bit 2	Source door 3
	Bit 3	Source door 4
	Bit 4	Destination door 1
	Bit 5	Destination door 2
	Bit 6	Destination door 3
Bit 7	Destination door 4	

6. Function data field [High byte in BFM #3003 and #13003]

The function data provides the input state of a virtual input.

BFM #3003 BFM #13003 (High Byte) Bit No.	Description	
Bit 8	Status	OFF (0): No data indicated (Does not apply for basic function H40) ON (1): Data indicated
Bit 9 to 11	Property	Bit 9 to 11 value (hex) H0: No action (default) H1: Output continuously H2: Output pulsed H3: Output flashing H4: Output coloured H5: Output with volume H6: Output with scroll rate H7: Reserved
Bit 12 to 14	Property parameter	Refer to table below
Bit 15	Predicate	OFF (0): Acknowledgement is not affirmed ON (1): Acknowledgement is affirmed

Value definition of the property parameter field (Bit 12 to 14)

Bit 12 to 14 value (hex)	Description						
	No action	Continuous	Pulsed	Flashing	Colour	Volume	Scroll rate
0	No action	Reserved	< 0.5 s	10 Hz	White	Minimum	Automatic
1			1 s	7.5 Hz	Yellow	Vary	1 line/s
2			1.5 s	5 Hz	Reserved	Vary	2 line/s
3			2 s	2 Hz	Green	Vary	3 line/s
4			3 s	1.5 Hz	Reserved	Vary	4 line/s
5			5 s	1 Hz	Red	Vary	5 line/s
6			10 s	0.5 Hz	Reserved	Vary	6 line/s
7			> 15 s	0.25 Hz	Blue	Maximum	7 line/s

8.4 Door Control Word/Door Status Word

When BFM #3050 to #3081 and #12050 to 12081 are read, the Door status word is read from BFM. When BFM #13050 to #13081 are read, the Door control word is read from BFM. And when BFM #3050 to #3081 and #13050 to #13081 are written to, the Door control word is written to BFM.

8.4.1 Door control word

The Door control word contains the door commands and other control data.

Bit	15 ... 12	11 ... 10	9 ... 8	7 ... 6	5 ... 4	3 ... 2	1 ... 0
	Command	Door velocity	Motion detector	Finger protector	Door lock	Battery power	H3

1. Battery power field [Bit 2, 3]

Bit 3	Bit 2	Description
OFF(0)	OFF(0)	Battery power supply disabled
OFF(0)	ON (1)	Battery power supply enabled
ON (1)	OFF(0)	Reserved
ON (1)	ON (1)	Do not care / take no action

2. Door lock field [Bit 4, 5]

Bit 5	Bit 4	Description
OFF(0)	OFF(0)	Enable door lock
OFF(0)	ON (1)	Disable door lock
ON (1)	OFF(0)	Reserved
ON (1)	ON (1)	Do not care / take no action

3. Finger protector field [Bit 6, 7]

Bit 7	Bit 6	Description
OFF(0)	OFF(0)	Enable finger protector
OFF(0)	ON (1)	Disable finger protector
ON (1)	OFF(0)	Reserved
ON (1)	ON (1)	Do not care / take no action

4. Motion detector field [Bit 8, 9]

Bit 9	Bit 8	Description
OFF(0)	OFF(0)	Enable motion detector
OFF(0)	ON (1)	Disable motion detector
ON (1)	OFF(0)	Reserved
ON (1)	ON (1)	Do not care / take no action

5. Door velocity field [Bit 10, 11]

Bit 11	Bit 10	Description
OFF(0)	OFF(0)	Move door with standard speed
OFF(0)	ON (1)	Move door with reduced speed
ON (1)	OFF(0)	Reserved
ON (1)	ON (1)	Do not care / take no action

1

Introduction

2

Specifications

3

Installation

4

Wiring

5

Introduction of Functions

6

Allocation of Buffer Memories

7

Interface and Device Profile (405 mode)

8

Lift Application Profile (417 Mode)

9

CAN Layer 2 Mode

10

Command Interface

6. Command field [Bit 12 to 15]

Bit 12 to 15 Value (hex)	Description
0	Close door without limit force (Not allowed for EN-81 compliant lifts)
1	Close door with limit force
2	Nudging (Forced closing of car door with reduced speed without reversal devices due to the blocked door for too long time)
3	Open door without limit force (Not allowed for EN-81 compliant lifts)
4	Open door with limit force
5	Reserved
6	Reserved
7	Stop door without torque
8	Stop door with torque
9 to C	Reserved
D	Tech-in drive
E	Reset door
F	Do not care / take no action

8.4.2 Door status word

This Object contains the car door status and other status information.

Bit	15 ... 12	11 ... 10	9 ... 8	7 ... 6	5 ... 4	3 ... 2	1 ... 0
	Status	Force limit	Motion detector	Finger protector	Door lock	Battery power	Safety contact

1. Safety contact field [Bit 0, 1]

Bit 1	Bit 0	Description
OFF(0)	OFF(0)	Contact not closed
OFF(0)	ON (1)	Contact closed
ON (1)	OFF(0)	Error indicator
ON (1)	ON (1)	Not available or not installed

2. Battery power field [Bit 2, 3]

Bit 3	Bit 2	Description
OFF(0)	OFF(0)	No battery power used
OFF(0)	ON (1)	Battery power used
ON (1)	OFF(0)	Error indicator
ON (1)	ON (1)	Not available or not installed

3. Door lock field [Bit 4, 5]

Bit 5	Bit 4	Description
OFF(0)	OFF(0)	Door not locked
OFF(0)	ON (1)	Door locked
ON (1)	OFF(0)	Error indicator
ON (1)	ON (1)	Not available or not installed

4. Finger protector field [Bit 6, 7]

Bit 7	Bit 6	Description
OFF(0)	OFF(0)	No finger detected
OFF(0)	ON (1)	Finger detected
ON (1)	OFF(0)	Error indicator
ON (1)	ON (1)	Not available or not installed

5. Motion detector field [Bit 8, 9]

Bit 9	Bit 8	Description
OFF(0)	OFF(0)	Motion not detected
OFF(0)	ON (1)	Motion detected
ON (1)	OFF(0)	Error indicator
ON (1)	ON (1)	Not available or not installed

6. Force limit field [Bit 10, 11]

Bit 11	Bit 10	Description
OFF(0)	OFF(0)	Force limit not reached
OFF(0)	ON (1)	Force limit reached
ON (1)	OFF(0)	Error indicator
ON (1)	ON (1)	Not available or not installed

7. Status field [Bit 12 to 15]

Bit 12 to 15 Value (hex)	Description
0	Door closed with torque
1	Door closed without torque
2	Door is closing
3	Door opened with torque
4	Door opened without torque
5	Door is opening
6	Door is re-opening

Bit 12 to 15 Value (hex)	Description
7	Door stopped with torque (not in an end position)
8	Door stopped without torque (not in an end position)
9 to C	Reserved
D	Tech-in drive
E	Error indicator
F	Not available or not installed

Note

If the door is in an open or closed end position, this shall have higher priority than stopped status.

8.5 Door Position

These BFM's store the Door position information of each Lift number. The value is in units of mm. H0 value shows Closed and HFFFF shows "not available or not requested".

8.6 Light Barrier Status

These BFM's contain the status information of the VD light barrier unit for up to four doors.

Bit No.	Description																				
Bit 0 to 5	Bit 0 to 5 fixed to ON (1).																				
Bit 6 and 7	<table border="1"> <thead> <tr> <th>Status</th> <th>Bit 7</th> <th>Bit 6</th> <th>Description</th> </tr> </thead> <tbody> <tr> <td></td> <td>OFF (0)</td> <td>OFF (0)</td> <td>No subject detected</td> </tr> <tr> <td></td> <td>OFF (0)</td> <td>ON (1)</td> <td>Subject detected</td> </tr> <tr> <td></td> <td>ON (1)</td> <td>OFF (0)</td> <td>Error indicator</td> </tr> <tr> <td></td> <td>ON (1)</td> <td>ON (1)</td> <td>Not available or not installed</td> </tr> </tbody> </table>	Status	Bit 7	Bit 6	Description		OFF (0)	OFF (0)	No subject detected		OFF (0)	ON (1)	Subject detected		ON (1)	OFF (0)	Error indicator		ON (1)	ON (1)	Not available or not installed
Status	Bit 7	Bit 6	Description																		
	OFF (0)	OFF (0)	No subject detected																		
	OFF (0)	ON (1)	Subject detected																		
	ON (1)	OFF (0)	Error indicator																		
	ON (1)	ON (1)	Not available or not installed																		
Bit 8 to 15	Bit 8 to 15 fixed to OFF (0).																				

8.7 Position Value

These BFM's store the Position value (32 bit data) from the car position units of each Lift number. This value needs to be handled by 32 bit instructions.

The values shall be equivalent to object H6004 in the CiA® 406 specification.

8.8 Speed Value Car

These BFMs store the Speed value from the car position units of each Lift number. The measuring step is defined in object H6384 of the car position unit.

8.9 Acceleration Value Car

These BFMs store the acceleration value from the car position units of each Lift number. The measuring step is defined in Object H6384 of the car position unit.

8.10 Control Word/Status Word

When BFM #3428 to #3435 and #12428 to 12435 are read, the Status word is read from BFMs. When BFM #13428 to #13435 are read, the Control word is read from BFMs. And when BFM #3428 to #3435 and #13428 to #13435 are written to, the Control word is written to BFMs.

8.10.1 Control word

The Car drive Control word is based on object H6040 in the CiA® 402-2 V3.0 specifications.

Note

- Bits 4, 5, 6, and 9 of the control word are operation mode specific.
- The halt function (bit 8) behaviour is operation mode specific.
If the bit is ON (1), the commanded motion shall be interrupted; the Power drive system shall behave as defined in the halt option code.
After releasing the halt function, the commanded motion shall be continued if possible.

Bit	15	14	13 ... 11	10	9	8	7	6 ... 4	3	2	1	0
	insp	rcl	ms	H0	oms	h	fr	oms	eo	qs	ev	so

Bit	Item	Description
Bit 0	so	Switch on
Bit 1	ev	Enable voltage
Bit 2	qs	Quick stop
Bit 3	eo	Enable operation
Bit 4 to 6	oms	Operation mode specific
Bit 7	fr	Fault reset
Bit 8	h	Halt
Bit 9	oms	Operation mode specific
Bit 10	-	Bit 10 fixed to OFF (0).
Bit 11 to 13	ms	Manufacturer-specific
1Bit 4	rcl	OFF (0): Emergency recall operation mode inactive ON (1): Emergency recall operation mode active
Bit 15	insp	OFF (0): Car top inspection operation mode inactive ON (1): Car top inspection mode active

Status transition

Number: Transition No.

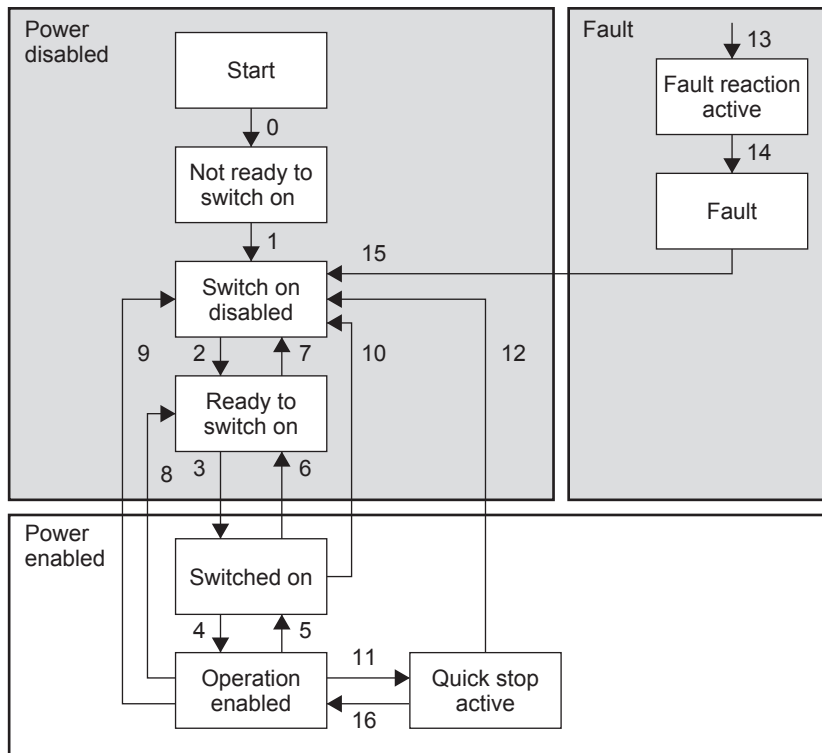

Command	Bits of the control word					Transition No.
	Bit 7	Bit 3	Bit 2	Bit 1	Bit 0	
Shutdown	0	X	1	1	0	2, 6, 8
Switch on	0	0	1	1	1	3
Switch on + enable operation	0	1	1	1	1	3 + 4 (Note)
Disable voltage	0	X	X	0	X	7, 9, 10, 12
Quick stop	0	X	0	1	X	7, 10, 11
Disable operation	0	0	1	1	1	5
Enable operation	0	1	1	1	1	4, 16
Fault reset	0 → 1	X	X	X	X	15

Note

- At the following Transition numbers occur a automatic status transition: 0, 1, 13, 14
- Automatic transition to enable operation state after executing SWITCHED ON state functionality.

1	Introduction
2	Specifications
3	Installation
4	Wiring
5	Introduction of Functions
6	Allocation of Buffer Memories
7	Interface and Device Profile (405 mode)
8	Lift Application Profile (417 Mode)
9	CAN Layer 2 Mode
10	Command Interface

8.10.2 Status word

This Car drive Status word is equivalent to object H6041 in the CiA® 402-2 V3.0 specification.

Bit	15 ... 14	13 ... 12	11	10	9	8	7	6	5	4	3	2	1	0
	ms	oms	ila	tr	rm	ms	w	sod	qs	ve	f	oe	so	rtso

Bit No.	Item	Description / set range
Bit 0	rtso	Ready to switch on
Bit 1	so	Switched on
Bit 2	oe	Operation enabled
Bit 3	f	Fault
Bit 4	ve	Voltage enabled ON when high voltage is applied to the Power drive system.
Bit 5	qs	Quick stop OFF When the Power drive system is reacting on a quick stop request.
Bit 6	sod	Switch on disabled
Bit 7	w	Warning ON when being a warning condition. The status of the Power drive system Finite state automaton will not be changed, as warning is not an error or fault.
Bit 8	ms	Manufacturer-specific
Bit 9	rm	Remote When this bit is ON, the control word is processed. If it is off (local), the control word is not processed.
Bit 10	tr	Target reached <ul style="list-style-type: none"> ON when the Power drive system has reached the set-point. The set-point is operation mode specific. This Bit is set to on, if the operation mode has been changed. ON if the quick stop option code is 5, 6, 7 or 8, when the quick stop operation is finished and the Power drive system is halted. ON when halt occurred and the Power drive system is halted.
Bit 11	ila	Internal limit active ON when an internal limit is active.
Bit 12 to 13	oms	Operation mode specific
Bit 14 to 15	ms	Manufacturer-specific

Status Word	Power Drive System Finite State Automaton State
xxxx xxxx x0xx 0000 b	Not ready to switch on
xxxx xxxx x1xx 0000 b	Switch on disabled
xxxx xxxx x01x 0001 b	Ready to switch on
xxxx xxxx x01x 0011 b	Switched on
xxxx xxxx x01x 0111 b	Operation enabled
xxxx xxxx x00x 0111 b	Quick stop active
xxxx xxxx x0xx 1111 b	Fault reaction active
xxxx xxxx x0xx 1000 b	Fault

8.11 Modes of operation/Modes of operation display

When BFM #3436 to #3443 and #12436 to 12443 are read, the Modes of operation display is read from BFMs. When BFM #13436 to #13443 are read, the Modes of operation is read from BFMs. And when BFM #3436 to #3443 and #13436 to #13443 are written to, the Modes of operation is written to BFMs.

8.11.1 Modes of operation

This Car drive mode of operation is equivalent to object H6060 in the CiA® 402-2 V3.0 specifications. Bits 8 to 15 are fixed to OFF (0). Even if set to ON (1), these bits will remain OFF (0).

Low byte Value (Dec)	Description
-128 to -1	Manufacturer-specific operation modes
0	No mode change or no mode assigned
+1	Profile position mode
+2	Velocity mode
+3	Profile velocity mode
+4	Torque profile mode
+5	Reserved
+6	Homing mode
+7	Interpolated position mode
+8	Cyclic sync position mode
+9	Cyclic sync velocity mode
+10	Cyclic sync torque mode
+11 to +127	Reserved

8.11.2 Modes of operation display

This Car drive mode of operation display is equivalent to object H6061 in the CiA® 402-2 V3.0 specifications. This object provides the actual operation mode. Bits 8 to 15 are fixed to OFF (0) in these BFMs. The value description can be shown in the Modes of operation.

→ Refer to Subsection 8.11.1

8.12 Control Effort

This Car drive control effort shall contain the breaking point or breaking distance depending on the target position given respectively as absolute value or relative value.

The value (32 bit data) shall be given in user-defined position units. It is necessary to read position value by 32 bit instructions.

8.13 Position Actual Value/Target Position

When BFM #3460 to #3475 and #12460 to 12475 are read, the Position actual value is read from BFMs. When BFM #13460 to #13475 are read, the Target position is read from BFMs. And when BFM #3460 to #3475 and #13460 to #13475 are written to, the Target position is written to BFMs.

8.13.1 Position actual value

This Car drive position actual value is equivalent to object H6064 in the CiA® 402-2 V3.0 specification and shall contain the position of the drive shaft. This information is used to calculate the slippage of the position unit. The value (32 bit data) shall be given in user-defined position units. This value needs to be handled by 32 bit instructions.

1

Introduction

2

Specifications

3

Installation

4

Wiring

5

Introduction of Functions

6

Allocation of Buffer Memories

7

Interface and Device Profile (405 mode)

8

Lift Application Profile (417 Mode)

9

CAN Layer 2 Mode

10

Command Interface

8.13.2 Target position

This Car drive target position is equivalent to object H607A in the CiA® 402-2 V3.0 specifications. This Target position contains the commanded position that the drive should move to in position profile mode using the current settings of the motion control parameters such as velocity, acceleration, deceleration, motion profile type etc. The value (32 bit data) shall be interpreted as absolute or relative depending on the 'abs/rel' flag in the control word. This value needs to be handled by 32 bit instructions. It shall be given in user-defined position units and shall be converted to position increments.

8.14 Profile Velocity

This Car drive profile Velocity is equivalent to object H6081 in the CiA® 402-2 V3.0 specifications. The value (32 bit data) is in units of mm/s.

This value needs to be handled by 32 bit instructions.

8.15 Velocity Actual Value/Target Velocity

When BFM #3492 to #3507 and #12492 to 12507 are read, the Velocity actual value is read from BFM. When BFM #13492 to #13507 are read, the Target velocity is read from BFM. And when BFM #3492 to #3507 and #13492 to #13507 are written to, the Target velocity is written to BFM.

8.15.1 Target velocity

This Car drive target velocity is equivalent to object H60FF in the CiA® 402-2 V3.0 specifications. The value (32 bit data) is in units of mm/s.

This value needs to be handled by 32 bit instructions.

8.15.2 Velocity actual value

This Car drive velocity actual value is equivalent to object H606C in the CiA® 402-2 V3.0 specification. The value (32 bit data) is in units of mm/s.

This value needs to be handled by 32 bit instructions.

8.16 Load Value

These BFM contain the Car drive load value and its related SI unit. The load value is the absolute value of the load (payload). It is in units of the configured SI unit. The load value of HFFFF shall be an error value that is applied if the sensor is in error state or does not have an actual value.

SI unit structure

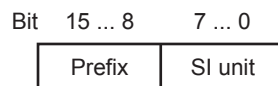

The default SI unit is kg. The SI unit and prefix field values shall use the coding as defined in the CiA® 303-2 specifications.

8.17 Load Signalling

These BFM contain Car drive load signal information. It is used to signal measuring values of the load measuring system. Load signal contains different kinds of load signal. If one of the load bits (for zero load, norm load, full load, and overload) is set to ON (1), the related condition is true. If the bit is set to 0, the related condition is not true. Load signal interrupt contains the information about whether the related load bit shall be processed (1) or not (0).

Bits 8 to 15 are fixed to OFF (0) in these BFM.

Load signal structure

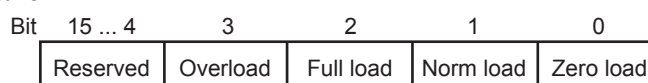

9. CAN Layer 2 Mode

This chapter describes the data transfer locations and setting, etc. of the 11 bit/29 bit CAN-ID Layer 2 mode. In the 11 bit/29 bit CAN-ID Layer 2 mode, the FX3U-CAN can send/receive up to 42 pre-defined messages. Moreover, Layer 2 messages can be sent via CIF.

Difference between 11 bit/29 bit CAN-ID Layer 2 Modes

The bit numbers of the CAN-ID used in 11 bit/29 bit CAN-ID Layer 2 modes differ between 11 bit and 29 bit.

Note

- To ensure that the FX3U-CAN module can handle the CAN Layer 2 message in a consistent way, it is necessary to set BFM #20 bit 0 to ON before reading the received message (FROM) and after writing the transmitted message (TO) to the module.
→ For BFM #20 bit 0, refer to Section 6.4
- To activate the 11 bit/29 bit CAN-ID Layer 2 mode, write into BFM #21 the value K11 or K29, set BFM #22 to K1 to store the BFM configuration and reset the module.
→ For module reset, refer to Section 6.8
- BFMs (#0 to #19, #27, #50 to #59, #750 to #859, #900 to #963, and #3000 to #3539), which are active in the CANopen® 405 mode or CANopen® 417 mode, are not active and not accessible in CAN Layer 2 Mode.

9.1 Receive/Transmit Process Data

The data transfer locations of the 11 bit/29 bit CAN-ID Layer 2 mode are as follows.

Note

The following settings of each message have to be defined in Layer 2 configuration mode, before shifting to the Layer 2 online mode.

- The CAN-ID LW, CAN-ID HW and transmitting data byte number (in RTR/new/DLC) in the following BFM
- Layer 2 message configuration in BFM #1100 to #1276
Sets the parameters (transmitting/receiving message, etc.) for each message.
→ For Layer 2 message configuration in BFM #1100 to #1267, refer to Section 9.3

BFM No.	Name	Description		Initial value	Read/Write	Stored to Flash ROM
		High Byte	Low Byte			
BFM #0 to #19	Reserved			-	-	-
BFM #100	CAN-ID 1 LW	11/29 bit CAN-Identifier low word		HFFFF	R/W	✓ ¹
BFM #101	CAN-ID 1 HW	29 bit CAN-Identifier high word		HFFFF	R/W	✓ ¹
BFM #102	RTR / new / DLC	High Byte: Remote Transmission Request Low Byte: Data length count		H0	R/W	✓ ¹
BFM #103	Data bytes	2nd data byte	1st data byte	H0	R/W ²	-
BFM #104		4th data byte	3rd data byte	H0	R/W ²	-
BFM #105		6th data byte	5th data byte	H0	R/W ²	-
BFM #106		8th data byte	7th data byte	H0	R/W ²	-
⋮	⋮	⋮		⋮	⋮	⋮

- 1 Introduction
- 2 Specifications
- 3 Installation
- 4 Wiring
- 5 Introduction of Functions
- 6 Allocation of Buffer Memories
- 7 Interface and Device Profile (405 mode)
- 8 Lift Application Profile (417 Mode)
- 9 CAN Layer 2 Mode
- 10 Command Interface

BFM No.	Name	Description		Initial value	Read/Write	Stored to Flash ROM
		High Byte	Low Byte			
BFM #387	CAN-ID 42 LW	11/29 bit CAN-Identifier low word		HFFFF	R/W	✓*1
BFM #388	CAN-ID 42 HW	29 bit CAN-Identifier high word		HFFFF	R/W	✓*1
BFM #389	RTR / new / DLC	High Byte: Remote Transmission Request Low Byte: Data length count		H0	R/W	✓*1
BFM #390	Data bytes	2nd data byte	1st data byte	H0	R/W*2	-
BFM #391		4th data byte	3rd data byte	H0	R/W*2	-
BFM #392		6th data byte	5th data byte	H0	R/W*2	-
BFM #393		8th data byte	7th data byte	H0	R/W*2	-
BFM #394 to #399	Reserved			-	-	-

*1. These BFM will be stored into the Flash ROM when the save command is executed.

→ For the save command, refer to Section 6.6

*2. Receive messages are read only, transmit messages can be read and written.

1. When transmitting messages

The CAN-ID, RTR/new/DLC and data bytes of each message are as follows.

1) CAN-ID

The destination of the message is specified by CAN-ID. CAN-ID is as follows, corresponding to the function mode to be used.

→ For function mode, refer to Section 6.5

Function Mode	Description
11 bit CAN-ID Layer 2 Mode	Store CAN-ID in the 11 bits, bit 0 to 10, in the CAN-ID n*2 LW. In this function mode, CAN-ID n*2 HW are ignored.
29 bit CAN-ID Layer 2 Mode	Store CAN-ID in the 29 bits, bit 0 to 28, in the CAN-ID n*2 LW and CAN-ID n*2 HW. Handle CAN-ID n*2 LW and CAN-ID n*2 HW by 32 bit instructions.

*2. The "n" corresponds to the Layer 2 message number.

2) RTR/new/DLC

RTR/new/DLC is set as follows.

High Byte/Low Byte	Description
High byte	Bit 12 ON: Strict DLC check for RTR Bit 15 OFF: Send data frame Bit 15 ON: Send RTR frame*3
Low byte	Number of data bytes to transmit (K0 to K8)*3

*3. Bit 15 defines whether the message is transmitted as a data frame (Bit 15 = OFF) or a Remote Transmit Request frame (Bit 15 = ON). Bit 12 = ON enables a strict DLC check for received RTR frames. If Bit 12 is OFF, only the CAN-ID of an inbound RTR frame is checked for a match with a user message; if the bit is ON, the CAN-ID and the DLC of the RTR frame must match the user message to cause a response or BFM #1270 to #1272 flag to be set.

Bit 15 and Bit 12 cannot be set ON at the same time.

Bit 15 can be set ON if the parameter B is set to H5FFF.

Bit 12 can be set ON if the parameter B is set to H6FFF or H7FFF.

→ For parameter B, refer to Section 9.3

3) Data bytes

Store the data to transmit. The data length of the transmit data is set by DLC.

2. When receiving messages

The CAN-ID, RTR/new/DLC and data bytes of each message are as follows.

Note

In case more than one ID can pass the filter set in BFM #1100 to #1267, the received CAN-ID might change and will always display the CAN-ID, DLC and data of the latest received message.

→ For Layer 2 message configuration in BFM #1100 to #1267, refer to Section 9.3

1) CAN-ID

The source CAN-ID of the received Layer 2 message is stored. CAN-ID is as follows corresponding to the function mode to be used.

→ For the function mode, refer to Section 6.5

Function Mode	Description
11 bit CAN-ID Layer 2 Mode	CAN-ID is stored in the 11 bits, bit 0 to 10, in the CAN-ID n ^{*1} LW. In this function mode, CAN-ID n ^{*1} HW does not used.
29 bit CAN-ID Layer 2 Mode	CAN-ID is stored in the 29 bits, bit 0 to 28, in the CAN-ID n ^{*1} LW and CAN-ID n ^{*1} HW. Handle CAN-ID n ^{*1} LW and CAN-ID n ^{*1} HW by 32 bit instructions.

*1. The "n" corresponds to the Layer 2 message number.

2) RTR/new/DLC

High Byte/Low Byte	Description
High byte	H00: New data is not received. Bit 8: ON when new data is received. Bit 9: ON when new frame is received. Bit 10: ON when overflowing.*2
Low byte	Data length count (DLC) of the received CAN frame.

*2. If bit 8 of the RTR/new/DLC is ON, a new message including new data has been received and stored. If bit 9 is ON but bit 8 is OFF, the same message (same ID, DLC and data) has been received. If bit 10 is ON, at least one more message has been stored in this message buffer while bit 8 was ON which caused an overflow condition.

Flags RTR / new / DLC	Receive messages only				
	New frame no new data	New frame new data	New frame no new data overflow occur	New frame new data overflow occur	No data received
New data (bit 8)	OFF	ON	OFF	ON	- (Do not care)
New frame (bit 9)	ON	ON	ON	ON	OFF
Overflow (bit 10)	OFF	OFF	ON	ON	- (Do not care)

3) Data bytes

The data received of length specified by DLC is stored.

In case the received DLC is less than 8, unused data bytes are set to H00.

1

Introduction

2

Specifications

3

Installation

4

Wiring

5

Introduction of
Functions

6

Allocation of
Buffer Memories

7

Interface and
Device Profile
(405 mode)

8

Lift Application
Profile
(417 Mode)

9

CAN Layer 2
Mode

10

Command
Interface

9.2 Layer 2 Message Specific Error Code List

This List contains an error message for each Layer 2 message.

BFM No.	Detailed Error Code for Each Layer 2 Message
BFM #401	Message 1 error code
BFM #402	Message 2 error code
⋮	⋮
BFM #442	Message 42 error code

Error code in Layer 2 message

Error Code	Error Code Description
H0000	No error
H2000	Receive buffer overflowed

9.3 Pre-defined Layer 2 Message Configuration

This section describes the Pre-defined Layer 2 message configuration.

The parameters of Layer 2 message number are used to define if the corresponding Layer 2 message number in BFM #100 to #393 is a transmit or receive message.

Note

- The Pre-defined Layer 2 message configuration can be set in Layer 2 configuration mode (BFM #25 bit 4 is OFF).
→ **For the communication status (BFM #25), refer to Section 6.8**
- If an invalid value is written to one of BFM #1100 to #1267, then BFM #29 bit 6 is set, and the BFM address is displayed in BFM #39.
- If the Layer 2 message number is not used, parameter A and B should be set to HFFFF.

BFM No.	Name	Description	Initial value	Read/Write
BFM #1100	Layer 2 message 1 parameter A	Layer 2 message 1 parameter	HFFFF	R/W
BFM #1101	Layer 2 message 1 parameter B		HFFFF	R/W
BFM #1102	Layer 2 message 1 parameter C		H0000	R/W
BFM #1103	Layer 2 message 1 parameter D		H0000	R/W
BFM #1104	Layer 2 message 2 parameter A	Layer 2 message 2 parameter	HFFFF	R/W
BFM #1105	Layer 2 message 2 parameter B		HFFFF	R/W
BFM #1106	Layer 2 message 2 parameter C		H0000	R/W
BFM #1107	Layer 2 message 2 parameter D		H0000	R/W
⋮	⋮	⋮	⋮	⋮
BFM #1260	Layer 2 message 41 parameter A	Layer 2 message 41 parameter	HFFFF	R/W
BFM #1261	Layer 2 message 41 parameter B		HFFFF	R/W
BFM #1262	Layer 2 message 41 parameter C		H0000	R/W
BFM #1263	Layer 2 message 41 parameter D		H0000	R/W
BFM #1264	Layer 2 message 42 parameter A	Layer 2 message 42 parameter	HFFFF	R/W
BFM #1265	Layer 2 message 42 parameter B		HFFFF	R/W
BFM #1266	Layer 2 message 42 parameter C		H0000	R/W
BFM #1267	Layer 2 message 42 parameter D		H0000	R/W

9.3.1 Pre-defined Layer 2 transmit messages

This subsection describes parameters A to D for the transmit message.

Parameter	Description	Initial value
Layer 2 message number parameter A	Constant HFFFF	HFFFF
Layer 2 message number parameter B	H7FFF (auto RTR response) H6FFF (manual RTR response) H5FFF (disable RTR handling) HFFFF (message disabled)	HFFFF
Layer 2 message number parameter C	Transmission type	H0000
Layer 2 message number parameter D	Cycle time in [10 ms]	H0000

1. Parameter A and B for each Layer 2 message

A message buffer in BFM #100 to #393 is assigned to a Layer 2 transmit message by writing HFFFF in parameter A, and writing H7FFF, H6FFF or H5FFF in parameter B.

When Layer 2 message number is not used, set HFFFF to both parameter A and B.

Note

The Layer 2 implementation of the FX3U-CAN can handle up to 28 transmit slots with RTR handling (parameter B = H7FFF or H6FFF). If the configuration violates this rule, the first 28 transmit message configurations remain as they are, and RTR handling is disabled for any further transmit messages as parameter B is forced to H5FFF.

→ For the RTR message reception list, refer to Section 9.4

- When using the auto RTR response
Set H7FFF to parameter B for the Layer 2 message.
The FX3U-CAN automatically responds to Remote Transmit Requests (RTRs) if the 11/29 bit CAN-ID (i.e. set in BFM #100) matches the ID in the RTR message.
The RTR message is not stored to the RTR flag list.
- When using the manual RTR response
Set H6FFF to parameter B for the Layer 2 message.
The FX3U-CAN will not automatically respond to Remote Transmit Requests, but the RTR ID will be added to the RTR flag list.
- When using the disable RTR handling
Set H5FFF to parameter B for the Layer 2 message.
The FX3U-CAN will discard any incoming RTR telegrams matching the CAN-ID of this Layer 2 message.

1

Introduction

2

Specifications

3

Installation

4

Wiring

5

Introduction of Functions

6

Allocation of Buffer Memories

7

Interface and Device Profile (405 mode)

8

Lift Application Profile (417 Mode)

9

CAN Layer 2 Mode

10

Command Interface

2. Parameter C "transmission type" for each Layer 2 message

The transmission type defines the transmit/receive message and transmission trigger event of the message as follows.

Transmission Type value	Message Type	Transmission Trigger Event
K0	Transmit message	When BFM #20 bit 0 is set to ON, the Layer 2 message is always transmitted.
K1		When BFM #20 bit 0 is set to ON, the Layer 2 message is transmitted. However, if data has not been changed, it is not transmitted.
K2		The Layer 2 message transmits with following condition. <ul style="list-style-type: none"> • With a cycle time set by parameter D • BFM #20 bit 0 set to ON
K3		The Layer 2 message transmits with following condition. However, if data has not been changed, it is not transmitted. <ul style="list-style-type: none"> • With a cycle time set by parameter D • BFM #20 bit 0 set to ON
K4		The Layer 2 message transmits with following condition. <ul style="list-style-type: none"> • Request via RTR frames Request via RTR frames works for maximum 28 transmit messages. • Message transmit trigger flags The Layer 2 message transmits when the corresponding message transmit trigger flag in BFM #1280 to #1282 is set to ON. <p style="text-align: right;">→ For the message transmit trigger flag, refer to Section 9.5</p>

3. Parameter D "cycle time" for each Layer 2 message

This parameter is used when the transmission type (event) is set to K2 or K3.

The cycle time is in units of ms

Note

- The cycle time should be set in consideration of the PLC scan cycle and communications response time, etc.
- If cycle time is set to K0, cycle time operates as 1 ms.

9.3.2 Pre-defined Layer 2 receive messages

This subsection describes parameters A to D for the receive message.

Parameter	Description	Initial Value
Layer 2 message number parameter A	Reception CAN-ID low word	HFFFF
Layer 2 message number parameter B	Reception CAN-ID high word	HFFFF
Layer 2 message number parameter C	Reception ID filter bit mask low word	H0000
Layer 2 message number parameter D	Reception ID filter bit mask high word	H0000

1. Parameter A and B for each Layer 2 message

Set the source CAN ID of the received message to parameter A and B. CAN-ID is as follows, corresponding to the function mode to be used.

When Layer 2 message number is not used, set HFFFF to both parameter A and B.

→ For function mode, refer to Section 6.5

Function Mode	Description
11 bit CAN-ID Layer 2 Mode	Store CAN-ID in the 11 bits, bit 0 to 10, in the parameters A and B by 32 bit instructions.
29 bit CAN-ID Layer 2 Mode	Store CAN-ID in the 29 bits, bit 0 to 28, in the parameters A and B by 32 bit instructions.

2. Parameter C and D for each Layer 2 message

Set the filter for the ID set in parameter A and B. If the filter is set to H00000000, incoming messages are checked for an exact match with the ID set in parameter A and B. Any bit set in the filter will be omitted when comparing received IDs with the ID set in parameter A and B.

Example 1:

Layer 2 message 1 parameter A/B = H00000181

Layer 2 message 1 parameter C/D = H00000000

BFM #100 to #106 store received messages with the CAN-ID H181 only. Relation between received CAN message, BFM #20 bit 0 and "RTR/new/DLC" high byte is shown below.

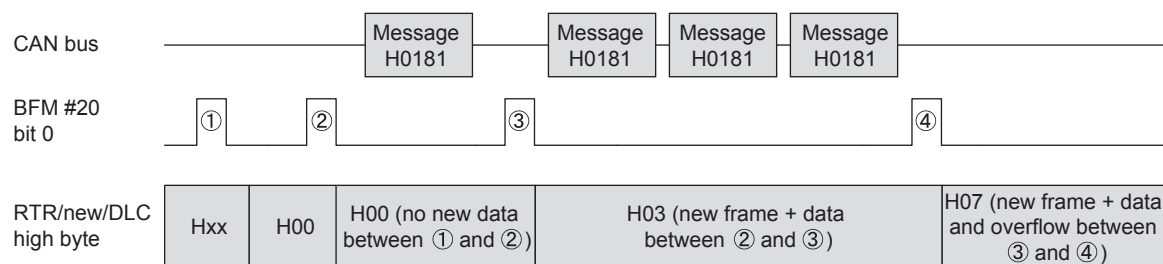

The flags "RTR/new/DLC" are cleared by PLC program after ①. They remain H00 after ②, because there was no message stored between ① and ②. The first received CAN message that matches parameter A/B and C/D is stored into the internal buffers, and as this is the only message between ② and ③, the high byte value is set to H03. The high byte value H07 after ④ shows that the buffer was overwritten at least once (in this example two times) since ③. The data bytes in the BFM are the data received with the last message.

Note

In this example, it is expected that the PLC program resets the "RTR/new/DLC" flags after reading the data at ①, ②, ③ and ④.

Example 2:

Layer 2 message 2 parameter A/B = H00000180

Layer 2 message 2 parameter C/D = H00000006

BFM #107 to #113 stores received messages with CAN-IDs H180, H182, H184 and H186 because ID bits 1 and 2 are not evaluated. Relation between received CAN message, BFM #20 bit 0 and "RTR/new/DLC" high byte is shown below.

Note

Please remember that in this case all four messages are stored in the same location! If more than one of the messages with ID H180, H182, H184 or H186 is received between two write operations BFM #20 = K1, only the last received CAN-ID, DLC, and data is available in BFM #107 to #113.

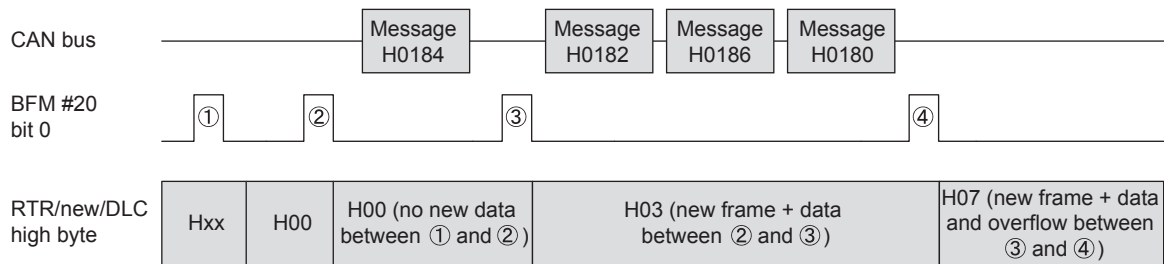

Behaviour until ④ is similar to that described in example 1.

Same as in the first example, the high byte value H07 after ④ shows that the buffer was overwritten at least once, since ③ and the data bytes in the BFM are also the data received with the last message.

But this time, it is required to check the 11 bit CAN-ID in the corresponding Layer 2 message (BFM #100 to #399) to determine which message ID was received. In this case the last message is H0180, and the data of this message is stored to the data BFM. The data of messages H0182 and H0186 are lost.

Note

In this example, it is expected that the PLC program resets the "RTR/new/DLC" flags after reading the data at ①, ②, ③ and ④.

9.4 Layer 2 RTR Flags

If the FX3U-CAN is set to Layer 2 communication mode, an incoming RTR message is indicated in the BFM if the following conditions are satisfied:

- Matching the "CAN-ID n*1" of one of the Layer 2 messages
- The Layer 2 message "n*1" is configured as a transmit Layer 2 message
- The Layer 2 message "n*1" is set to "no auto RTR response" (H6FFF)
 - *1. Where "n" is one of the Layer 2 messages 1 to 42.

The bits in the "RTR message reception list" are updated independently from BFM #20 bit 0. A bit is set if a valid RTR message has been received. The bit can be evaluated by PLC program and required changes to the response message data can be made (BFM #20 bit 0 must be set in order to refresh the internal data buffer and trigger the transmission). The flag is automatically reset when a message is transmitted from the Layer 2 message.

RTR message reception list

BFM No.	Bit No.	Description	Read/Write
BFM #1270	Bit 0	RTR message for Layer 2 message 1 received	R
	⋮	⋮	R
	Bit 15	RTR message for Layer 2 message 16 received	R
BFM #1271	Bit 0	RTR message for Layer 2 message 17 received	R
	⋮	⋮	R
	Bit 15	RTR message for Layer 2 message 32 received	R
BFM #1272	Bit 0	RTR message for Layer 2 message 33 received	R
	⋮	⋮	R
	Bit 9	RTR message for Layer 2 message 42 received	R
	Bit 10	Unused	R
	⋮		
Bit 15			

1	Introduction
2	Specifications
3	Installation
4	Wiring
5	Introduction of Functions
6	Allocation of Buffer Memories
7	Interface and Device Profile (405 mode)
8	Lift Application Profile (417 Mode)
9	CAN Layer 2 Mode
10	Command Interface

9.5 Message Transmit Trigger Flags

The transmission of a message in Layer 2 mode can be triggered via the following flags. Transmit requests on receive Layer 2 messages are discarded. When a bit is set to ON, the corresponding transmit message will be sent as soon as a transmit buffer is available. The flags are reset automatically as soon as the message is written into the transmit buffer.

BFM No.	Bit No.	Transmit request Layer 2 message	Remarks
BFM #1280	Bit 0	Layer 2 message 1	R/W
	⋮	⋮	R/W
	Bit 15	Layer 2 message 16	R/W
BFM #1281	Bit 0	Layer 2 message 17	R/W
	⋮	⋮	R/W
	Bit 15	Layer 2 message 32	R/W
BFM #1282	Bit 0	Layer 2 message 33	R/W
	⋮	⋮	R/W
	Bit 9	Layer 2 message 42	R/W
	Bit 10 to 15	Reserved	R/W

9.6 PLC RUN>STOP Messages

FX3U-CAN can transmit the message according to its state, if the PLC is in one of the following two states. Up to four transmit messages can each be registered.

- If PLC state had changed to STOP from RUN, or FROM/TO Watchdog in FX3U-CAN has been timed-out. In this case, the message registered into RUN>STOP messages 1 to 4 are transmitted.

Warning

Depending on PLC Type and baud rate and bus load, FX3U-CAN may be unable to send the message. In such a case, additional H/W and/or S/W should be considered for safe system behavior.

If possible use only one "RUN>STOP message" which will increase the possibility that the information is transmitted in the event "RUN>STOP" occurs.

If more than one message is defined, messages are transmitted in order of priority "message 1" to "message 4".

Note

- The time differs depending on the number of I/Os and on the number and types of extension blocks.

BFM No.	Function	Description		Layer 2 Message	Initial Value
		High Byte	Low Byte		
BFM #1900	CAN-ID 1 LW	11/29 bit CAN-Identifier low word		RUN>STOP message 1	HFFFF
BFM #1901	CAN-ID 1 HW	29 bit CAN-Identifier high word			HFFFF
BFM #1902	DLC	Data length count			H0
BFM #1903	Data bytes	2nd data byte	1st data byte		H0
BFM #1904		4th data byte	3rd data byte		H0
BFM #1905		6th data byte	5th data byte		H0
BFM #1906		8th data byte	7th data byte		H0
⋮	⋮	⋮	⋮	⋮	⋮

BFM No.	Function	Description		Layer 2 Message	Initial Value
		High Byte	Low Byte		
BFM #1921	CAN-ID 4 LW	11/29 bit CAN-Identifier low word		RUN>STOP message 4	HFFFF
BFM #1922	CAN-ID 4 HW	29 bit CAN-Identifier high word			HFFFF
BFM #1923	DLC	Data length count			H0
BFM #1924	Data bytes	2nd data byte	1st data byte		H0
BFM #1925		4th data byte	3rd data byte		H0
BFM #1926		6th data byte	5th data byte		H0
BFM #1927		8th data byte	7th data byte		H0

BFM Function	Description
11/29 bit CAN-ID n	CAN-ID is used to transmit this message into the network. Sets HFFFF to the CAN-ID n LW and CAN-ID n HW when not using the message.
DLC	High byte H00 = send data frame *1 Low byte = number of data bytes to transmit (K0 to K8)
Data bytes	Data bytes 1 to 8. Number of attached data bytes is defined by DLC.

*1. RTR is prohibited for these messages.

1	Introduction
2	Specifications
3	Installation
4	Wiring
5	Introduction of Functions
6	Allocation of Buffer Memories
7	Interface and Device Profile (405 mode)
8	Lift Application Profile (417 Mode)
9	CAN Layer 2 Mode
10	Command Interface

9.7 CIF Sending Layer 2 Message

Using this function, the FX3U-CAN can send any Layer 2 messages to the CAN bus. This function is accessible only in Layer 2 Mode.

Execution procedure: Set Node guarding/NMT Slave Assignment

- 1) Write the CAN-ID, RTR, DLC and the data byte to BFM #1001 to #1008.
- 2) Write the command code H000C to BFM #1000.
When the command code H000C is written to BFM #1000, the command is executed.
- 3) When the executed command is successful, H000D is written to BFM #1000.
→ If H000F or HFFFF is read from BFM #1000, refer to Section 10.9

BFM No.	Description			
	FROM (Read Access)	TO (Write Access)		
		High Byte	Low Byte	
BFM #1000	H000D: Data written to transmit buffer HF00C: Setting Error HFFFF: CIF Busy H000F: Error	Command: H000C		
BFM #1001	Diagnosis Data	11/29 bit CAN-Identifier low word		
BFM #1002	H0000: No Error	29 bit CAN-Identifier high word		
BFM #1003	HF00C: Setting Error	RTR (Remote Transmission Request)*1		
BFM #1004	All other values: The corresponding parameter caused an error.	DLC (Data Length Count)*2		
BFM #1005	Unused	2nd data byte	1st data byte	
BFM #1006		4th data byte	3rd data byte	
BFM #1007		6th data byte	5th data byte	
BFM #1008		8th data byte	7th data byte	
BFM #1009 to #1066		Unused		

*1. Set this BFM to K0 for normal transmission. If this BFM is set to K1, a remote transmit request frame is sent. This request makes the producer of the associated CAN-ID specified in BFM #1001 and #1002 send the actual data.

*2. The data length in bytes (0 to 8).

10. Command Interface

This chapter describes the Command Interface supported by FX3U-CAN. Command Interface that can be used with each Function Mode is shown in the following table.

Command Interface	Function Mode Selection				Reference
	Mode 405	Mode 417	Mode 11	Mode 29	
SDO Request	✓	✓	-	-	Section 10.2
Set Heartbeat	✓	✓	-	-	Section 10.3
Set Node Guarding / NMT slave assignment	✓	✓	-	-	Section 10.4
Send an Emergency Message	✓	✓	-	-	Section 10.5
Store Object Dictionary settings	✓	✓	-	-	Section 10.6
Restore Object Dictionary default settings	✓	✓	-	-	Section 10.7
Communication Mapping Modes	✓	-	-	-	Section 7.2
Display current Parameter	✓	✓	✓	✓	Section 10.8
Sending Layer 2 Message	-	-	✓	✓	Section 9.7

10.1 [BFM #1000 to #1066] Command Interface

The Command Interface (CIF) can be used to access the Object Dictionary of the local node or a network node. Access is performed by commands for SDO read/write, special direct command for Node Guarding, Heartbeat, PDO Mapping or Emergency Messages.

BFM No.	Description	
	FROM (Read Access)	TO (Write Access)
BFM #1000	Command execution result code	Command code (trigger for command execution)
BFM #1001 to #1066	Command parameter read back or detailed error information	Command parameter

Note

- The TO buffer will not be cleared after command execution. The former written TO data will be display by making new TO accesses or using the Display current Parameter command.
→ Refer to Section 10.8
- Check always before a TO access to the CIF if the BFM #1000 does not display HFFFF (CIF Busy)! If a TO access occurs during CIF busy, it will generate a “Command or Parameter change while CIF was busy” error.
→ Refer to Subsection 10.9.1

- 1 Introduction
- 2 Specifications
- 3 Installation
- 4 Wiring
- 5 Introduction of Functions
- 6 Allocation of Buffer Memories
- 7 Interface and Device Profile (405 mode)
- 8 Lift Application Profile (417 Mode)
- 9 CAN Layer 2 Mode
- 10 Command Interface

10.2 SDO Request

Note that the NMT Master startup process uses SDO's which can be result in an Error of the CIF command if the NMT Startup Master accesses the remote Node at the same time.

10.2.1 CIF SDO read access

Description of CIF SDO read access is shown below.

The local FX3U-CAN can be specified by its actual node number or by using "0".

Execution procedure: CIF SDO read access

- 1) Write the Node number and the Index / Sub-index of the target Object Dictionary to BFM #1001 to #1003.
- 2) Write the command code H0004 for SDO read access to BFM #1000.
When the command code H0004 is written to BFM #1000, the command is executed.
- 3) When the executed command is successful, H0005 is written to BFM #1000.
→ If H000F or HFFFF is read from BFM #1000, refer to Section 10.9
- 4) When H0005 is read from BFM #1000, the specified byte length (BFM #1004) of the result data from BFM #1005 is read. A maximum of 124 bytes of result data is stored in BFM #1005 to #1066.

BFM No.	Description	
	FROM (Read Access)	TO (Write Access)
BFM #1000	H0005: SDO read success H000F: Error HFFFF: CIF Busy	Command H0004: SDO read
BFM #1001	Node number (read back)	Node number
BFM #1002	Index (read back)	Index
BFM #1003	Sub-index (read back)	Sub-index
BFM #1004	Data length	Unused
BFM #1005 to #1066	Result data	Unused

Result Data Structure in BFM #1005 to #1066

BFM No.	Description	
	High Byte	Low Byte
BFM #1005	2nd data byte	1st data byte
BFM #1006	4th data byte	3rd data byte
BFM #1007	6th data byte	5th data byte
BFM #1008	8th data byte	7th data byte
⋮	⋮	⋮
BFM #1065	122nd data byte	121st data byte
BFM #1066	124th data byte	123rd data byte

10.2.2 CIF Multi SDO read access

With the multi SDO read access command, up to 8 SDO read accesses can be made within one command. The maximum data length for each access is 8 bytes.

At first write the node number (0, 1-127), the Object Dictionary Index and the Sub index to the BFM's. Finally the command code for multi SDO read access "8" must be written to BFM #1000 in order to trigger the command execution.

If the access has been successful, BFM #1000 will display "9" and BFM #1001 to #1064 will contain the node number, index and sub index for verification purposes.

BFM No.	Description	
	FROM (Read Access)	TO (Write Access)
BFM #1000	H0009: SDO read success H000F: Error (refer to Section 10.9) H00F9: Error (show Node number and Result data for details) HFFFF: CIF Busy	Command H0008: SDO Multi read
BFM #1001	Success: Node number (read back) Error: High Byte H0F, Low Byte Node number (read back)	Node number
BFM #1002	Index (read back)	Index
BFM #1003	Sub-index (read back)	Low byte: Sub index High byte: reserved
BFM #1004	Success: Data length Error: H0	Unused
BFM #1005	Success: Result data Error: SDO access error code	
BFM #1006		
BFM #1007		
BFM #1008		
⋮	⋮	⋮
BFM #1057	Success: Node number (read back) Error: High Byte H0F, Low Byte Node number (read back)	Node number* ¹
BFM #1058	Index (read back)	Index
BFM #1059	Sub-index (read back)	Low byte: Sub index High byte: reserved
BFM #1060	Success: Data length Error: H0	Unused
BFM #1061	Success: Result data Error: SDO access error code	
BFM #1062		
BFM #1063		
BFM #1064		
BFM #1065 to #1066	Unused	Unused

*1. If the final setting is located before BFM #1057, write HFFFF in the last BFM (Node number).

1

Introduction

2

Specifications

3

Installation

4

Wiring

5

Introduction of
Functions

6

Allocation of
Buffer Memories

7

Interface and
Device Profile
(405 mode)

8

Lift Application
Profile
(417 Mode)

9

CAN Layer 2
Mode

10

Command
Interface

10.2.3 CIF SDO write access

Description of CIF SDO write access is shown below.
The local FX3U-CAN can be specified by its actual node number or by using "0".

Execution procedure: CIF SDO write access

- 1) Write the Node number and the Index / Sub-index of the target Object Dictionary to BFM #1001 to #1003.
- 2) Write the data length (in bytes) to be written, to BFM #1004, and the data to be written, to BFM #1005 to # 1066.
- 3) Write the command code H0002 for SDO write access to BFM #1000.
When the command code H0002 is written to BFM #1000, the command is executed.
- 4) When the executed command is successful, H0003 is written to BFM #1000.
→ If H000F or HFFFF is read from BFM #1000, refer to Section 10.9

BFM No.	Description	
	FROM (Read Access)	TO (Write Access)
BFM #1000	H0003: SDO write success HFFFF: CIF Busy H000F: Error → Refer to Section 10.9	Command H0002: SDO write
BFM #1001	Node number (read back)	Node number
BFM #1002	Index (read back)	Index
BFM #1003	Sub-index (read back)	Sub-index
BFM #1004	Unused	Data length (in byte)
BFM #1005 to #1066	Unused	Command parameter data

Command Parameter Data Structure in BFM #1005 to #1066

BFM No.	Description	
	High Byte	Low Byte
BFM #1005	2nd data byte	1st data byte
BFM #1006	4th data byte	3rd data byte
BFM #1007	6th data byte	5th data byte
BFM #1008	8th data byte	7th data byte
⋮	⋮	⋮
BFM #1065	122nd data byte	121st data byte
BFM #1066	124th data byte	123rd data byte

Example Setting: When changing the NMT state of the whole network to state OPERATIONAL

Write to BFM #1000 to #1005 as follows according to the above-mentioned procedure.

Note

This procedure can only be performed when the FX3U-CAN is set up as the master.

BFM No.	Description	
	FROM (Read Access)	TO (Write Access)
BFM #1000	SDO write success: H0003	Command SDO write: H0002
BFM #1001	Node number (The FX3U-CAN self): H0 (read back)	Node number (The FX3U-CAN self): H0
BFM #1002	Index (Request NMT): H1F82 (read back)	Index (Request NMT): H1F82
BFM #1003	Sub-index (all nodes): H80 (read back)	Sub-index (all nodes): H80
BFM #1004	Unused	Data length (1 byte): K1
BFM #1005		Command parameter data (NMT service remote node): H05
BFM #1006 to #1066		Unused

10.2.4 CIF Multi SDO write access

With the multi SDO write access command, up to 8 SDO write accesses can be made within one command. The maximum data length for each access is 8 bytes.

At first write the node number (0, 1-127), the Object Dictionary Index, the Sub-index, the data length (in byte) and the data to be sent to the BFM.

Finally the command code for multi SDO write access "6" must be written to BFM #1000 in order to trigger the command execution.

If the access has been successful, BFM #1000 will display "7" and the following BFM's will contain the node number, index and sub index for verification purposes number.

BFM No.	Description	
	FROM (Read Access)	TO (Write Access)
BFM #1000	H0007: SDO write success H000F: Error (refer to Section 10.9) H00F7: Error (show Node number and Result data for details) HFFFF: CIF Busy	Command H0006: SDO Multi write
BFM #1001	Success: Node number (read back) Error: High Byte H0F, Low Byte Node number (read back)	Node number
BFM #1002	Index (read back)	Index
BFM #1003	Sub-index (read back)	Low byte: Sub index High byte: reserved
BFM #1004	Unused	Data length (in byte)
BFM #1005	Success: Unused Error: SDO access error code	Command parameter data (1 to 8 byte)
BFM #1006		
BFM #1007		
BFM #1008		
⋮	⋮	⋮
BFM #1057	Success: Node number (read back) Error: High Byte H0F, Low Byte Node number (read back)	Node number* ¹
BFM #1058	Index (read back)	Index
BFM #1059	Sub-index (read back)	Low byte: Sub index High byte: reserved
BFM #1060	Unused	Data length (in byte)
BFM #1061	Success: Unused Error: SDO access error code	Command parameter data (1 to 8 byte)
BFM #1062		
BFM #1063		
BFM #1064		
BFM #1065 to #1066	Unused	Unused

*1. If the final setting is located before BFM #1057, write HFFFF in the last BFM (Node number).

1

Introduction

2

Specifications

3

Installation

4

Wiring

5

Introduction of Functions

6

Allocation of Buffer Memories

7

Interface and Device Profile (405 mode)

8

Lift Application Profile (417 Mode)

9

CAN Layer 2 Mode

10

Command Interface

10.3 Set Heartbeat

Nodes can be easily set to Heartbeat Producer or Heartbeat Consumer status by writing values to Index H1016 and H1017 using the Command Interface (CIF). The parameters for Heartbeat are included in the information that can be written to the CAN bus.

The local FX3U-CAN can be specified by its actual node number or by using "0".

Note that the NMT Master startup process uses SDO's which can be result in an Error of the CIF command if the NMT Startup Master accesses the remote Node at the same time.

→ For Object H1016 and H1017 (Heartbeat), refer to Subsection 5.6.9

1. Heartbeat producing setting

Execution procedure: Heartbeat producing setting

- 1) Write target Node number and Producer heartbeat time value (in units of ms) to BFM #1001 to #1066.
Write HFFFF to the node number following the last target node to complete Heartbeat producing settings.
- 2) Write the command code H7410 to BFM #1000.
When the command code H7410 is written to BFM #1000, the command is executed.
- 3) When the executed command is successful, H7411 is written to BFM #1000.

→ If H741F, H000F or HFFFF is read from BFM #1000, refer to Section 10.9

BFM No.	Description	
	FROM (Read Access)	TO (Write Access)
BFM #1000	H7411: Producing has been assigned H741F: Parameter Error HFFFF: CIF Busy H000F: Error	Command: H7410
BFM #1001	Diagnosis Data H0000: No Error All other values: The corresponding parameter caused an SDO error.	1st target node
BFM #1002		Node number of producer
BFM #1003		Producer heartbeat time value (in units of ms)
BFM #1004		2nd target node
BFM #1005		Node number of producer
BFM #1006		Producer heartbeat time value (in units of ms)
⋮		⋮
BFM #1065		33rd target node
BFM #1066		Node number of producer
		Producer heartbeat time value (in units of ms)

2. Heartbeat consuming setting

With this command, the Heartbeat consuming Index H1016 Sub index K1 to K32 will be set up at the node specified in BFM #1001.

To setup a Sub index higher than K32, use the SDO write command.

→ For Heartbeat, refer to Subsection 5.6.9

→ For SDO Request, refer to Section 10.2

Execution procedure: Heartbeat consuming setting

- 1) Write the Node number that has to be set up to BFM #1001.
The local FX3U-CAN can be specified by its actual node number or by using "0".
- 2) Write target Node-ID to be Consumed and Consumer heartbeat time (in units of ms) to BFM #1002 to #1065.
Write HFFFF to the Node-ID following the last consuming node to complete Heartbeat consuming settings.
- 3) Write the command code H7400 to BFM #1000.
When the command code H7400 is written to BFM #1000, the command is executed.
- 4) When the executed command is successful, H7401 is written to BFM #1000.

→ If H740F, H000F or HFFFF is read from BFM #1000, refer to Section 10.9

BFM No.	Description	
	FROM (Read Access)	TO (Write Access)
BFM #1000	H7401: Consuming has been assigned H740F: Parameter Error HFFFF: CIF Busy H000F: Error	Command: H7400
BFM #1001	Diagnosis Data H0000: No Error All other values: The corresponding parameter caused an SDO error.	Node number which has to be set up
BFM #1002		1st consumed node Node-ID to be consumed
BFM #1003		Consumer heartbeat time (in units of ms)
BFM #1004		2nd consumed node Node-ID to be consumed
BFM #1005		Consumer heartbeat time (in units of ms)
BFM #1006		3rd consumed node Node-ID to be consumed
BFM #1007		Consumer heartbeat time (in units of ms)
⋮		⋮
BFM #1064		32nd consumed node Node-ID to be consumed
BFM #1065		Consumer heartbeat time (in units of ms)
BFM #1066		Reserved

10.4 Set Node Guarding / NMT Slave Assignment

Nodes can be easily set to Guarding-Master or Guarding-Slave status by writing values to Index H1F81 using the Command Interface (CIF). The parameters for guarding are included in the information that can be written to the CAN bus.

The module needs to be NMT Master to use these functions.

→ For Object H1F81, refer to Subsection 5.8.5

Note

- If the node number to be guarded exceeds the range K1 to K127, the corresponding BFM will display the value which caused the problem.
- The FX3U-CAN module may write a value of HFFFF to the "Slave configuration" parameter of a node that has a parameter configuration error.
- The FX3U-CAN module may write a value of HFFFF to the "Guard Time" parameter of a node that has a parameter configuration error.
- If the "Retry Factor" parameter exceeds 255, an error value will be displayed in the corresponding BFM.
- The FX3U-CAN module may write a value of HFFFF to the "Retry Factor" parameter of a node that has a parameter configuration error.
- If the node number, slave configuration, retry factor and guarding time is just copied to the corresponding result BFM, the remote node does not support Index H100C (guarding time)/H100D (retry factor). In this case, the remote node cannot detect a missing guarding request of the network master.

Execution procedure: Set Node guarding/NMT Slave Assignment

- 1) Write the Slave number, Slave Configuration, Guard Time and Retry of the target node to BFM #1001 to #1064. Set the Node-ID of the configured NMT Slave to Slave number. For the setting value of the Slave Configuration, Guard Time and Retry Factor, refer to the following section.
Write HFFFF to the Slave number following the last target node to complete "Node guarding/NMT slave assignment" settings.
→ Refer to Subsection 5.8.7
- 2) Write the command code H8400 to BFM #1000.
When the command code H8400 is written to BFM #1000, the command is executed.
- 3) When the executed command is successful, H8401 is written to BFM #1000.
→ If H84FF, H000F or HFFFF is read from BFM #1000, refer to Section 10.9

BFM No.	Description		
	FROM (Read Access)	TO (Write Access)	
BFM #1000	H8401: Slaves have been assigned H84FF: Parameter Error HFFFF: CIF Busy H000F: Error	Command: H8400	
BFM #1001	Diagnosis Data H0000: No Error All other values: The corresponding parameter caused an error.	1st target node	Slave Number to be Guarded
BFM #1002			Slave Configuration
BFM #1003			Guard Time
BFM #1004			Retry Factor
BFM #1005		2nd target node	Slave Number to be Guarded
BFM #1006			Slave Configuration
BFM #1007			Guard Time
BFM #1008			Retry Factor
⋮		⋮	⋮
BFM #1061		16th target node	Slave Number to be Guarded
BFM #1062			Slave Configuration
BFM #1063			Guard Time
BFM #1064			Retry Factor
BFM #1065		Unused	
BFM #1066		Unused	

10.5 Send an Emergency Message

This command can be used to send an emergency message from the PLC to the CANopen® network.

Execution procedure: Send an emergency message

- Write the Emergency error code^{*1}, Error register and Manufacturer-specific error code^{*2} that will be sent as the Emergency Message to BFM #1001 to #1004.
Unused Manufacturer-specific error code bytes have to be H00.
→ **For Error register, refer to following Subsection 5.6.2**
- Write the command code H000A to BFM #1000.
When the command code H000A is written to BFM #1000, the command is executed.
- When the executed command is successful, H000B is written to BFM #1000.
→ **If H000F or HFFFF is read from BFM #1000, refer to Section 10.9**

BFM No.	Description		
	FROM (Read Access)	TO (Write Access)	
		High Byte	Low Byte
BFM #1000	H000B: Command finished HFFFF: CIF Busy H000C: Communication Error H000F: Error	Command: H000A	
BFM #1001	H0000: No Error H0001: EMCY Inhibit time not elapsed H0002: Device is not in CANopen® state Operational or Pre-operational	Emergency error code ^{*1}	
BFM #1002	Unused	0th byte of Manufacturer-specific error code ^{*2}	Error register
BFM #1003		2nd byte of Manufacturer-specific error code ^{*2}	1st byte of Manufacturer-specific error code ^{*2}
BFM #1004		4th byte of Manufacturer-specific error code ^{*2}	3rd byte of Manufacturer-specific error code ^{*2}
BFM #1005 to #1066		Unused	

*1. Emergency error codes

In different CiA[®] Device/Application Profiles, more EMCY Error Codes are defined.

Error Code (hex)	Description	Error Code (hex)	Description
0000	Error reset or no error	7000	Additional modules – generic error
0010	CiA [®] 417: CAN warning level	8000	Monitoring – generic error
1000	Generic error	8100	Communication – generic
2000	Current – generic error	8110	CAN overrun (objects lost)
2100	Current, CANopen [®] device input side – generic	8120	CAN in error passive mode
2200	Current inside the CANopen [®] device – generic	8130	Life guard error or heartbeat error
2300	Current, CANopen [®] device output side – generic	8140	Recovered from bus off
3000	Voltage – generic error	8150	CAN-ID collision
3100	Mains voltage – generic	8200	Protocol error – generic
3111	CiA [®] 417: Mains Over voltage	8210	PDO not processed due to length error
3121	CiA [®] 417: Mains Under voltage	8220	PDO length exceeded
3200	Voltage inside the CANopen [®] device – generic	8230	DAM MPDO not processed, destination object not available
3211	CiA [®] 417: Over voltage (device internal)	8240	Unexpected SYNC data length
3221	CiA [®] 417: Under voltage (device internal)	8250	RPDO timeout
3300	Output voltage – generic	8F01 to 8F7F	Life guard error or heartbeat error caused by Node-ID 1 to Node-ID 127.
4000	Temperature – generic error	9000	External error – generic error
4100	Ambient temperature – generic	F000	Additional functions – generic error
4200	Device temperature – generic	FF00	Device specific – generic error ^{*2}
5000	CANopen [®] device hardware – generic error	FF01	CiA [®] 417: Light barrier defect ^{*2}
6000	CANopen [®] device software – generic error	FF02	CiA [®] 417: Finger protector defect ^{*2}
6100	Internal software – generic	FF03	CiA [®] 417: Motion detection defect ^{*2}
6200	User software – generic	FF04	CiA [®] 417: Application error, Manufacturer-specific error code: Byte 0 and 1 contain a Text error code, Byte 2 to 4 are reserved ^{*2}
6300	Data set – generic		

*2. For EMCY Manufacturer specific error code, refer to the following section.

→ Refer to Section 6.23

1

Introduction

2

Specifications

3

Installation

4

Wiring

5

Introduction of Functions

6

Allocation of Buffer Memories

7

Interface and Device Profile (405 mode)

8

Lift Application Profile (417 Mode)

9

CAN Layer 2 Mode

10

Command Interface

10.6 Store Object Dictionary Settings

This command is an easy to use command for the store parameter command in the Object Dictionary Index H1010 Sub-index H01.

Note that the NMT Master startup process uses SDO's which can be result in an Error of the CIF SDO command if the NMT Startup Master accesses the remote Node at the same time.

→ For the Object Dictionary Index H1010, refer to Subsection 5.6.11

Execution procedure: Store object dictionary settings

- 1) Write the target node-ID for which Object Dictionary settings are to be stored, to BFM #1001 to #1066.
 When HFFFF is set as node-ID in BFM #1002 to #1066, the "Store Object Dictionary settings" is finished.
 The local FX3U-CAN can be specified by its actual node number or by using "0".
- 2) Write the command code H6000 to BFM #1000.
 When the command code H6000 is written to BFM #1000, the command is executed.
- 3) When the Object Dictionary settings have been saved, H6001 is written to BFM #1000.
 → If H600F, H000F or HFFFF is read from BFM #1000, refer to Section 10.9

BFM No.	Description	
	FROM (Read Access)	TO (Write Access)
BFM #1000	H6001: Object Dictionary settings have been saved H600F: Parameter Error HFFFF: CIF Busy H000F: Error	Command: H6000
BFM #1001	Diagnosis Data	1st target node-ID
⋮	H0000: No Error HFFFF: Parameter caused an error	⋮
BFM #1066		66th target node-ID

10.7 Restore Object Dictionary Default Settings

This command is an easy to use command for the load parameter command in the Object Dictionary Index H1011 Sub-index H01.

The CANopen® devices need to be reset after the command to make the change become effective.

Note that the NMT Master startup process uses SDO's which can be result in an Error of the CIF SDO command if the NMT Startup Master accesses the remote Node at the same time.

→ For the Object Dictionary Index H1011, refer to Subsection 5.6.12

Execution procedure: Restore object dictionary default settings

- 1) Write the target node-ID for which the object dictionary default settings are to be restored, to BFM #1001 to #1066.
When HFFFF is set as node-ID in BFM #1002 to #1066, the "Restore object dictionary factory default settings" is finished.
The local FX3U-CAN can be specified by its actual node number or by using "0".
- 2) Write the command code H6010 to BFM #1000.
When the command code H6010 is written to BFM #1000, the command is executed.
- 3) When the Object Dictionary default settings have been restored, H6011 is written to BFM #1000.
→ If H601F, H000F or HFFFF is read from BFM #1000, refer to Section 10.9
- 4) To activate the default settings, the device has to reboot. Do not use the "Store Object Dictionary Settings" command between the "Restore Object Dictionary Default Settings" command and the Reset command.

BFM No.	Description	
	FROM (Read Access)	TO (Write Access)
BFM #1000	H6011: Object Dictionary default settings have been restored H601F: Parameter Error HFFFF: CIF Busy H000F: Error	Command: H6010
BFM #1001	Diagnosis Data	1st target node-ID
⋮	H0000: No Error HFFFF: Parameter caused an error	⋮
BFM #1066		66th target node-ID

10.8 Display Current Parameter

This command can be used to display the parameter in BFM #1001 to #1066 of the last executed CIF command. If a command caused an error, this function allows the parameter which caused the error to be displayed and to make the necessary adjustments to the parameter set and sequence program.

Execution procedure: Display current parameter

- 1) Write the command code H0000 to BFM #1000.
- 2) When the parameter value of the last executed CIF command has been restored to BFM #1001 to #1066, H0000 is displayed to BFM #1000.*1

→ If HFFFF is read from BFM #1000, refer to Section 10.9

BFM No.	Description	
	FROM (Read Access)	TO (Write Access)
BFM #1000	H0000: Input buffer is displaying. HFFFF: CIF Busy	Command: H0000
BFM #1001 to #1066	Parameter values of the last executed CIF command	Unused

*1. Afterwards, when a new parameter is written to BFM #1000 to #1066, the parameters of the last executed CIF command will be displayed again except for the parameter that was just written.

10.9 Error Messages

10.9.1 Error messages

If an error occurs during the execution of a command, H000F is written to BFM #1000, and the Error Class and additional data are stored to BFM #1001 to BFM #1066.

BFM No.	Description
BFM #1000	Error: H000F
BFM #1001	Error Class
BFM #1002 to #1066	Additional data depending on an Error class

1. When using Unknown command

The written command to BFM #1000 is an unknown command. Confirm the function mode setting and the executed command.

→ For the function mode setting, refer to Section 6.5

→ For command interface that can be executed in each functional mode, refer to Chapter 10

Note

This error will be also occur when a command in this function mode is not supported.

BFM No.	Description
BFM #1000	Error: H000F
BFM #1001	Error Class: H0064
BFM #1002 to #1066	Unused

2. When queue was not available

Access to the internal transmission queue was rejected. Possibly the bus load was too high.

This error may occur during Mode B mapping command execution for errors other than source or destination parameter errors. Please execute again after waiting a little.

BFM No.	Description
BFM #1000	Error: H000F
BFM #1001	Error Class: H8FFF
BFM #1002 to #1066	Unused

3. Command or parameter change while CIF was busy

During FX3U-CAN Command interface execution, HFFFF is written in the read access area of BFM #1000.

During Command interface execution, a new command cannot be executed.

If accessing BFM #1000 to BFM #1066 during the CIF execution, an error may occur, and H000F will be shown in the BFM #1000.

→ For the executing Command interface discontinuance procedure, refer to Subsection 10.9.2

BFM No.	Description
BFM #1000	Error: H000F
BFM #1001	Error Class: HFFFF
BFM #1002 to #1066	Unused

4. Clear/Reset the "CIF was busy" Error

To Reset the CIF after a "Command or Parameter Change while CIF was busy" Error, HFFFF must be written using the TO command to BFM #1000. The CIF is available again if the BFM #1000 displays H0000.

5. SDO error

Node-ID of an error and SDO access abort code are stored in BFM #1002 to #1004.

BFM No.	Description
BFM #1000	Error: H000F
BFM #1001	Error Class: H0003
BFM #1002	Node-ID
BFM #1003	Low Word of SDO access abort code*1
BFM #1004	High Word of SDO access abort code*1
BFM #1005 to #1066	Unused

*1. SDO access abort codes

In different CiA[®] Device/Application Profiles, more SDO access abort codes are defined.

→ For SDO access abort codes that are not in the following table, refer to the manual of the device which sent the message

SDO access abort code (hex)		Description
High Word	Low Word	
0503	0000	Toggle bit not alternated.
0504	0000	SDO protocol timed out. (FX3U-CAN: 500ms)
0504	0001	Client/server command specifier not valid or unknown.
0504	0002	Invalid block size (block mode only).
0504	0003	Invalid sequence number (block mode only).
0504	0004	CRC error (block mode only).
0504	0005	Out of memory.
0601	0000	Unsupported access to an object.
0601	0001	Attempt to read a write only object.
0601	0002	Attempt to write a read only object.
0602	0000	Object does not exist in the object dictionary.
0604	0041	Object cannot be mapped to the PDO.
0604	0042	The number and length of the objects to be mapped would exceed PDO length.
0604	0043	General parameter incompatibility reason.
0604	0047	General internal incompatibility in the device.
0606	0000	Access failed due to a hardware error.
0607	0010	Data type does not match, length of service parameter does not match
0607	0012	Data type does not match, length of service parameter too high
0607	0013	Data type does not match, length of service parameter too low
0609	0011	Sub-index does not exist.
0609	0030	Invalid value for parameter (download only).
0609	0031	Value of parameter written too high (download only).
0609	0032	Value of parameter written too low (download only).
0609	0036	Maximum value is less than minimum value.
060A	0023	Resource not available: SDO connection
0800	0000	General error
0800	0020	Data cannot be transferred or stored to the application.
0800	0021	Data cannot be transferred or stored to the application because of local control.
0800	0022	Data cannot be transferred or stored to the application because of the present device state.
0800	0023	Object dictionary dynamic generation fails or no object dictionary is present
0800	0024	No data available
5000	0000	Time out or impossible to allocate identifier for SDO transmission or Protocol mismatch
6060	0000	Buffer too small for received SDO data (this error will occur during initialization of the transmission)

1

Introduction

2

Specifications

3

Installation

4

Wiring

5

Introduction of Functions

6

Allocation of Buffer Memories

7

Interface and Device Profile (405 Mode)

8

Lift Application Profile (417 Mode)

9

CAN Layer 2 Mode

10

Command Interface

6. Bus off

The FX3U-CAN is in Bus off and cannot send CAN messages.

BFM No.	Description
BFM #1000	Error: H000F
BFM #1001	Error Class: HB0FF
BFM #1002 to #1066	Unused

7. Device in wrong state

The state of the FX3U-CAN cannot execute the requested command interface.

Confirm the function mode setting and the state of FX3U-CAN.

→ **For the function mode setting, refer to Section 6.5**

→ **For command interface which can be executed in each functional mode, refer to Chapter 10**

→ **For the FX3U-CAN status, refer to Section 6.8**

BFM No.	Description
BFM #1000	Error: H000F
BFM #1001	Error Class: H0F0F
BFM #1002 to #1066	Unused

10.9.2 CIF busy message

During FX3U-CAN Command interface execution, HFFFF is written in the read access area of BFM #1000.

During Command interface execution, a new command cannot be executed.

If a new command will be executed or a parameter of the running command will be changed, discontinue the executing command by using the following method.

If BFM #1000 to BFM #1066 are written to during command interface execution, an error may occur, and H000F will be written to BFM #1000.

→ **For error message, refer to Subsection 10.9.1**

Executing Command interface discontinuance procedure

- 1) Write HFFFF to BFM #1000 to discontinue the processing command.
- 2) If the executed command is reset, H0000 is displayed in BFM #1000.
- 3) The CIF is available again when BFM #1000 is H0000.

11. PLC RUN/STOP

STARTUP AND MAINTENANCE PRECAUTIONS



- Before modifying or disrupting the program in operation or running the PLC, carefully read through this manual and the associated manuals and ensure the safety of the operation.
An operation error may damage the machinery or cause accidents.

FX3U-CAN operates as follows when the STOP/RUN state of the PLC changes.

1. CANopen[®] NMT Slave

- RUN→STOP
FX3U-CAN changes into the CANopen[®] state as set in the Error behaviour Object. In addition an EMCY is sent.
→ **For Error behaviour, refer to Section 5.7**
→ **For EMCY, refer to Subsection 5.6.13**
- STOP→RUN
FX3U-CAN stays in the current CANopen[®] state.

2. CANopen[®] NMT Master without Flying Master function

- RUN→STOP
FX3U-CAN changes into the CANopen[®] state as set in the Error behaviour Object. The NMT Master Entity, the Heartbeat producing and the Node Guarding will be stopped. NMT Slaves with Heartbeat consuming or Life Guarding have the possibility to respond to the loss of the NMT Master. In addition an EMCY is sent.
→ **For Error behaviour, refer to Section 5.7**
→ **For EMCY, refer to Subsection 5.6.13**
- STOP→RUN
The Module enables Heartbeat and NMT Master services again, and starts the NMT Master startup service.
→ **For NMT Master startup, refer to Subsection 5.8.5**

3. CANopen[®] NMT Master with Flying Master function

- RUN→STOP
FX3U-CAN changes into the CANopen[®] state as set in the Error behaviour Object. The NMT Master Entity, the Heartbeat producing and the Node Guarding will be stopped. Other NMT Flying Masters will start a Flying Master negotiation if the Module was the active NMT Master. In addition an EMCY is sent.
→ **For Error behaviour, refer to Section 5.7**
→ **For EMCY, refer to Subsection 5.6.13**
- STOP→RUN
The Module enables Heartbeat and NMT Master services again, and starts a Flying Master negotiation.
→ **For Flying Master, refer to Subsection 5.8.11**

4. Layer 2

- RUN→STOP
FX3U-CAN sends the PLC RUN>STOP message (if configured) and changes into Offline state after this.
- STOP→RUN
FX3U-CAN stays in the current state.

12. Communication Settings Procedure

STARTUP AND MAINTENANCE PRECAUTIONS



WARNING

- Do not touch any terminal while the PLC's power is on.
Doing so may cause electric shock or malfunctions.
- Before cleaning or retightening terminals, cut off all phases of the power supply externally.
Failure to do so may cause electric shock.
- Before modifying or disrupting the program in operation or running the PLC, carefully read through this manual and the associated manuals and ensure the safety of the operation.
An operation error may damage the machinery or cause accidents.

STARTUP AND MAINTENANCE PRECAUTIONS



CAUTION

- Do not disassemble or modify the PLC.
Doing so may cause fire, equipment failures, or malfunctions.
For repair, contact your local Mitsubishi Electric representative.
- Turn off the power to the PLC before connecting or disconnecting any extension cable.
Failure to do so may cause equipment failures or malfunctions.
- Do not drop the product or exert strong impact to it.
Doing so may cause damage.
- Turn off the power to the PLC before attaching or detaching the following devices.
Failure to do so may cause equipment failures or malfunctions.
 - Peripheral devices, display module, expansion boards, and special adapters
 - Input/output extension units/blocks, FX Series terminal blocks and special function units/blocks
 - Battery and memory cassette

12.1 CANopen® 405 Mode

When using CANopen® 405 mode, the outline of the communication setting procedure is as follows.

To set the Object Dictionary and the TPDO/RPDO mapping, the use of CANopen® configuration software is recommended.

- For further information on CANopen® configuration software, refer to the manual of the software to be used
- For further information on the Object Dictionary, refer to Chapter 5
 - For further information on BFM s, refer to Chapter 6
- For further information on data transfer location and PDO mapping, refer to Chapter 7
 - For further information on the CIF, refer to Chapter 10
 - For example program, refer to Chapter 13

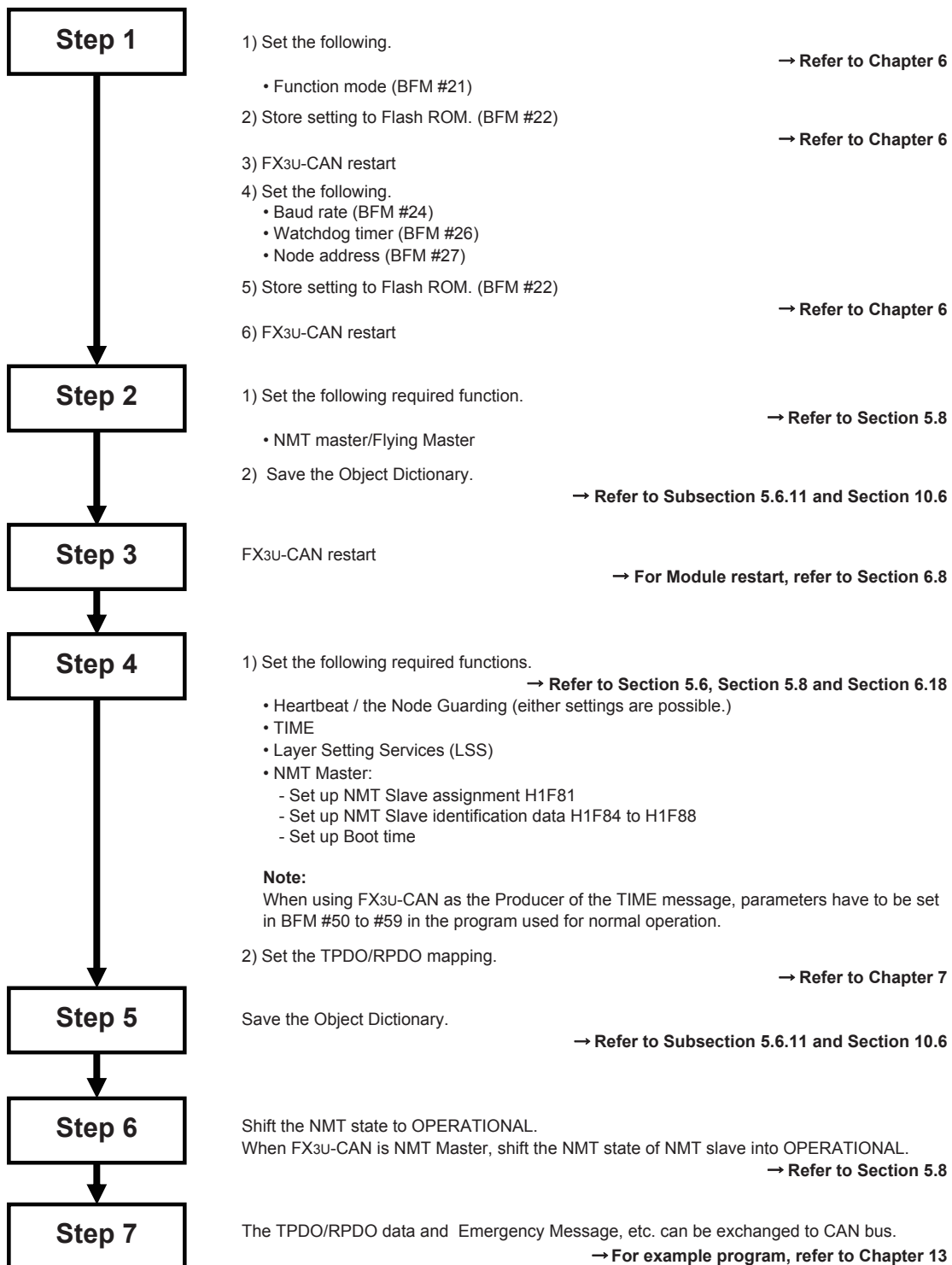

12.2 CANopen® 417 Mode

When using CANopen® 417 mode, the outline of the communication setting procedure is as follows.

To set the Object Dictionary, the use of CANopen® configuration software is recommended.

- For further information on CANopen® configuration software, refer to the manual of the software to be used
- For further information on the Object Dictionary, refer to Chapter 5
 - For further information on BFMs, refer to Chapter 6
- For further information on data transfer location, refer to Chapter 8
 - For further information on the CIF, refer to Chapter 10
 - For example program, refer to Chapter 13

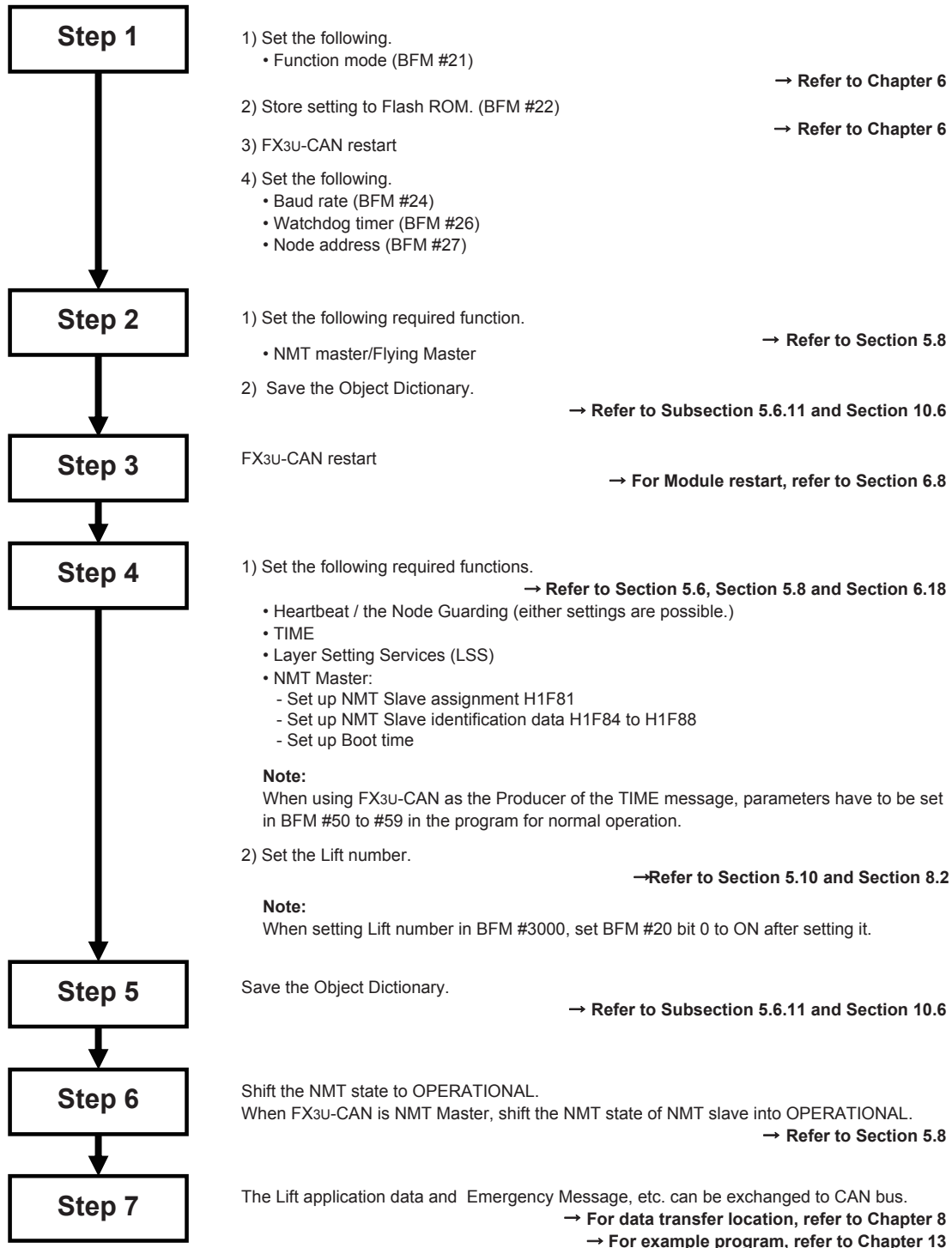

12.3 11 bit / 29 bit CAN-ID Layer 2 Mode

When using the 11 bit / 29 bit CAN-ID Layer 2 Mode, the outline of the communication setting procedure is as follows.

- For further information on BFMs, refer to Chapter 6
- For further information on data transfer location, refer to Chapter 9
- For the CIF available in these modes, refer to Chapter 9
- For example program, refer to Chapter 13

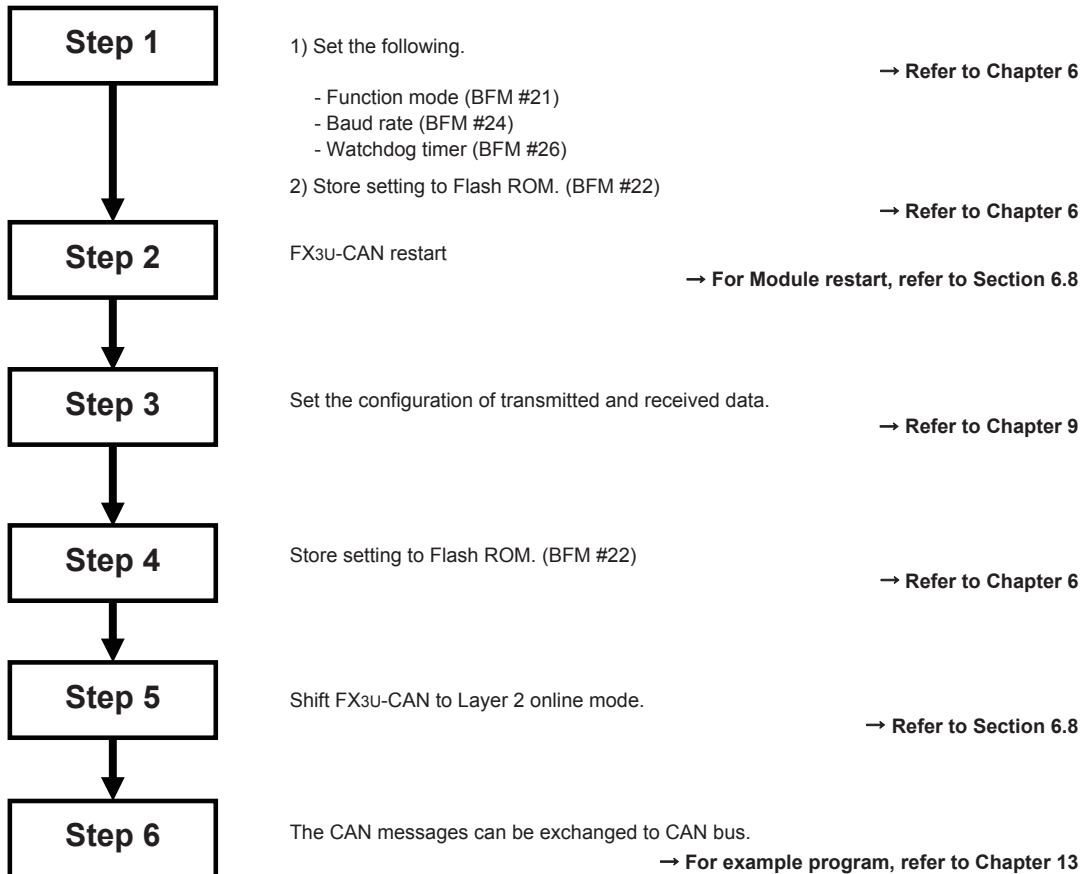

13. Program Example

STARTUP AND MAINTENANCE PRECAUTIONS	 WARNING
<ul style="list-style-type: none"> Do not touch any terminal while the PLC's power is on. Doing so may cause electric shock or malfunctions. Before cleaning or retightening terminals, cut off all phases of the power supply externally. Failure to do so may cause electric shock. Before modifying or disrupting the program in operation or running the PLC, carefully read through this manual and the associated manuals and ensure the safety of the operation. An operation error may damage the machinery or cause accidents. 	

STARTUP AND MAINTENANCE PRECAUTIONS	 CAUTION
<ul style="list-style-type: none"> Do not disassemble or modify the PLC. Doing so may cause fire, equipment failures, or malfunctions. For repair, contact your local Mitsubishi Electric representative. Turn off the power to the PLC before connecting or disconnecting any extension cable. Failure to do so may cause equipment failures or malfunctions. Do not drop the product or exert strong impact to it. Doing so may cause damage. Turn off the power to the PLC before attaching or detaching the following devices. Failure to do so may cause equipment failures or malfunctions. <ul style="list-style-type: none"> Peripheral devices, display module, expansion boards, and special adapters Input/output extension units/blocks, FX Series terminal blocks and special function units/blocks Battery and memory cassette 	

The Programs shown below are examples of how to set local parameters, set up a CANopen[®] network, and exchange data over the CANopen[®] bus with the FX3U-CAN. Large networks can be configured more quickly and easily by using a CANopen[®] configuration tool instead.

Note

These program examples together with the Function blocks can be downloaded from <http://eu3a.mitsubishielectric.com/fa/en/> in the MyMitsubishi section (free registration necessary).

Note

The sample ladder program use labels.

→ For label setting operation on GX Works2, refer to GX Works2 Version 1 Operating Manual (Simple Project)

13.1 System Configuration

The sample Program sets up the initial BFM and Object dictionary settings and starts PDO Communication.

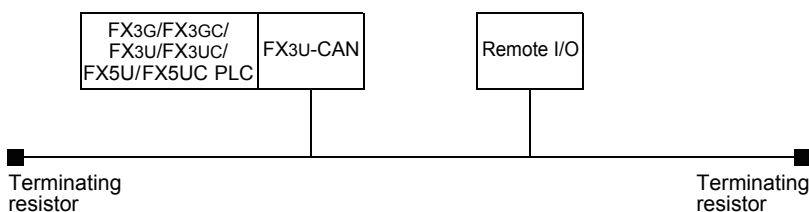

13.2 Local Label Setting

No.	Class	Label Name	Data Type
1	VAR	CANID	Word[Unsigned]/Bit String[16-bit]
2	VAR	CommandSequence	Word[Signed]
3	VAR	NMTMasterSetError	Bit
4	VAR	NMTMasterSetErrorCount	Word[Signed]
5	VAR	NMTMasterSetCompleted	Bit
6	VAR	NMTMasterSetOkCount	Word[Signed]
7	VAR	ConsumedNodeAddress	Word[Signed](0..32)
8	VAR	ConsumerHeartbeatTime	Word[Signed](0..32)
9	VAR	ConsumerSetupError	Bit
10	VAR	ConsumerSetupErrorCounter	Word[Signed]
11	VAR	ConsumerSetupCompleted	Bit
12	VAR	ConsumerSetupOkCounter	Word[Signed]
13	VAR	ConsumingNodeID	Word[Signed]
14	VAR	ErrorReset	Bit
15	VAR	ErrorStatus	Word[Unsigned]/Bit String[16-bit]
16	VAR	ExecuteMapping	Bit
17	VAR	FillData	Word[Unsigned]/Bit String[16-bit]
18	VAR	FirstPDOProcessing	Bit
19	VAR	FourthPDOProcessing	Bit
20	VAR	FX3UCANOpenInit	CANopenInit
21	VAR	FX3UMasterSetup	NMTMasterSettings
22	VAR	GuardedTime	Word[Signed](0..15)
23	VAR	HeartbeatConsumer	HeartbeatConsumerSetup
24	VAR	HeartbeatConsumingSetting	Bit
25	VAR	HeartbeatProducer	HeartbeatProducerSetup
26	VAR	HeartbeatProducerSetting	Bit
27	VAR	Master	Bit
28	VAR	MasterNodeAddress	Word[Signed]
29	VAR	NodeAddress	Word[Signed]
30	VAR	NodeHeartbeatStatus	Word[Unsigned]/Bit String[16-bit](0..126)
31	VAR	NodeNMTStatus	Word[Unsigned]/Bit String[16-bit](0..2)
32	VAR	NoOfConsumedNodes	Word[Signed]
33	VAR	NoOfEntries	Word[Signed]
34	VAR	NoOfProducingNodes	Word[Signed]
35	VAR	NumberOfSlaveNodes	Word[Signed]
36	VAR	ObjectIndex	Word[Unsigned]/Bit String[16-bit](1..8)
37	VAR	ObjectLength	Word[Unsigned]/Bit String[16-bit](1..8)
38	VAR	ObjectSubindex	Word[Unsigned]/Bit String[16-bit](1..8)
39	VAR	Operational	Bit
40	VAR	PDONumber	Word[Signed]
41	VAR	PdoRead	PDORead
42	VAR	PDOReadData	Word[Unsigned]/Bit String[16-bit](0..3)
43	VAR	PDOSetupError	Bit
44	VAR	PDOSetupErrCounter	Word[Signed]
45	VAR	PDOSetupOkCounter	Word[Signed]
46	VAR	PDOSetupProcessing	Bit
47	VAR	PdoWrite	PDOWrite
48	VAR	PDOWriteData	Word[Unsigned]/Bit String[16-bit](0..3)
49	VAR	PreOperational	Bit
50	VAR	ProducerHeartbeatTime	Word[Signed](0..32)
51	VAR	ProducerNodeID	Word[Signed](0..32)
52	VAR	ProducerSetupError	Bit

No.	Class	Label Name	Data Type
53	VAR	ProducerSetupErrorCounter	Word[Signed]
54	VAR	ProducerSetupCompleted	Bit
55	VAR	ProducerSetupOkCounter	Word[Signed]
56	VAR	SDOReadCompleted	Bit
57	VAR	ReadData	Word[Unsigned]/Bit String[16-bit](0..61)
58	VAR	ReadDataLength	Word[Signed]
59	VAR	SDOReadErrorCode	Double Word[Unsigned]/Bit String[32-bit]
60	VAR	SDOReadError	Bit
61	VAR	SDOReadErrorCounter	Word[Signed]
62	VAR	ReadIndex	Word[Unsigned]/Bit String[16-bit]
63	VAR	ReadNodeAddress	Word[Signed]
64	VAR	ReadSubIndex	Word[Unsigned]/Bit String[16-bit]
65	VAR	ReceiveOrTransmit	Bit
66	VAR	ReleaseAnalogInputdata	Bit
67	VAR	RemoteNodeID	Word[Unsigned]/Bit String[16-bit]
68	VAR	NMTRequestCompleted	Bit
69	VAR	RequestData	Word[Unsigned]/Bit String[16-bit]
70	VAR	NMTRequestError	Bit
71	VAR	NMTRequestErrorCounter	Word[Signed]
72	VAR	RetryFactor	Word[Signed](0..15)
73	VAR	RPDOnumber	Word[Signed]
74	VAR	SDOReadCommand	SDORead
75	VAR	SDOReadRequest	Bit
76	VAR	SDOwriteCommand	SDOWrite
77	VAR	SecondPDOProcessing	Bit
78	VAR	ExecNMTMasterConfig	Bit
79	VAR	SetupPDOs	PDOSetup
80	VAR	SlaveConfiguration	Word[Signed](0..15)
81	VAR	NMTSlaveSetup	NMTSlaveSettings
82	VAR	NMTSlaveSetupError	Bit
83	VAR	NMTSlaveSetupErrorCounter	Word[Signed]
84	VAR	NMTSlaveSetCompleted	Bit
85	VAR	NMTSlaveSetupOkCounter	Word[Signed]
86	VAR	StartAllNodes	Bit
87	VAR	StartCANOpenNodes	NMTRequestWrite
88	VAR	StartConsumerSetup	Bit
89	VAR	StartPDOCommunication	Bit
90	VAR	StartPDORead	Bit
91	VAR	StartPDOSetup	Bit
92	VAR	StartPDOWrite	Bit
93	VAR	StartProducerSetup	Bit
94	VAR	StartNMTRequest	Bit
95	VAR	StartSDORead	Bit
96	VAR	StartSDOWrite	Bit
97	VAR	StartNMTSlaveSetup	Bit
98	VAR	StartupConfigurationValue	Word[Unsigned]/Bit String[16-bit]
99	VAR	TargetSlaveNumber	Word[Signed](0..15)
100	VAR	ThirdPDOProcessing	Bit
101	VAR	TPDOnumber	Word[Signed]
102	VAR	TransmissionType	Word[Unsigned]/Bit String[16-bit]
103	VAR	MELSEC_STliteHeartbeatActive	Bit
104	VAR	MELSEC_STlitePreOperational	Bit
105	VAR	SDOWriteCompleted	Bit
106	VAR	WriteData	Word[Unsigned]/Bit String[16-bit](0..61)
107	VAR	WriteDataLength	Word[Signed]

No.	Class	Label Name	Data Type
108	VAR	SDOWriteErrorCode	Double Word[Unsigned]/Bit String[32-bit]
109	VAR	SDOWriteError	Bit
110	VAR	SDOWriteErrorCounter	Word[Signed]
111	VAR	WriteIndex	Word[Unsigned]/Bit String[16-bit]
112	VAR	WriteNodeAddress	Word[Signed]
113	VAR	WriteSubIndex	Word[Unsigned]/Bit String[16-bit]
114	VAR	SDOWriteOkCounter	Word[Signed]
115	VAR	PDOSetupCompleted	Bit
116	VAR	NMTRequestOkCounter	Word[Signed]
117	VAR	SDOReadOKCounter	Word[Signed]
118	VAR	InitComplete	Bit
119	VAR	StartCommunication	Bit
120	VAR	SlaveSettingsSetup	Bit
121	VAR	StartNode	Word[Signed]
122	VAR	NumberOfNodes	Word[Signed]
123	VAR	MELSEC_STliteOperational	Bit
124	VAR	NMTStatusRead	NMTStatus
125	VAR	CheckNMTStatus	Bit
126	VAR	HeartbeatStatusRead	HeartbeatStatus
127	VAR	CheckHeartbeatStatus	Bit
128	VAR	Stopped	Bit

13.3 Program

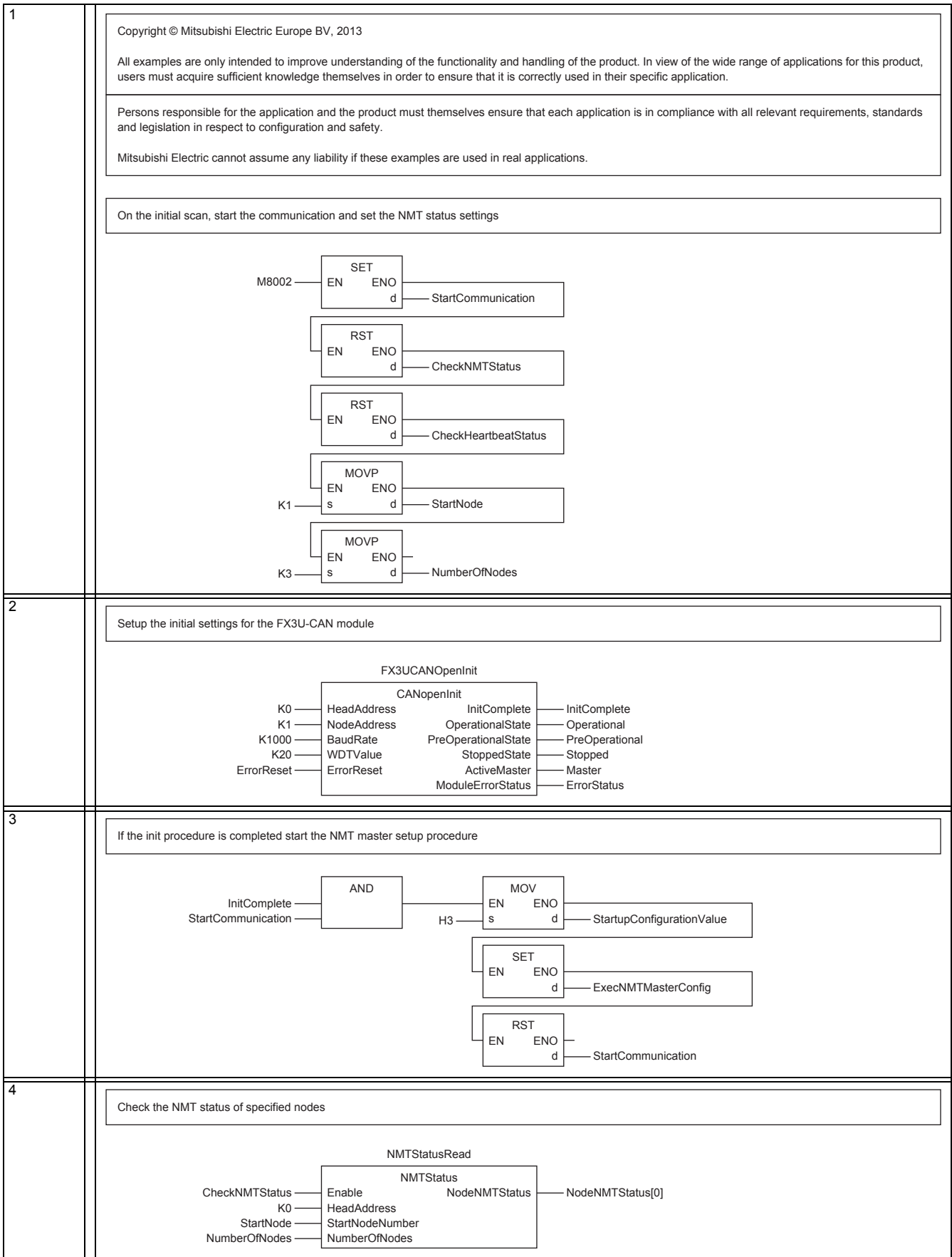

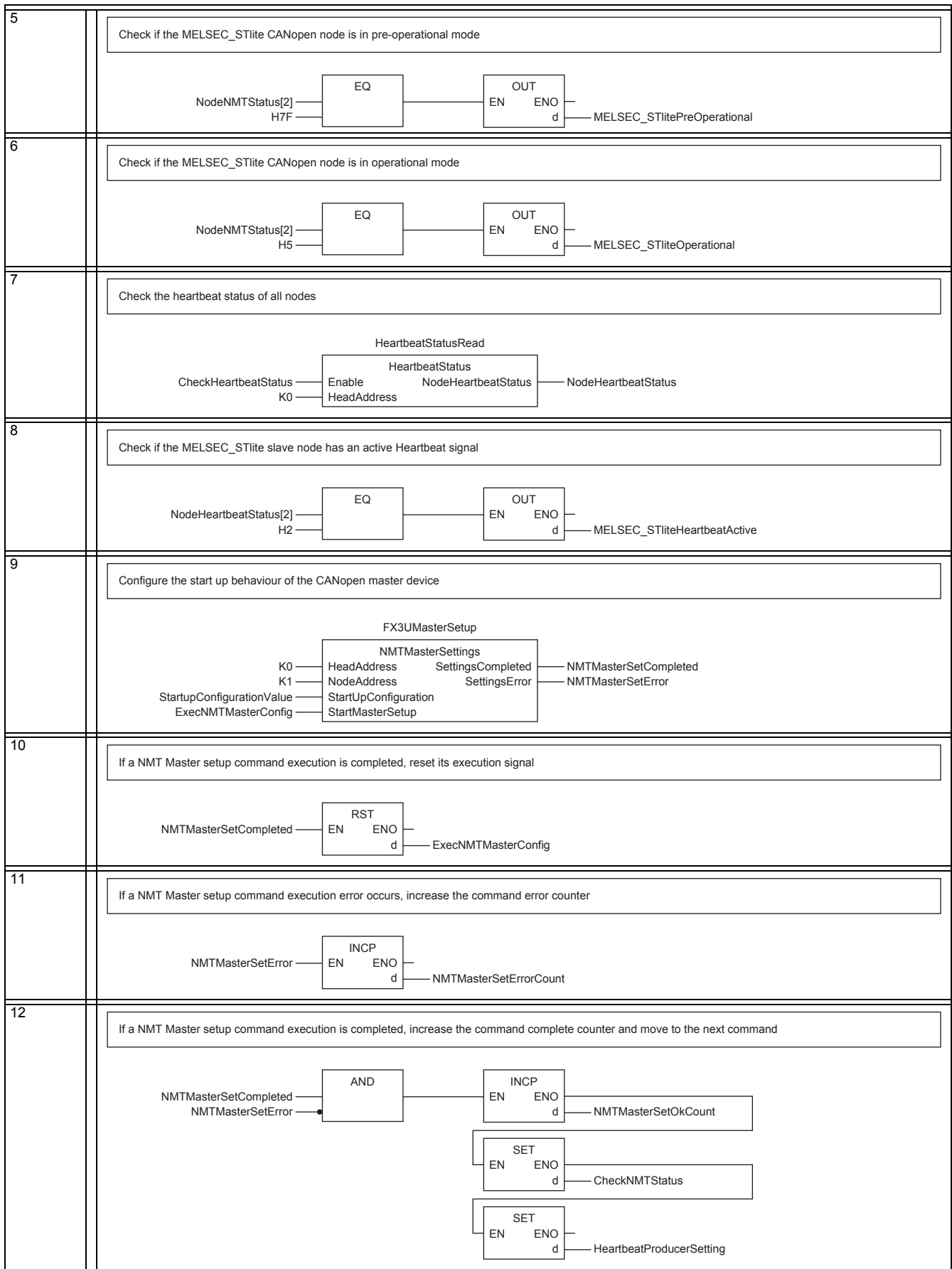

11
PLC
RUN/STOP

12
Communication
Settings
Procedure

13
Program
Example

14
Diagnostics

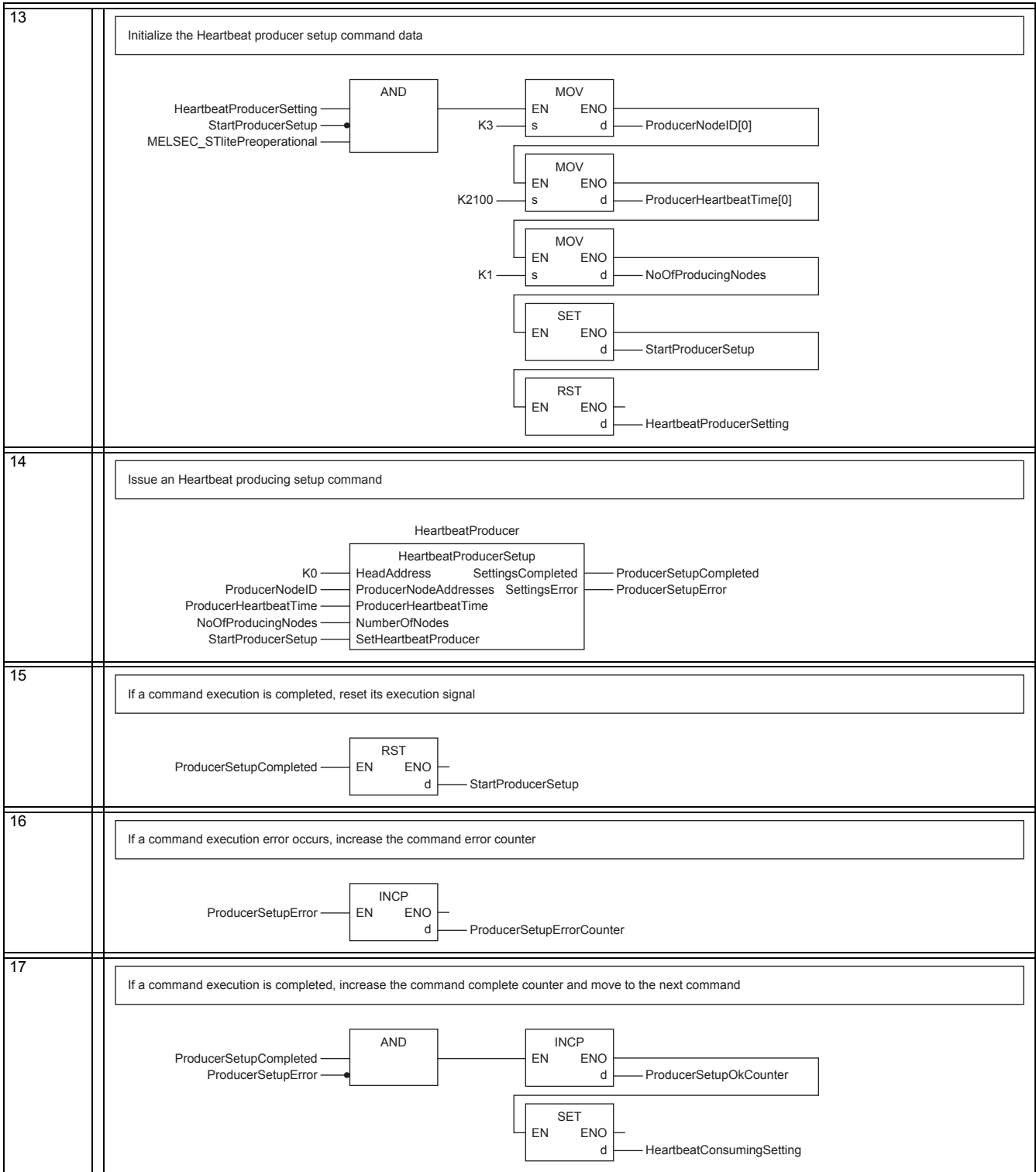

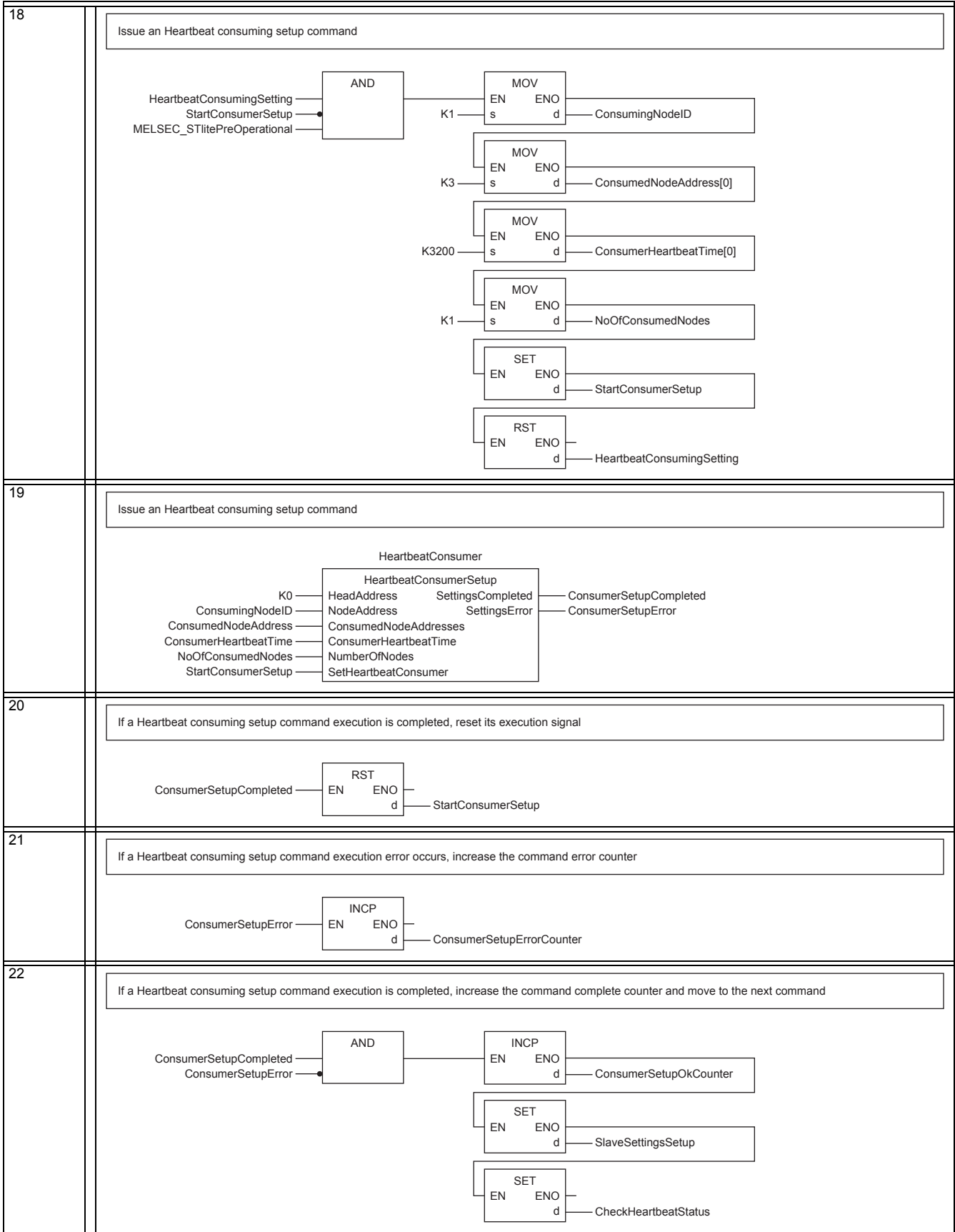

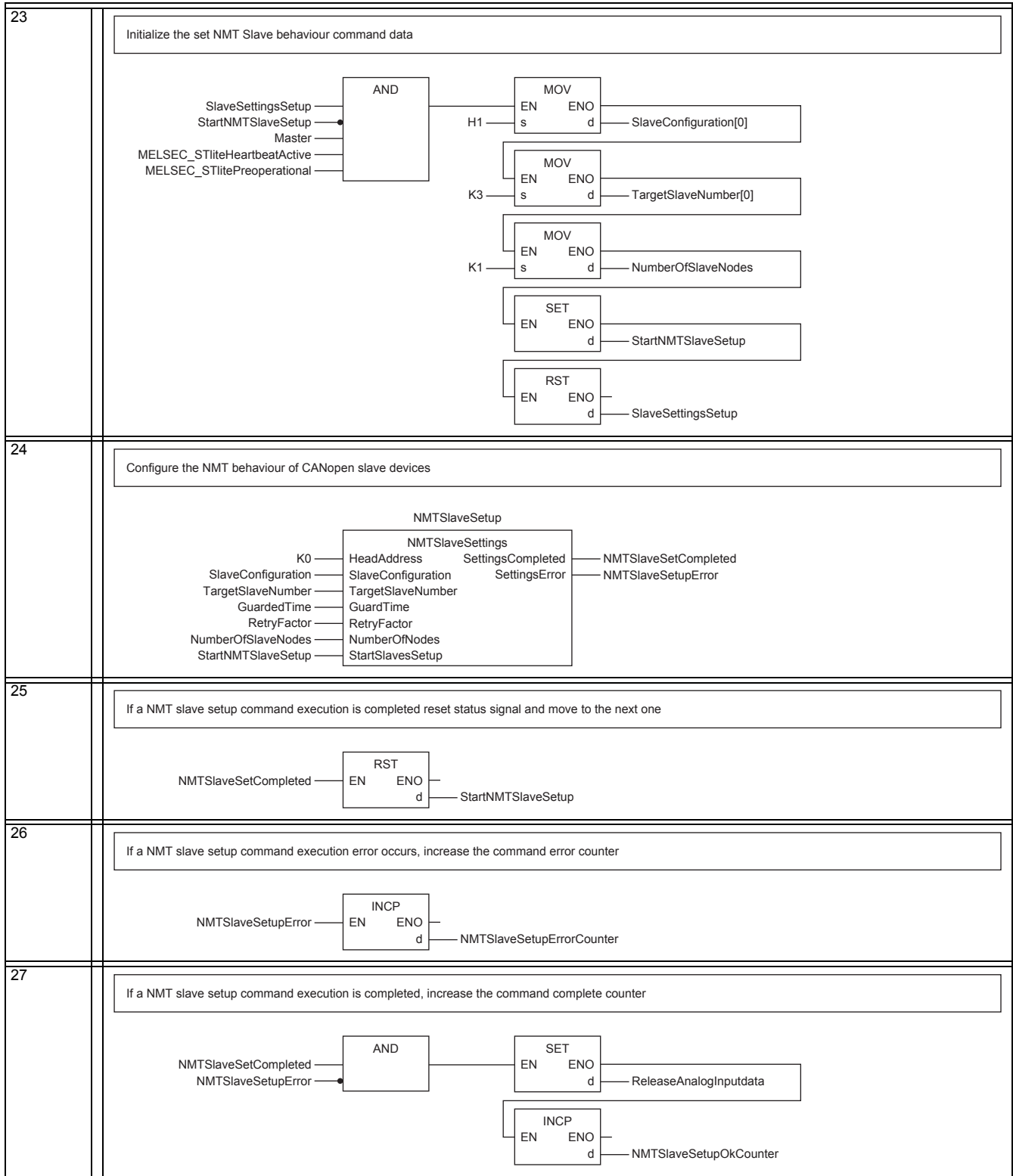

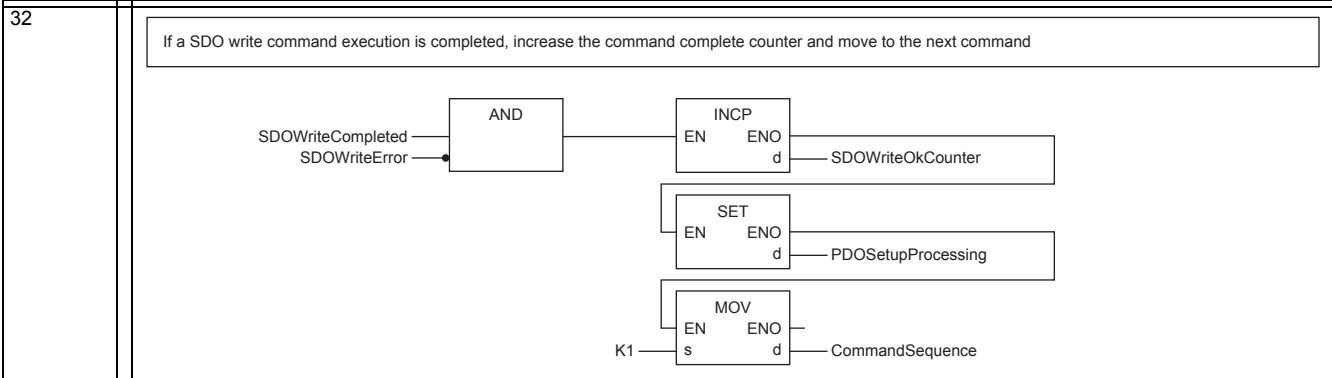
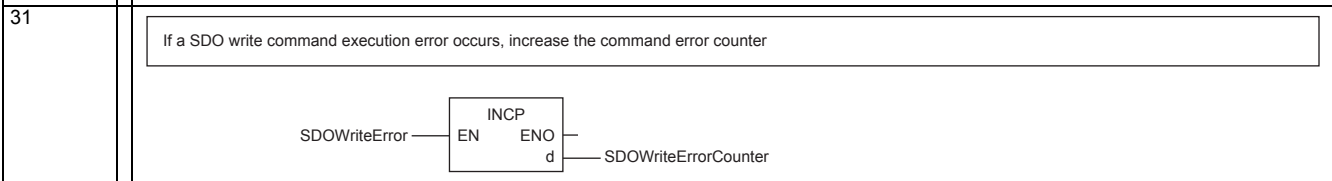
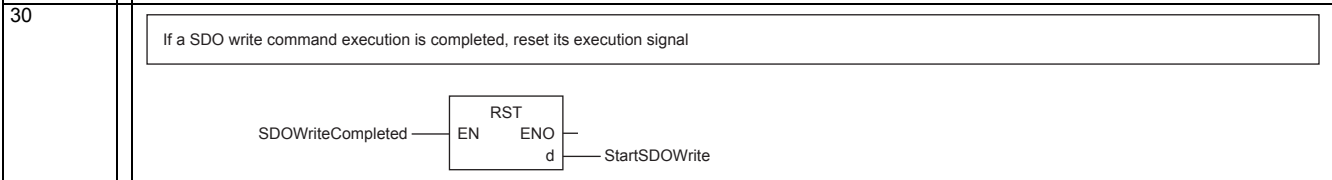
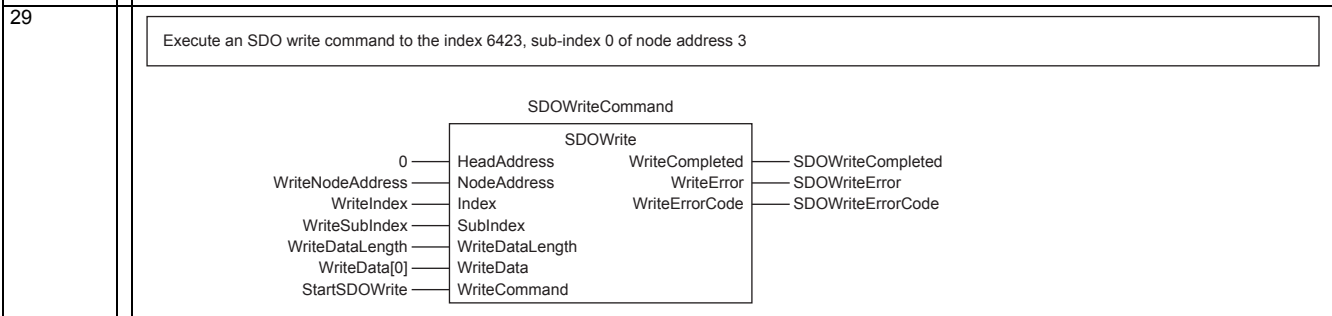
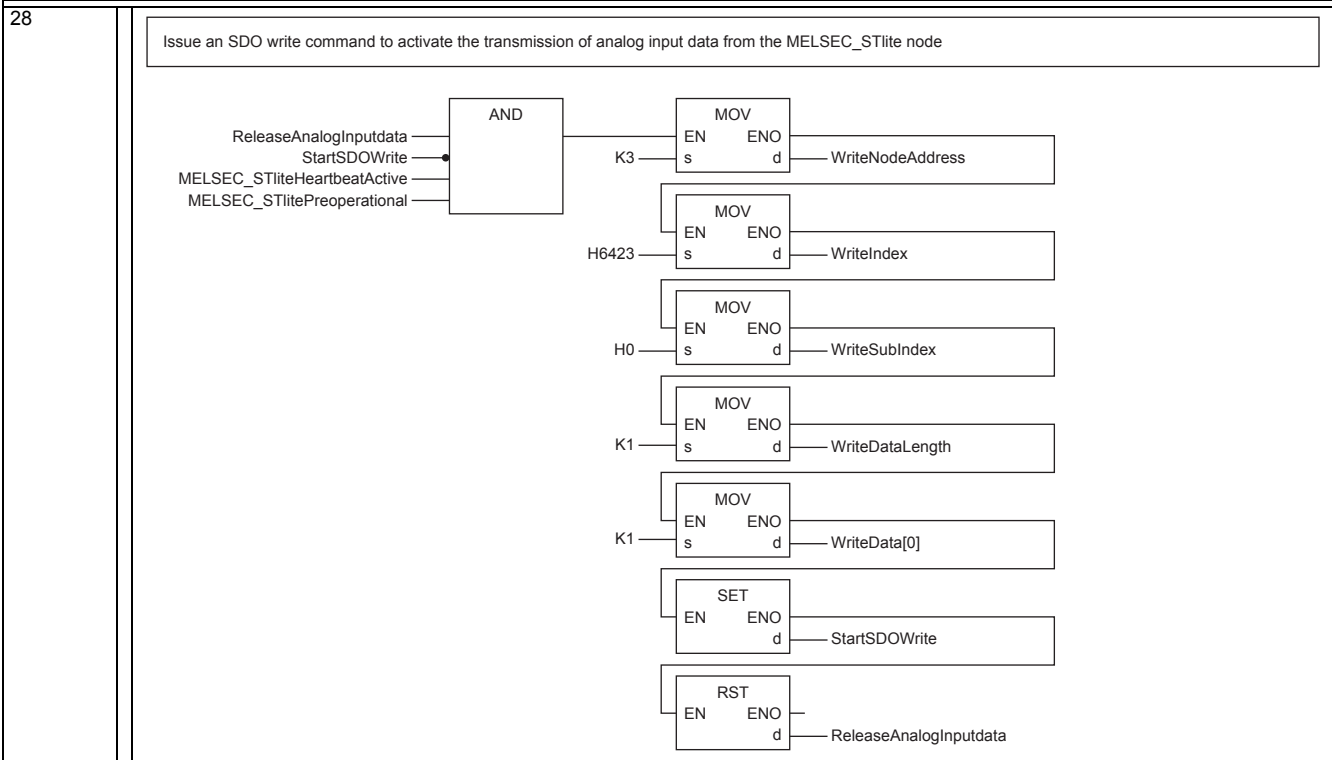

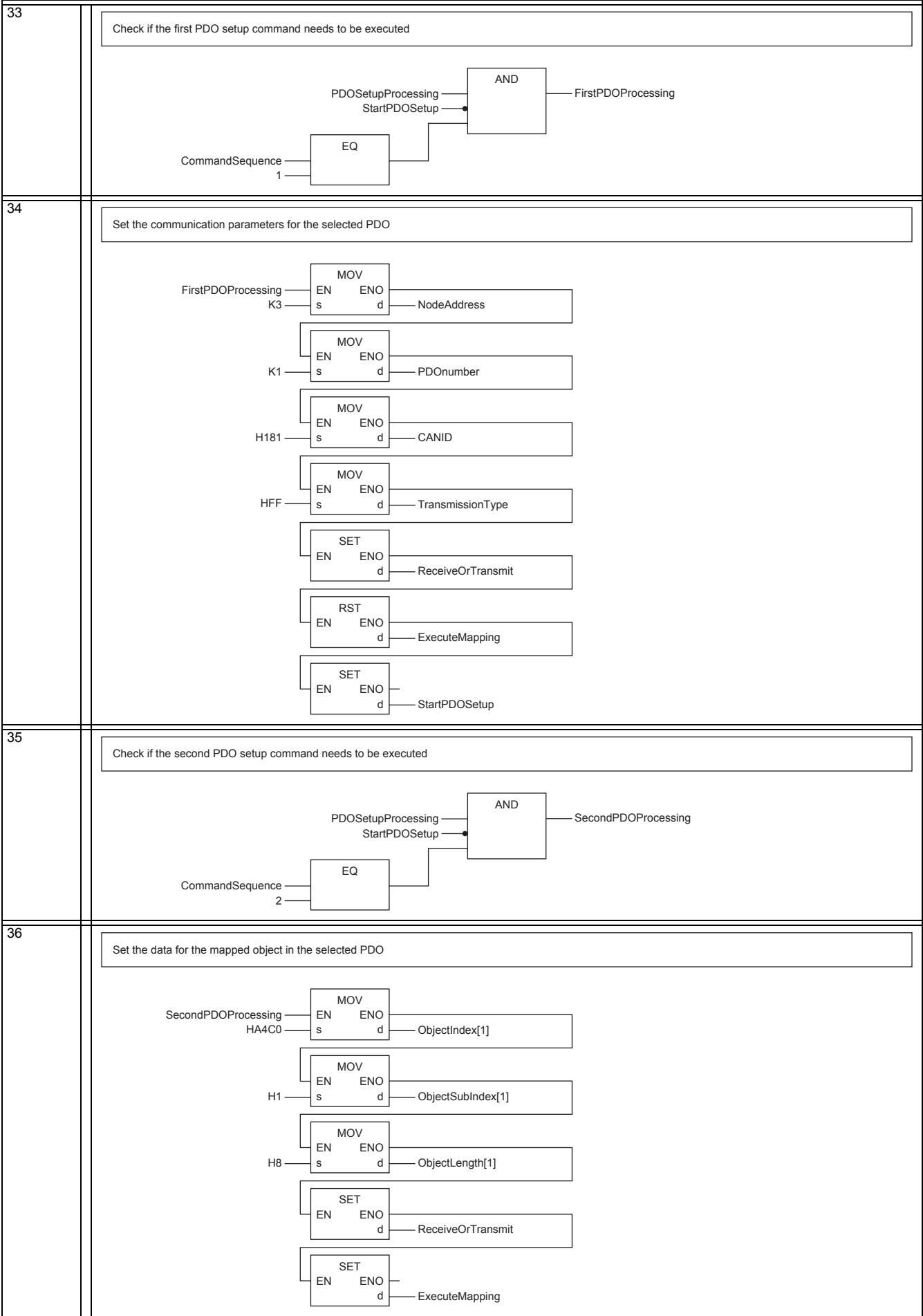

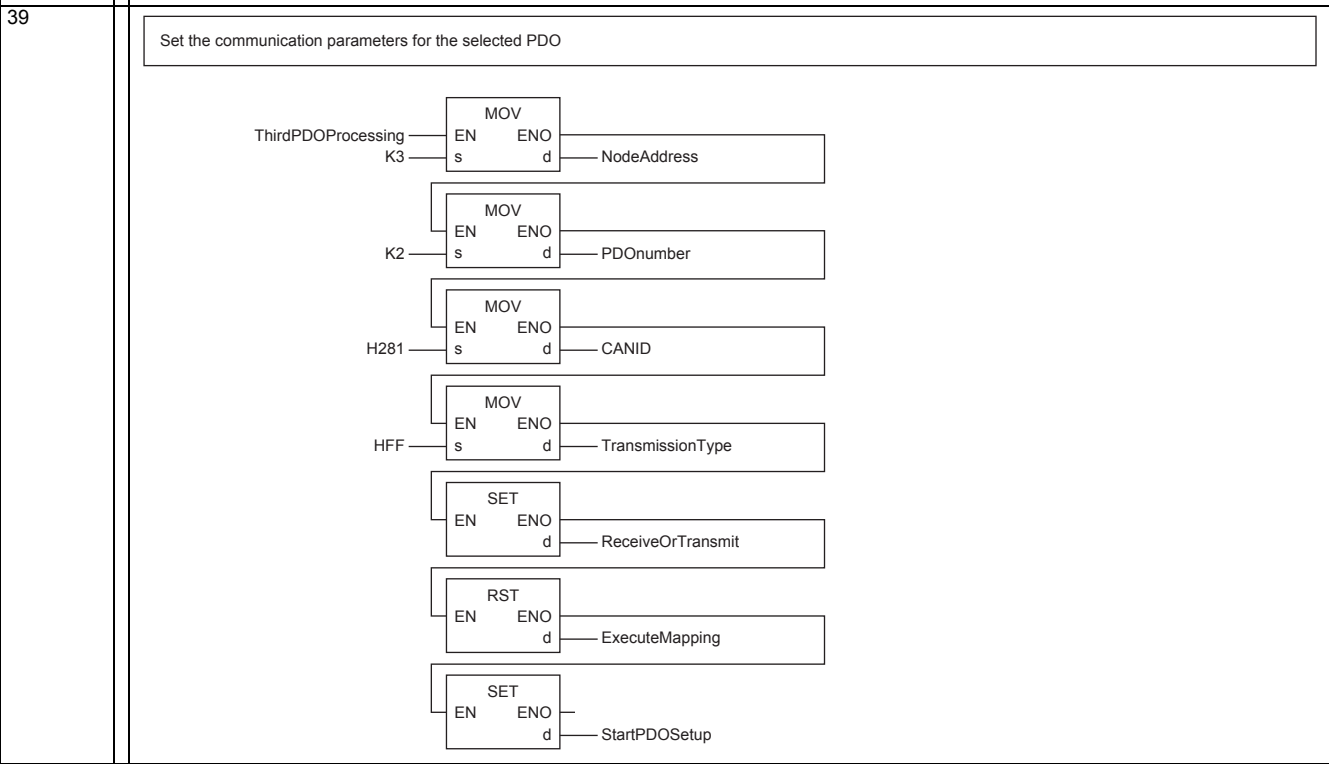
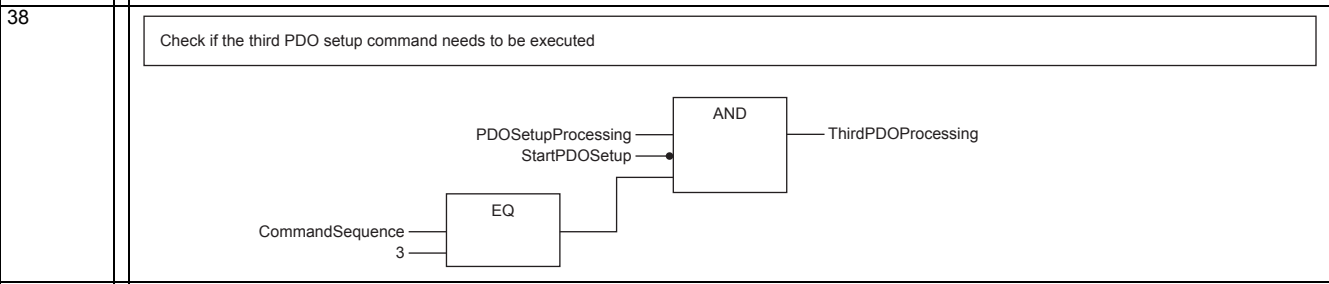
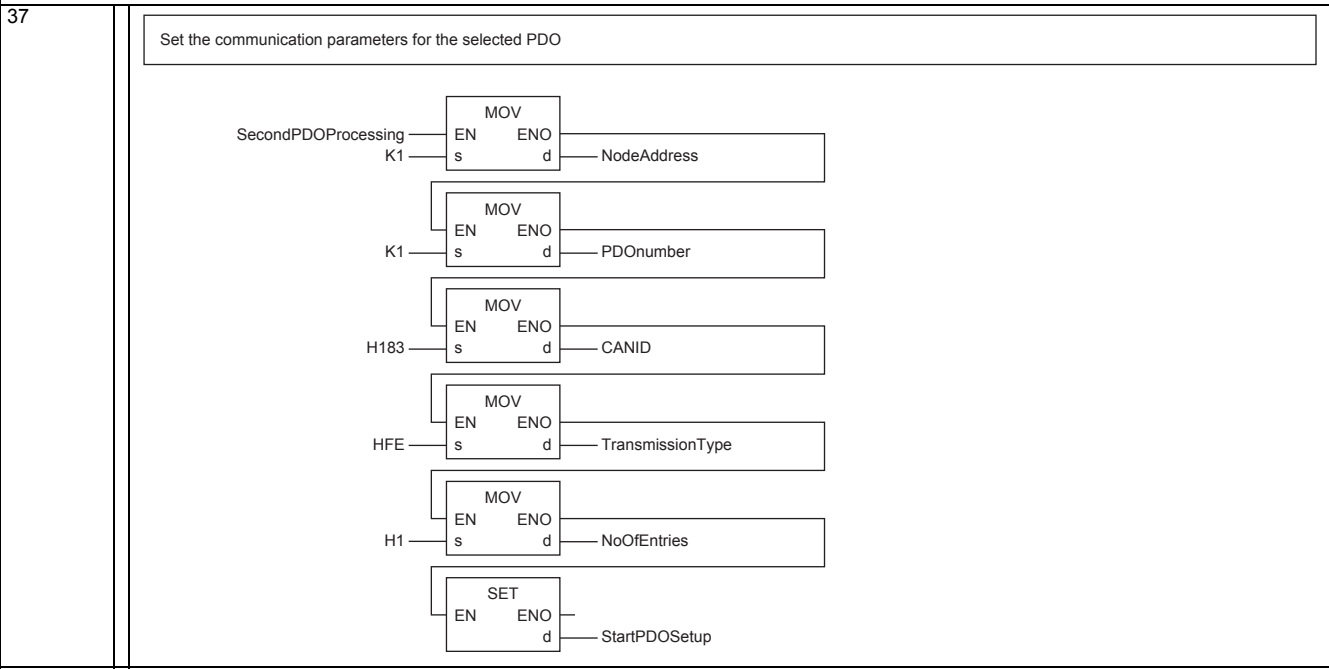

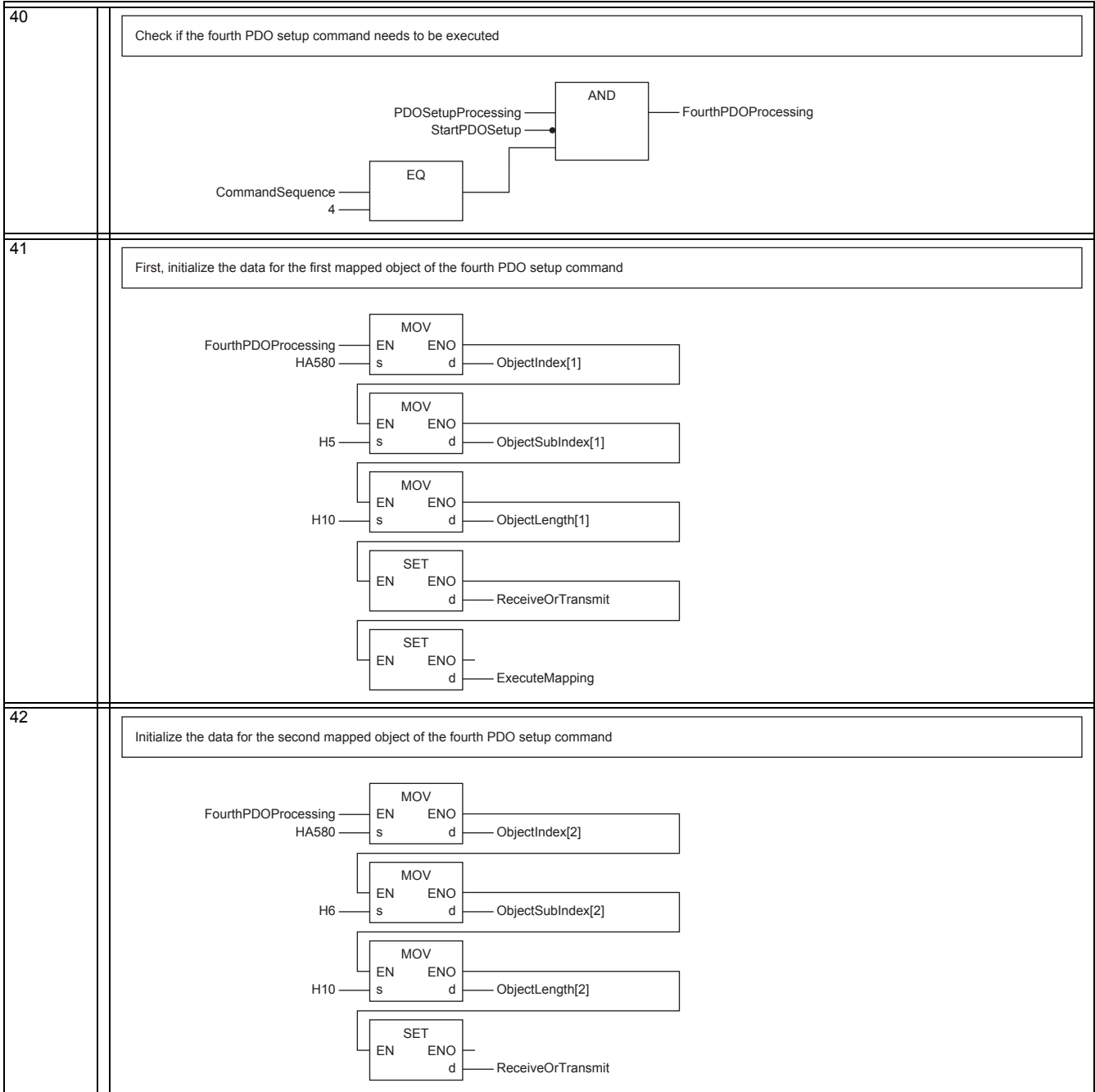

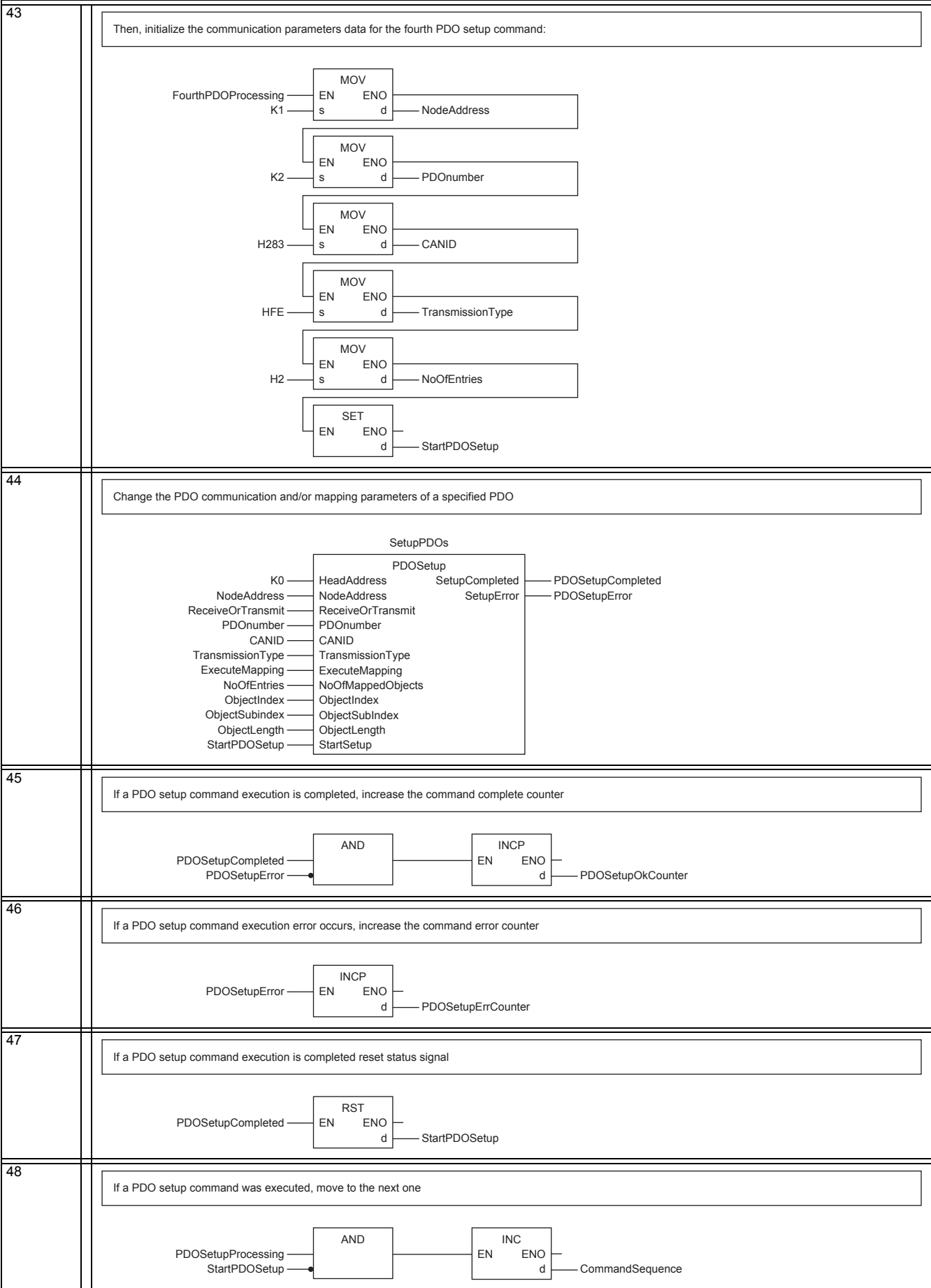

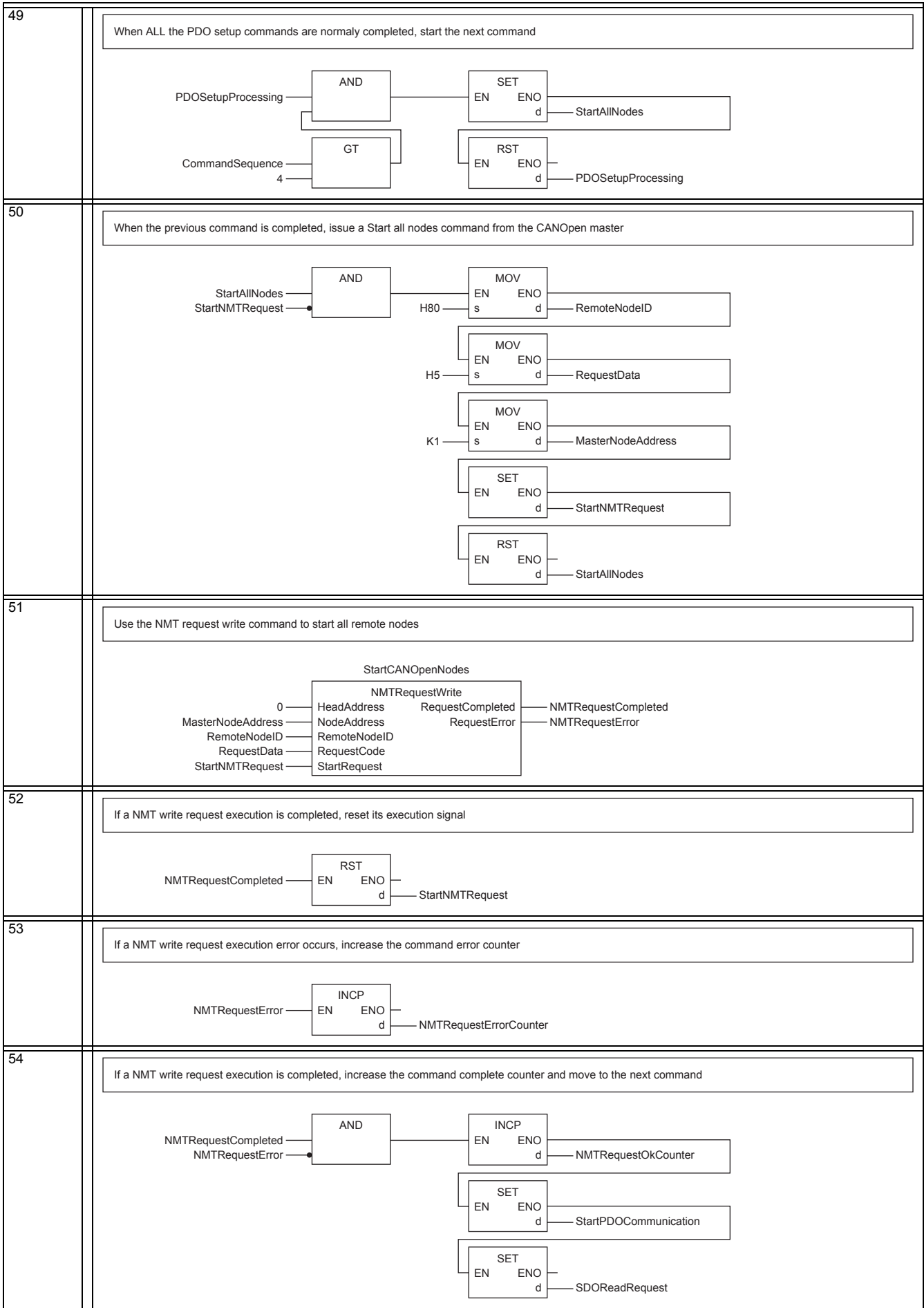

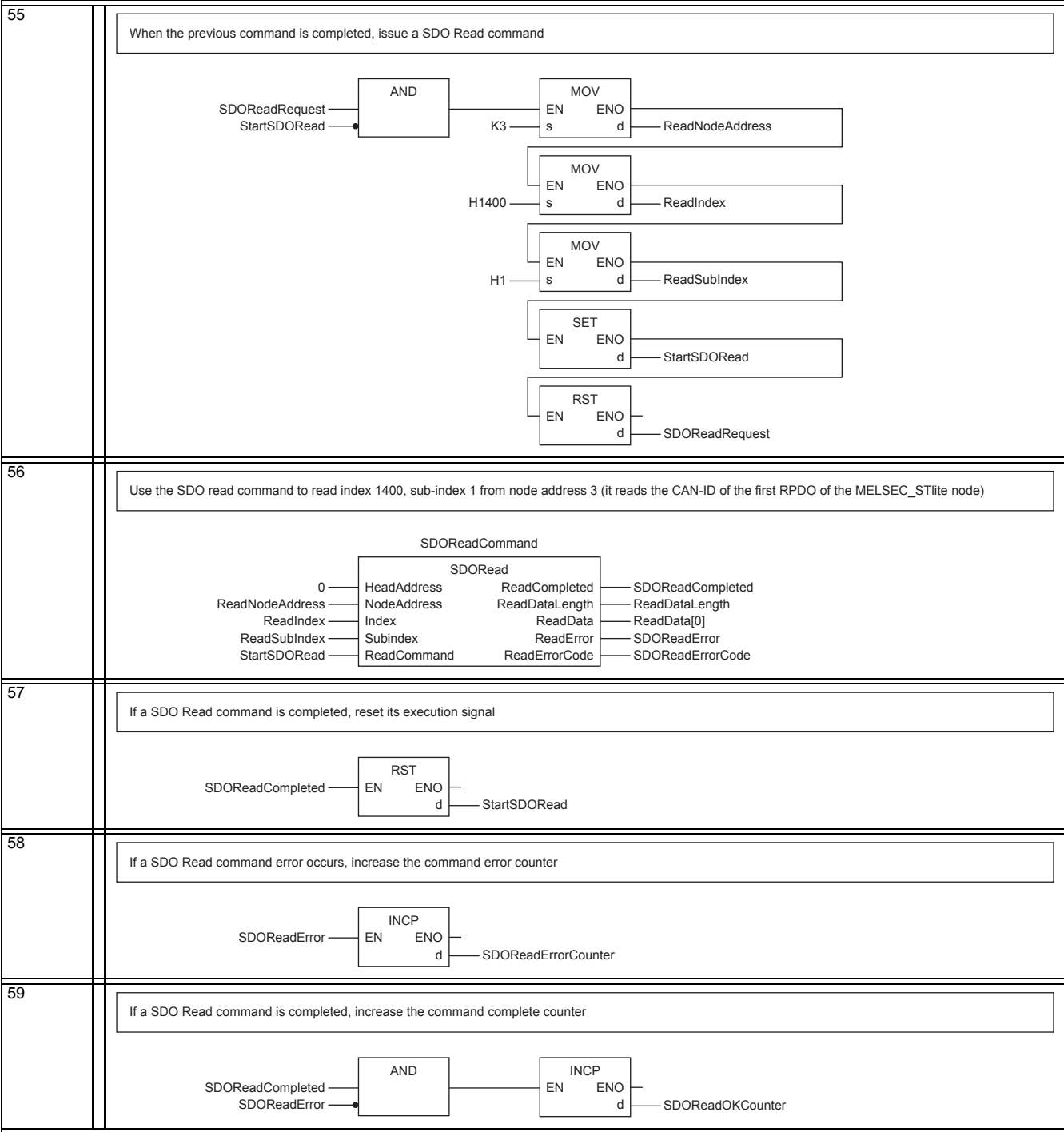

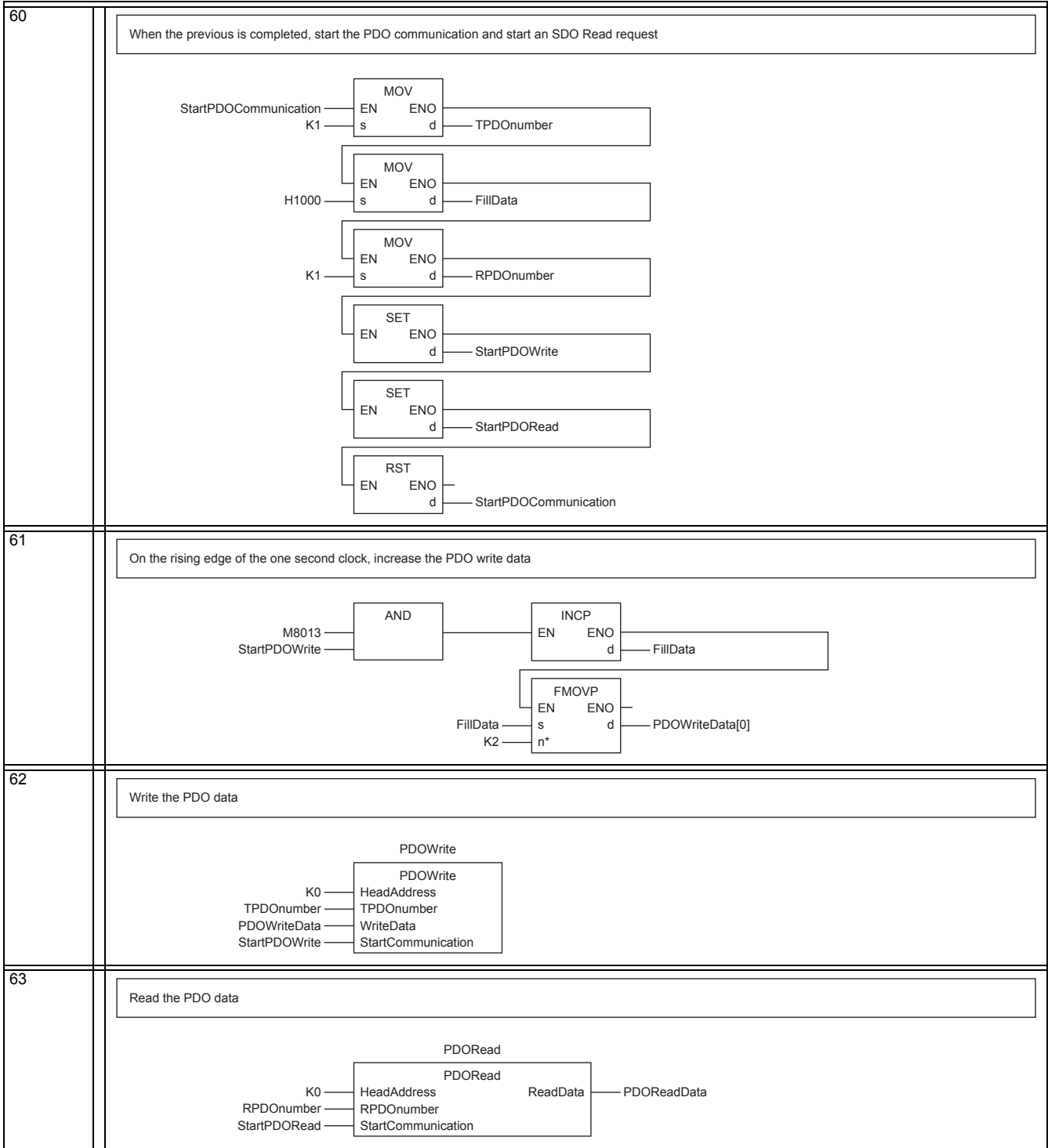



14. Diagnostics

STARTUP AND MAINTENANCE PRECAUTIONS	 WARNING
<ul style="list-style-type: none"> Do not touch any terminal while the PLC's power is on. Doing so may cause electric shock or malfunctions. Before cleaning or retightening terminals, cut off all phases of the power supply externally. Failure to do so may cause electric shock. Before modifying or disrupting the program in operation or running the PLC, carefully read through this manual and the associated manuals and ensure the safety of the operation. An operation error may damage the machinery or cause accidents. 	

STARTUP AND MAINTENANCE PRECAUTIONS	 CAUTION
<ul style="list-style-type: none"> Do not disassemble or modify the PLC. Doing so may cause fire, equipment failures, or malfunctions. For repair, contact your local Mitsubishi Electric representative. Turn off the power to the PLC before connecting or disconnecting any extension cable. Failure to do so may cause equipment failures or malfunctions. Do not drop the product or exert strong impact to it. Doing so may cause damage. Turn off the power to the PLC before attaching or detaching the following devices. Failure to do so may cause equipment failures or malfunctions. <ul style="list-style-type: none"> Peripheral devices, display module, expansion boards, and special adapters Input/output extension units/blocks, FX Series terminal blocks and special function units/blocks Battery and memory cassette 	

14.1 Preliminary Checks

Check the RUN, FROM/TO, Tx/Rx, ERROR and POWER LED status.

1. RUN LED

LED State	Description
OFF	FX3U-CAN is in Layer 2 offline mode.
SINGLE FLASH*1	FX3U-CAN is in CANopen® STOPPED state. Periodically turns ON for 100 ms, and OFF for 1 s.
BLINKING*1	FX3U-CAN is in CANopen® PRE-OPERATIONAL state. Turns ON/OFF in 200 ms intervals.
FLICKERING*1	LSS Services in progress Turns ON/OFF in 50 ms intervals.
ON	<ul style="list-style-type: none"> CANopen® mode: CANopen® OPERATIONAL state Layer 2 mode: Layer 2 online mode

*1. RUN LED has three kinds of flicker states: single flash, blinking, and flickering. This LED flickers as follows.

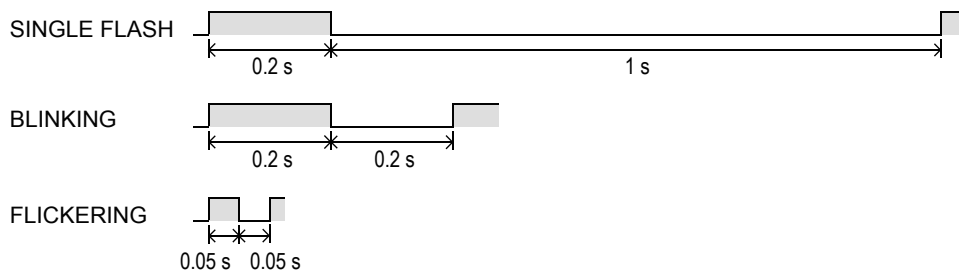

2. FROM/TO LED

LED State	Description
OFF	PLC is not accessing BFM's in FX3U-CAN using FROM/TO instructions or other instructions which specify buffer memory values directly.
ON	PLC is accessing BFM's in FX3U-CAN using FROM/TO instructions or other instructions which specify buffer memory values directly.

3. Tx/Rx LED

LED State	Description
OFF	FX3U-CAN is not transmitting or receiving CAN messages.
ON	FX3U-CAN is transmitting or receiving CAN messages.

4. ERROR LED

LED State	Description
OFF	No error
SINGLE FLASH*1	At least one of the error counters of the module has reached or exceeded the error passive level. Check the following points in the network. <ul style="list-style-type: none"> • Check that the terminating resistors at both ends of the network are connected. • Check that all nodes have the same baud rate setting. • Check that all nodes have a unique Node-Id setting. • Check that the CAN_H, CAN_L and CAN_GND wires are not broken. • Check that the CAN_SHLD is grounded. • Check that the CAN_SHLD is connected at all nodes. • Check that the CAN cable wires do not short circuit other CAN cable wires.
DOUBLE FLASH*1	A NMT guarding failure (NMT-Slave or NMT-Master) or a heartbeat failure has occurred. Check the error status in BFM #29. → Refer to Section 14.2
BLINKING*1	General error has occurred. Check the error status in BFM #29. → Refer to Section 14.2
FLICKERING*1	LSS Services in progress
ON	FX3U-CAN is in BUS-OFF state, or CPU error occurs in PLC main unit. The LED will always be ON if there is a BUS_OFF error, a general error (BFM #29, bit 0), or the FROM/TO watchdog is expired. <ul style="list-style-type: none"> • Check the error status in BFM #29. → Refer to Section 14.2 • Check the ERROR LED of the PLC <ul style="list-style-type: none"> → For FX3G Series PLC, refer to FX3G Hardware Edition → For FX3GC Series PLC, refer to FX3GC Hardware Edition → For FX3U Series PLC, refer to FX3U Hardware Edition → For FX3UC Series PLC, refer to FX3UC Hardware Edition → For FX5U PLC, refer to MELSEC iQ-F FX5U User's Manual (Hardware) → For FX5UC PLC, refer to MELSEC iQ-F FX5UC User's Manual (Hardware) • Check the sequence program for FROM/TO watchdog. → For the FROM/TO watchdog, refer to Section 6.9

*1. ERROR LED has four kinds of flicker states: single flash, double flash, blinking, and flickering. This LED flickers as follows.

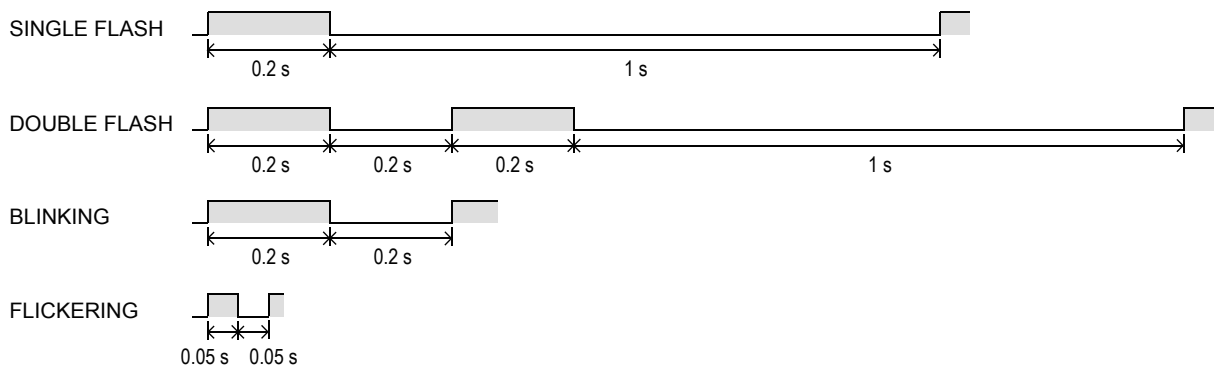

5. POWER LED

LED State	Description
Lit	The power is being correctly supplied from FX3G/FX3U/FX3GC ^{*1} /FX3UC ^{*1} /FX5U ^{*2} /FX5UC ^{*2} PLC via the extension cable to FX3U-CAN.
Otherwise	The power is being incorrectly supplied from FX3G/FX3U/FX3GC ^{*1} /FX3UC ^{*1} /FX5U ^{*2} /FX5UC ^{*2} PLC via the extension cable to FX3U-CAN. <ul style="list-style-type: none"> • Check the connection of the extension cable to the PLC. • Check the power supply of the FX3G/FX3U/FX3GC^{*1}/FX3UC^{*1}/FX5U^{*2}/FX5UC^{*2} PLC. <ul style="list-style-type: none"> → For FX3G Series PLC, refer to FX3G Hardware Edition → For FX3GC Series PLC, refer to FX3GC Hardware Edition → For FX3U Series PLC, refer to FX3U Hardware Edition → For FX3UC Series PLC, refer to FX3UC Hardware Edition → For FX5U PLC, refer to MELSEC iQ-F FX5U User's Manual (Hardware) → For FX5UC PLC, refer to MELSEC iQ-F FX5UC User's Manual (Hardware) → For power supply specifications for FX3U-CAN, refer to Section 2.2

- *1. An FX2NC-CNV-IF or FX3UC-1PS-5V is necessary to connect the FX3U-CAN to an FX3GC/FX3UC Series PLC.
- *2. An FX5-CNV-BUS or FX5-CNV-BUSC is necessary to connect the FX3U-CAN to an FX5U/FX5UC PLC.

14.2 Detail Error Check

Please check the bit status of Error Status in BFM #29.

Note

- The error flags b5, b6, b8, b10, b13 and b15 are latched, and it is necessary to write K0 to the appropriate bit of BFM #29 or the whole BFM, which will clear all latched error flags in BFM #29. All other bits are reset automatically if the cause for the error is resolved.
- In case of a FROM/TO watchdog timer error (bit 7 is ON), the following message will be sent to the network.
If the module is in a CANopen[®] Mode the module will switch to CANopen[®] State Stopped.
→ For the FROM/TO watchdog, refer to Section 6.9
 - When CANopen[®] 405/417 mode is used
FX3U-CAN transmits the EMCY Object (emergency message) on the CAN network.
→ For the EMCY Object (emergency message), refer to Subsection 5.6.13 and Section 6.23
 - When the 11 bit / 29 bit CAN-ID Layer 2 mode is used
FX3U-CAN transmits the PLC RUN>STOP message on the CAN network.
→ For the PLC RUN>STOP message, refer to Section 9.6

Module failures

The module stays in initial status (Displayed in BFM #25). The CANopen[®] configuration may be faulty. Reset the Object Dictionary to default settings using the CIF.

- For Restore Object Dictionary default settings, refer to Section 10.7
- For module restart, refer to Section 6.8

Bit No.	Description	
Bit 0	General error	General error has occurred. This bit is ON if bit 1, 2, 3, 4, 5, 6, 7, 8, 10, 11, 12 or 15 are ON. Check the ON bit.
Bit 1	Hardware error	Hardware error has occurred. If this error flag is not cleared after a module reset (BFM #25 bit 0) or another power cycle, FX3U-CAN is probably damaged. Please contact your local Mitsubishi Electric representative. → For module restart, refer to Section 6.8
Bit 2	Internal power supply error	Internal power supply error has occurred. If this error flag is not cleared after a module reset (BFM #25 bit 0) or another power cycle, FX3U-CAN is probably damaged. Please contact your local Mitsubishi Electric representative. → For module restart, refer to Section 6.8

Bit No.	Description	
Bit 3	CAN bus off error	<p>The FX3U-CAN is bus OFF. The FX3U-CAN has too many transmission errors. Check the following points in the network. And then, turn on the power for PLC again or restart the FX3U-CAN.</p> <p style="text-align: right;">→ For module restart, refer to Section 6.8</p> <ul style="list-style-type: none"> • Check that the terminating resistors at both ends of the network are connected. • Check that all nodes have the same baud rate setting. • Check that all nodes have a unique Node-Id setting. • Check that the CAN_H, CAN_L and CAN_GND wires are not broken. • Check that the CAN_SHLD is grounded. • Check that the CAN_SHLD is connected at all nodes. • Check that the CAN cable wires do not short circuit other CAN cable wires.
Bit 4	FLASH memory error	<p>FLASH memory error has occurred. Invalid data in the Flash memory might be caused by power loss during a write operation to the Flash ROM. If this error flag is not cleared after a module reset (BFM #25 bit 0) or another power cycle, please contact your local Mitsubishi Electric representative.</p> <p style="text-align: right;">→ For module restart, refer to Section 6.8</p>
Bit 5		<ul style="list-style-type: none"> • CANopen[®] modes: Write access while module is in initialisation mode. Write to BFM, after BFM #25 bit 7 is OFF. → For the communication status (BFM #25), refer to Section 6.8 • Layer 2 mode: Invalid write access to configuration BFM while in online/initialisation mode. Do not write to configuration BFM when module is online. Write to configuration BFMs, after switching to configuration mode and off line mode. → For the communication status (BFM #25), refer to Section 6.8 <p>This failure is displayed in BFM #40.</p>
Bit 6	BFM setting error	<p>BFM setting error has occurred. ON when a value that is out of range is written to a BFM. This failure BFM address is displayed in BFM #39. In Layer 2 mode, this bit can not be reset while the module is in online mode.</p> <p style="text-align: right;">→ For BFM #39, refer to Section 6.17</p>
Bit 7	FROM/TO watchdog timer error	<p>FROM/TO watchdog timer expired. Please see the above note. This error flag can be reset by writing to BFM #26.</p> <p style="text-align: right;">→ For the FROM/TO watchdog, refer to Section 6.9</p>
Bit 8	Internal data queue overflow	<p>Internal data queue overflowed. Extreme bus load can cause the internal queues to overflow. Decrease the bus load. At a low baud rate, data exchange that is too fast can overflow the CAN Transmit Buffer (Depends also on the bus-load of the CAN).</p> <p style="text-align: right;">→ For Data Exchange Control flag, refer to Section 6.4</p>
Bit 9	Reserved	
Bit 10	CANopen [®] NMT Error Control failure	<p>CANopen[®] NMT Error Control failure has occurred. At least one of the assigned NMT slaves failed during NMT Error Control.</p> <p style="text-align: right;">→ For NMT Error Control failure, refer to Section 6.24</p>
Bit 11	Baud rate change error	<p>Baud rate change error has occurred. ON when an invalid baud rate is written to BFM #24. In this case, the BFM will keep its former value.</p> <p style="text-align: right;">→ For the baud rate setting, refer to Section 6.7</p>
Bit 12	Node address change error	<p>Node address change error has occurred. ON when an invalid node address is written to BFM #27. In this case, the BFM will keep its former value.</p> <p style="text-align: right;">→ For the node address setting, refer to Section 6.10</p>
Bit 13	CANopen [®] emergency	<p>CANopen[®] emergency message was received from the assigned slave.</p> <p style="text-align: right;">→ For the emergency message, refer to Section 6.23</p>
Bit 14	CAN error passive state	<p>This flag shows the CAN error active state/passive state^{*1}.</p> <p>OFF: Error active state CAN reception error counter value is in the range of K0 to K127.</p> <p>ON: Error passive state CAN reception error counter value is K128. This bit will be reset automatically if the internal error counters return back to below K128.</p> <p style="text-align: right;">→ For the CAN transmission error counter, refer to Section 6.13 → For the CAN reception error counter, refer to Section 6.14</p>
Bit 15	Layer 2 Message specific error	<p>Layer 2 Message specific error exists. Check the Layer 2 Message specific error code in BFM #401 to #442.</p> <p style="text-align: right;">→ For the Layer 2 Message specific error code, refer to Section 9.2</p>

*1. Any CANopen[®] node will check all CAN messages on the bus for errors. Depending on the error state, the action that the node will take is different:

- In error active:
The node will actively mark the frame as invalid.
- In error passive:
The node will not actively mark the frame as invalid to avoid bus disturbance if the node itself has an H/W problem.

Warranty

Please confirm the following product warranty details before using this product.

1. Gratis Warranty Term and Gratis Warranty Range

If any faults or defects (hereinafter "Failure") found to be the responsibility of Mitsubishi occurs during use of the product within the gratis warranty term, the product shall be repaired at no cost via the sales representative or Mitsubishi Service Company. However, if repairs are required onsite at domestic or overseas location, expenses to send an engineer will be solely at the customer's discretion. Mitsubishi shall not be held responsible for any re-commissioning, maintenance, or testing on-site that involves replacement of the failed module.

[Gratis Warranty Term]

The gratis warranty term of the product shall be for one year after the date of purchase or delivery to a designated place. Note that after manufacture and shipment from Mitsubishi, the maximum distribution period shall be six (6) months, and the longest gratis warranty term after manufacturing shall be eighteen (18) months. The gratis warranty term of repair parts shall not exceed the gratis warranty term before repairs.

[Gratis Warranty Range]

- (1) The range shall be limited to normal use within the usage state, usage methods and usage environment, etc., which follow the conditions and precautions, etc., given in the instruction manual, user's manual and caution labels on the product.
- (2) Even within the gratis warranty term, repairs shall be charged for in the following cases.
 1. Failure occurring from inappropriate storage or handling, carelessness or negligence by the user. Failure caused by the user's hardware or software design.
 2. Failure caused by unapproved modifications, etc., to the product by the user.
 3. When the Mitsubishi product is assembled into a user's device, Failure that could have been avoided if functions or structures, judged as necessary in the legal safety measures the user's device is subject to or as necessary by industry standards, had been provided.
 4. Failure that could have been avoided if consumable parts (battery, backlight, fuse, etc.) designated in the instruction manual had been correctly serviced or replaced.
 5. Relay failure or output contact failure caused by usage beyond the specified Life of contact (cycles).
 6. Failure caused by external irresistible forces such as fires or abnormal voltages, and failure caused by force majeure such as earthquakes, lightning, wind and water damage.
 7. Failure caused by reasons unpredictable by scientific technology standards at time of shipment from Mitsubishi.
 8. Any other failure found not to be the responsibility of Mitsubishi or that admitted not to be so by the user.

2. Onerous repair term after discontinuation of production

- (1) Mitsubishi shall accept onerous product repairs for seven (7) years after production of the product is discontinued.
Discontinuation of production shall be notified with Mitsubishi Technical Bulletins, etc.
- (2) Product supply (including repair parts) is not available after production is discontinued.

3. Overseas service

Overseas, repairs shall be accepted by Mitsubishi's local overseas FA Center. Note that the repair conditions at each FA Center may differ.

4. Exclusion of loss in opportunity and secondary loss from warranty liability

Regardless of the gratis warranty term, Mitsubishi shall not be liable for compensation to:

- (1) Damages caused by any cause found not to be the responsibility of Mitsubishi.
- (2) Loss in opportunity, lost profits incurred to the user by Failures of Mitsubishi products.
- (3) Special damages and secondary damages whether foreseeable or not, compensation for accidents, and compensation for damages to products other than Mitsubishi products.
- (4) Replacement by the user, maintenance of on-site equipment, start-up test run and other tasks.

5. Changes in product specifications

The specifications given in the catalogs, manuals or technical documents are subject to change without prior notice.

6. Product application

- (1) In using the Mitsubishi MELSEC programmable logic controller, the usage conditions shall be that the application will not lead to a major accident even if any problem or fault should occur in the programmable logic controller device, and that backup and fail-safe functions are systematically provided outside of the device for any problem or fault.
- (2) The Mitsubishi programmable logic controller has been designed and manufactured for applications in general industries, etc. Thus, applications in which the public could be affected such as in nuclear power plants and other power plants operated by respective power companies, and applications in which a special quality assurance system is required, such as for Railway companies or Public service purposes shall be excluded from the programmable logic controller applications.
In addition, applications in which human life or property that could be greatly affected, such as in aircraft, medical applications, incineration and fuel devices, manned transportation, equipment for recreation and amusement, and safety devices, shall also be excluded from the programmable logic controller range of applications.
However, in certain cases, some applications may be possible, providing the user consults their local Mitsubishi representative outlining the special requirements of the project, and providing that all parties concerned agree to the special circumstances, solely at the users discretion.

Revised History

Date	Revision	Description
4/2012	A	First Edition
12/2013	B	<ul style="list-style-type: none"> • Firmware version 1.10 is supported. <ul style="list-style-type: none"> - The following objects are added: Index H100C, Index H100D, Index H1020, Index H102A - The following Buffer memories are added: BFM #70, BFM #71, BFM #10000 to 10319, BFM #11000 to #11319, BFM #12000 to #12539, BFM #13000 to #13539 - Supports BFM #20 bit 8,9 and 12. - The following error codes are added: H3111, H3121, H8F01 to H8F7F • Default value of communication parameter is added. [Section 5.6] • Default value of mapping parameter is added. • The explanation of Communication Profile Area is modified. [Section 5.6] • The explanation of RPDO/TPDO is modified. [Subsection 5.6.5] • The explanation of SYNC is modified. [Subsection 5.6.7] • The explanation of Node guarding is modified. [Subsection 5.6.8] • The explanation of Time is modified. [Subsection 5.6.10] • The contents of protocol NMT is added. [Subsection 5.8.3] • The contents of NMT slave identification is added. [Subsection 5.8.4] • The explanation of NMT master startup is modified. [Subsection 5.8.5] • The explanation of NMT slave startup is modified. [Subsection 5.8.6] • The explanation of NMT slave assignment is modified. [Subsection 5.8.7] • The contents of NMT Bootup / Error event handling is added. [Subsection 5.8.8] • The explanation of Application Profile CiA[®] 417 V2.1 for Lift Control Systems is modified. [Section 5.10] • The explanation of Flying master is modified. [Subsection 5.8.11] • The explanation of LSS is modified. [Subsection 5.8.12] • The explanation of Configuration manager is modified. [Subsection 5.8.13] • The explanation of Allocation of Buffer Memories is modified. [Chapter 6] • The explanation of CANopen[®] 405 Mode is modified. [Chapter 7] • The explanation of CANopen[®] 417 Mode is modified. [Chapter 8] • The explanation of Pre-defined Layer 2 receive messages is modified. [Subsection 9.3.2] • The contents of CIF Multi SDO read access is added. [Subsection 10.2.2] • The contents of CIF Multi SDO write access is added. [Subsection 10.2.4] • The explanation of Send an Emergency Message is modified. [Section 10.5] • The contents of PLC RUN/STOP is added. [Chapter 11] • Partial correction • Errors are corrected.
4/2015	C	<ul style="list-style-type: none"> • A part of the cover design is changed.
8/2016	D	<ul style="list-style-type: none"> • Firmware version 1.12 is supported. <ul style="list-style-type: none"> - Connection to FX5U/FX5UC PLC. • The contents of power down message is removed.

FX3U-CAN

USER'S MANUAL

MITSUBISHI ELECTRIC CORPORATION

HEAD OFFICE: TOKYO BUILDING, 2-7-3 MARUNOUCHI, CHIYODA-KU, TOKYO 100-8310, JAPAN